

GL900

midi LOGGER

USER'S MANUAL

MANUAL NO. GL900-UM-151

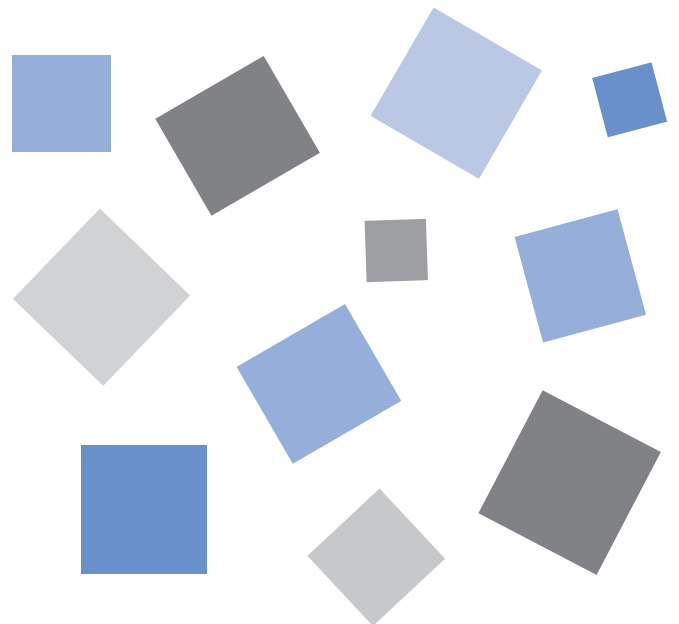

GRAPHTEC

Introduction

Thank you for purchasing the GL900 midi LOGGER.

Please read this manual thoroughly before attempting to use your new product to ensure that you use it correctly and to its full potential.

Notes on Use

Be sure to read all of the following notes before attempting to use the GL900 midi LOGGER.

1. Note on the CE Marking

The GL900 complies with the EN61326 Class A standard based on the EMC directive (89/336/EMC). It also conforms to the EN61010-1 standard based on the LV directive (72/73/EEC).

Although the GL900 complies with the above-mentioned standards, be sure to use it correctly in accordance with the instructions and notes provided in its User's Manual.

Moreover, use of the GL900 by incorrect procedures may result in damage to the GL900 or may invalidate its safeguards. Please confirm all of its notes regarding use and other related information to ensure correct use.

2. Warning

This is a Class A product according to the EMC directive.

In a domestic environment, this product may cause radio interference or may be affected by radio interference to the extent that proper measurement cannot be performed.

3. Notes for Safe Operation

- (1) Be sure to use the Graphtec-supplied AC adapter. In environments where there is a lot of noise or where the power supply is unstable, we recommend that you ground the GL900.

For details, see Section 2.4, "Connecting the Power Cable and Turning on the Power."

- (2) When a high-voltage signal cable has been connected to the main unit's analog signal input terminal, avoid touching the leads of the input terminal's signal cable to prevent electrical shock due to high voltage.
- (3) Ensure that the GL900's power source is positioned so that it can easily be disconnected.

4. Notes on Functions and Performance

- (1) Be sure to connect the main unit to an AC or DC power supply that conforms to the rated range. Connection to a non-rated power supply may cause the main unit to overheat and break down.
- (2) Do not block the vent on the main unit. Continued operation with the vent blocked may cause the main unit to overheat and break down.
- (3) To avoid malfunctions and other damage, avoid using the GL900 in the following locations.
 - Places exposed to high temperature and/or high humidity, such as in direct sunlight or near heating equipment. (Operating range - Temperature: 0 to 40°C (15 to 35°C when battery pack is mounted), Humidity: 5 to 85% RH)
 - Locations subject to excessive salt spray or heavy fumes from corrosive gas or solvents.
 - Excessively dusty locations.
 - Locations subject to strong vibrations or shock.
 - Locations subject to surge voltages and/or electromagnetic interference.
- (4) If the main unit becomes soiled, wipe it off using a soft, dry cloth. Use of organic solvents (such as thinner or benzene) causes deterioration and discoloration of the outer casing.

Introduction

- (5) Do not use the GL900 in the vicinity of other devices which are susceptible to electromagnetic interference.
- (6) Measured results may not conform to the stated specifications if the GL900 is used in an environment which is subject to strong electromagnetic interference.
- (7) Insofar as possible, position the GL900 input signal cables away from any other cables which are likely to be affected by electromagnetic interference.
- (8) For stabilized measurement, allow the GL900 to warm up for at least 30 minutes after turning it on.

To Ensure Safe and Correct Use

- To ensure safe and correct use of the GL900, read this Manual thoroughly before use.
- After having read this Manual, keep it in a handy location for quick reference as needed.
- Do not permit small children to touch the GL900.
- The following describes important points for safe operation. Please be sure to observe them strictly.

Conventions Used in This Manual

To promote safe and accurate use of the GL900 as well as to prevent human injury and property damage, safety precautions provided in this manual are ranked into the five categories described below. Be sure you understand the difference between each of the categories.



DANGER

This category provides information that, if ignored, is highly likely to cause fatal or serious injury to the operator.



WARNING

This category provides information that, if ignored, is likely to cause fatal or serious injury to the operator.



CAUTION

This category provides information that, if ignored, could cause physical damage to the GL450.



HIGH TEMPERATURE

This category provides information that, if ignored, is likely to cause burns or other injury to the operator due to contact with high temperature.





ELECTRICAL SHOCK



This category provides information that, if ignored, is likely to expose the operator to electrical shock.

Description of Safety Symbols





The  symbol indicates information that requires careful attention (which includes warnings). The point requiring attention is described by an illustration or text within or next to the  symbol.



The  symbol indicates action that is prohibited. Such prohibited action is described by an illustration or text within or next to the  symbol.



The  symbol indicates action that must be performed. Such imperative action is described by an illustration or text within or next to the  symbol.

Safety Precautions

WARNING

Be sure to securely connect the GL900's power cord.

- After checking that the Power switch is turned off, connect the power cord's female plug to the GL900 and then connect its male plug into the electrical socket.
- Before running the GL900, be sure to ground the GND terminal to avoid electrical shock and fire hazards. For grounding, use a ground wire with a diameter of at least 0.75 mm².
When using the GL900 in an environment where grounding is not possible, ensure that the voltage to be measured is no greater than 50 V (DC or rms).



Securely connect the power cord
Make sure that the socket has a good protective ground

If the GL900 generates smoke, is too hot, emits a strange odor, or otherwise functions abnormally, turn off its power and unplug its power cord from the electrical socket.

- Use of the GL900 in such status may result in a fire hazard or electrical shock.
- After checking that smoke is no longer being generated, contact your sales representative or nearest Graphtec vendor to request repair.
- Never try to perform repair yourself. Repair work by inexperienced personnel is extremely dangerous.



Amateur repair prohibited

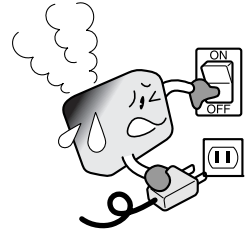

Before turning on the GL900, ensure that the electric socket's supply voltage conforms to the GL900's power rating.

- Use of a different supply voltage may cause damage to the GL900 or a fire hazard due to electrical shock or current leakage.



Use of a different supply voltage prohibited

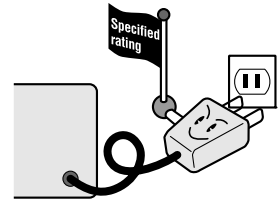

Never disassemble or remodel the GL900.

- Such action may cause a fire hazard due to electric shock or current leakage.
- Contact with a high-voltage component inside the GL900 may cause electric shock.
- If repair is required, contact your sales representative or nearest Graphtec vendor.



No disassembly



Avoid using the GL900 in extremely dusty or humid places.

- Such use may cause a fire hazard due to electrical shock or current leakage.



Use prohibited



Watch out for electrical shock

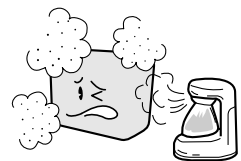

Safety Precautions

WARNING

Avoid using the GL900 in places where it may be exposed to water such as bathrooms, locations exposed to wind and rain, and so on.



Avoid water



Watch out for electrical shock

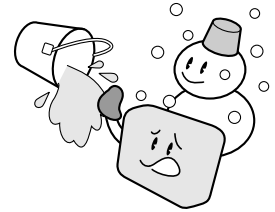

Prevent dust or metallic matter from adhering to the power supply connector.

- Adhesion of foreign matter may cause a fire hazard due to electrical shock or current leakage.



No foreign matter



Watch out for electrical shock

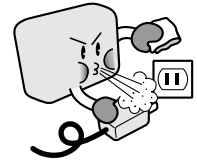

Never use a damaged power cord.

- Use of a damaged cord may result in a fire hazard due to electrical shock.
- If the cord becomes damaged, order a new one to replace it.



Unplug the power cord from the socket

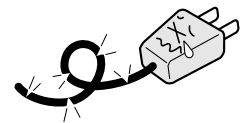

Safety Precautions

CAUTION

Do not use or store the GL900 in a location exposed to direct sunlight or the direct draft of an air conditioner or heater.

- Such location may impair the GL900's performance.

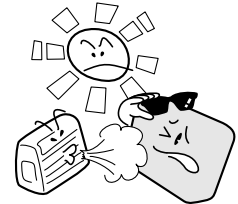

Do not place coffee cups or other receptacles containing fluid on the GL900.

- Fluid spilling inside the GL900 may cause a fire hazard due to electrical shock or current leakage.



Avoid fluids



Watch out for electrical shock



Do not use the GL900 in a location subject to excessive mechanical vibration or electrical noise.

- Such location may impair the GL900's performance.



Use prohibited

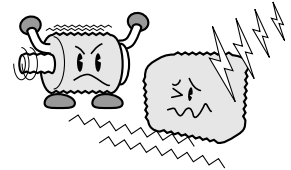

To insert or disconnect the power cord or a signal input cable, grasp the power cord's plug or the signal input cable's connector.

- Pulling the cord/cable itself damages the cord/cable, resulting in a fire hazard or electrical shock.



No pulling

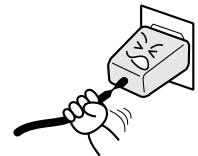

If fluid or foreign matters enters inside the GL900, turn off the Power switch and disconnect the power cord from the electrical socket.

- Use in such status may cause a fire hazard due to electrical shock or current leakage.
- Contact your sales representative or nearest Graphtec vendor to request repair.



Unplug the power cord from the socket

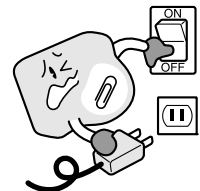

Do not input voltage that exceeds the permissible input voltage range that is specified on the GL900's label.

- Exceeding the specified voltage input range may cause electrical shock or a fire hazard.



Use prohibited

Safety Precautions

CAUTION

Do not attempt to lubricate the GL900's mechanisms.

- Such action may cause the GL900 to break down.



No lubrication

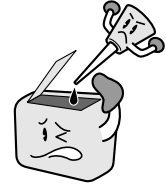

Never clean the GL900 using a volatile solvent (such as thinner or benzene).

- Such action may impair the GL900's performance.
- Clean off any soiled areas using a soft dry cloth.



No volatile solvents

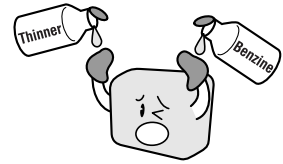

CONTENTS

Introduction	i
To Ensure Safe and Correct Use	iii
Conventions Used in This Manual	iii
Description of Safety Symbols	iii
Safety Precautions	iv

General Description 1-1

1.1 Overview	1-2
1.2 Features	1-2
Input	1-2
Display & Operation	1-2
Data Capture	1-2
Data Control & Processing	1-2
1.3 Operating Environment	1-3
Ambient Operating Conditions	1-3
Warming-up Before Use	1-3
Configuration When in Use	1-3
1.4 Notes on Temperature Measurement	1-4
1.5 Notes on Using the Monitor	1-4
1.6 Changing the Display Language	1-4

Checks and Preparation 2-1

2.1 Checking the Outer Casing	2-2
2.2 Checking the Accessories	2-2
2.3 GL900 Part Names and Functions	2-3
2.4 Connecting the Power Cable and Turning on the Power	2-4
Connecting to an AC Power Supply	2-4
Connecting to a DC Power Supply	2-5
2.5 Connecting the Signal Input Cables	2-6
Terminal Configuration and Signal Types	2-6
Connection diagram	2-6
2.6 Logic Alarm Cable Connection and Functions	2-7
Circuit Example of Relay Drive by Alarm Output	2-7
2.7 Attaching USB Memory	2-9
Inserting a USB Memory	2-9
2.8 Connecting to a PC	2-10
Connection Using a USB Cable	2-10
LAN Connection	2-11
2.9 Using the Battery Pack (Option)	2-12
Mounting the Battery Pack	2-12
Charging the Battery	2-13
2.10 Connecting the Humidity Sensor (Option)	2-14
2.11 Precautions to Observe When Performing Measurement	2-20
2.12 Noise Countermeasures	2-21
2.13 Setting the Date and Time	2-22

How to Recharge the Rechargeable Battery 2-22
 How to Set the Date and Time 2-22

Settings and Measurement 3-1

3.1 Window names and functions 3-2
3.2 Key Operation 3-4
 (1) CH GROUP 3-4
 (2) SPAN/TRACE/POSITION 3-5
 (3) TIME/DIV 3-5
 (4) MENU 3-6
 (5) QUIT (LOCAL) 3-6
 (6) Direction keys 3-6
 (7) ENTER 3-7
 (8) FAST FORWARD key (KEY LOCK) 3-7
 (9) START/STOP (USB Drive Mode) 3-7
 (10) REVIEW 3-8
 (11) DISPLAY 3-9
 (12) CURSOR (ALARM CLEAR) 3-10
 (13) FILE 3-10
 (14) NAVI 3-11
 Basic Procedures Used in Settings 3-11
3.3 Operation Modes 3-12
 (1) Free Running 3-12
 (2) Capturing 3-13
 (3) Dual View Replaying 3-13
 (4) Replaying 3-14
3.4 Setting Menus 3-15
3.5 WEB Server Function 3-38

Specifications 4-1

4.1 Standard Specifications 4-2
 Standard Specifications 4-2
 Internal memory devices 4-3
 PC Interface 4-3
 Monitor 4-3
 Input Unit Specifications 4-4
4.2 Function Specifications 4-5
 Function Specifications 4-5
 Trigger Functions 4-5
 External Input/Output Functions 4-6
4.3 Accessory/Option Specifications 4-7
 Control Software 4-7
 Accessories 4-7
 Battery Pack B-517 (Option) 4-7
 Humidity Sensor B-530 (Option) 4-8
 Options 4-8
4.4 External Dimensions 4-9

Index I-1

CHAPTER 1

General Description

This chapter provides a general description of the GL900 and its features.

- 1.1 Overview**
- 1.2 Features**
- 1.3 Operating Environment**
- 1.4 Notes on Temperature Measurement**
- 1.5 Notes on Using the Monitor**
- 1.6 Changing the Display Language**

1.1 Overview

The GL900 (with color monitor and internal memory) are compact, lightweight, 8 channel data loggers.

GL900 are also equipped with an internal flash memory to store data and enable the direct capture of a large volume of data to USB memory.

Furthermore, the data loggers are equipped with USB and Ethernet interfaces to a PC to enable system configurations according to your application.

The Ethernet feature includes WEB and FTP server and NTP client functions which allow monitoring from a remote location, data transfer, and automatic time synchronization.

1.2 Features

Input

- (1) The input terminals come in two types: easy-to-connect BNC connectors and M3 screw type terminals, which facilitate wiring of thermocouples.
- (2) All channels are isolated, enabling measurement of signals of different references.

Display & Operation

- (1) With the GL900's 5.7-inch TFT color liquid crystal display, you can confirm the waveforms of measured data and each channel's settings at a glance.
- (2) Easy operation is achieved through a straightforward menu structure and key allocation which resembles mobile phones.
- (3) The relationships between timers and triggers are displayed graphically in an easy-to-understand manner.

Data Capture

- (1) Data can be saved to the internal flash memory or external USB memory. The saved data will be retained even after the power is turned off.
- (2) The internal flash memory can be used with disk images thus multiple data items can be maintained.
- (3) Setting the data capture destination to the internal RAM enables quick capture of data. After checking the captured data, you can save it to the internal flash memory or USB memory if required.

Data Control & Processing

- (1) The application software provided lets you set conditions and monitor data on a PC.
- (2) The USB drive mode function enables the GL900's internal flash memory to be recognized as an external drive by your PC. (Connect the GL900 to your PC and turn on the power supply to the GL900 while holding down the [START] key.)
- (3) Captured data can be read from the application software to files and displayed for processing.
- (4) Data can be transferred off-line to a computer using USB memory.
- (5) The WEB server function enables control and monitoring from a remote location without using dedicated software.
- (6) The FTP server function enables handling internal memory and USB memory data from a PC.
- (7) The NTP client function enables adjusting the time according to the NTP server.

1.3 Operating Environment

This section explains the operating environment for the GL900.

Ambient Operating Conditions

- (1) Ambient temperature and humidity (the GL900 must be operated within the following ranges.)
 - Temperature range: 0 to 40°C (15 to 35°C when battery pack is mounted)
 - Humidity range: 5 to 85% RH
- (2) Environment (do not use in the following locations.)
 - A Location such as being exposed to direct sunlight
 - Locations exposed to salty air, corrosive gases, or organic solvents
 - Dusty locations
 - Locations subject to vibration or impact
 - Locations subject to voltage surge or electromagnetic interference such as lightning or electric furnaces
- (3) Installation category
 - The GL900 conforms to the IEC 60-664-1 installation category II
- (4) Measurement category
 - Warning: This equipment is classified as measurement category I, and must not be used within measurement category II, III and IV.

CHECKPOINT

If condensation occurs...

Condensation occurs in the form of water droplets on the device surfaces and interior when the GL900 is moved from a cold to a warm location. Using the GL900 with condensation will cause malfunctioning. Wait until the condensation has disappeared before turning on the power.

Warming-up Before Use

The GL900 should be allowed to warm up with the power turned on for approximately 30 minutes to ensure that it operates according to the specified performance.

Configuration When in Use

Use the GL900 standing upright or at an angle, being set on the stand.

Usage Configuration

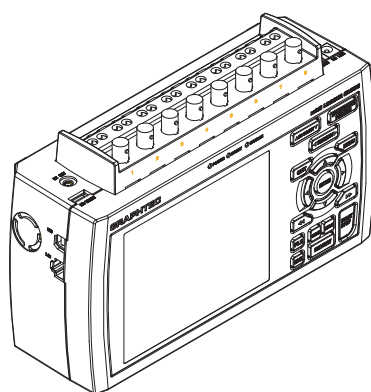

Standing upright

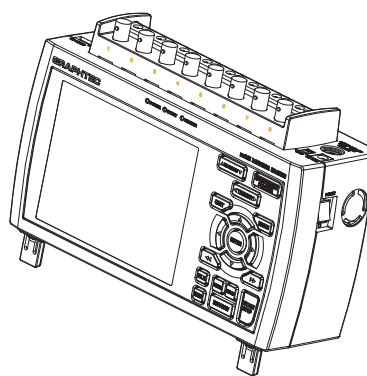

Standing at an angle, being set on the stands

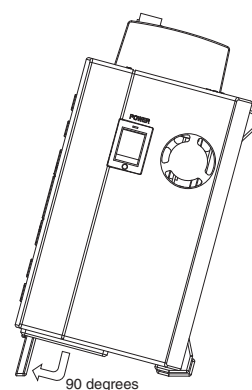

How to open the stands

 **CAUTION**

Do not block the air vent on the GL900, as this will cause malfunctioning. Measurement accuracy may not be satisfactory if the system is used in a condition other than described above. Use both the stands of the GL900 when you use it at an angle. Otherwise, the unit will fall down. Open both the stands before use as shown in this figure.

1.4 Notes on Temperature Measurement

Please observe the following precautions when performing temperature measurement.

- (1) Do not use a thick lead with high heat discharge (0.65 or less is recommended).
- (2) Do not block the air vents. Always provide a space of at least 30 cm on all sides of the GL900.
- (3) For stabilized temperature measurement, allow the GL900 to warm up for at least 30 minutes after turning it on.
- (4) Exposure of the input terminals to direct drafts, direct sunlight, or abrupt changes in temperature may impair the equilibrium of the input parts and result in measurement errors. To measure temperature in such an environment, take appropriate countermeasures such as changing the installation site of the GL900.
- (5) To conduct measurement in noisy environments, connect the GL900's GND terminal to ground (refer to page 2-16).
- (6) If measured values fluctuate due to noise, set to a slower sampling speed (refer to page 3-23).

1.5 Notes on Using the Monitor

The monitor is an LCD display unit, and so the display will vary depending on the operating environment.

 **CHECKPOINT**

If the screen saver function is used, it will operate and clear the screen if no operations are performed during the preset time. If the screen saver operates, press any key to restore the display.

 **CAUTION**

- Condensation may form on the LCD screen if the GL900 is moved from a cold to a warm location. If this occurs, wait until the LCD screen warms up to room temperature.
 - The LCD screen is manufactured to extremely high precision. Black dots may appear, or red, blue, and green dots may not disappear. Likewise, streaks may appear when viewed from certain angles. These phenomena are due to the LCD screen construction, and are not signs of a fault.
-

1.6 Changing the Display Language

You can choose the language displayed on the screen. The default display language is set to English when the GL900 is shipped overseas. To change the display language, see the instructions in "OTHR:Language".

CHAPTER 2

Checks and Preparation

This chapter explains how to check the GL900's external casing and accessories, and how to prepare the GL900 for operation.

- 2.1 Checking the Outer Casing**
- 2.2 Checking the Accessories**
- 2.3 GL900 Part Names and Functions**
- 2.4 Connecting the Power Cable and Turning on the Power**
- 2.5 Connecting the Signal Input Cables**
- 2.6 Logic Alarm Cable Connection and Functions**
- 2.7 Attaching USB Memory**
- 2.8 Connecting to a PC**
- 2.9 Using the Battery Pack (Option)**
- 2.10 Connecting the Humidity Sensor (Option)**
- 2.11 Precautions to Observe When Performing Measurement**
- 2.12 Noise Countermeasures**
- 2.13 Setting the Date and Time**

2.1 Checking the Outer Casing

After unpacking, check the GL900's outer casing before use. In particular, please check for the following:

- Surface scratches
- Other flaws such as stains or dirt

2.2 Checking the Accessories

After unpacking, check that the following standard accessories are included.

Standard Accessories

Item	Remarks	Quantity
Quick Start Guide	GL900-UM-80x	1
CD-ROM	User's Manual, Application software	1
AC cable/AC adapter	100 to 240 VAC, 50/60 Hz	1

Optional Accessories

Item name	Model	Description
Battery pack	B-517	7.4 V/2200 mAh*1
DC drive cable	B-514	2 m, bare tips
Humidity sensor	B-530	3 m, with dedicated power connector
Logic alarm cable	B-513	2 m, bare tips
Safe probe	RIC-141	1:1, 42pF
BNC-BNC cable	RIC-112	1.5 m
BNC-banana cable	RIC-113	1.5 m
BNC- alligator clip cable	RIC-114	1.5 m
K-type thermocouple (needle type probes)	RIC-410	1.1 m
K-type thermocouple (stationary surface probes)	RIC-420	1.1 m
K-type thermocouple (stationary surface L probes)	RIC-430	1.1 m

**1: Two battery packs (B-517: option) are required for the GL900 to run on batteries.*

For details, see Section 2.9, "Using the Battery Pack (B-517: Option)".

2.3 GL900 Part Names and Functions

This section describes the names and function of parts of the GL900.

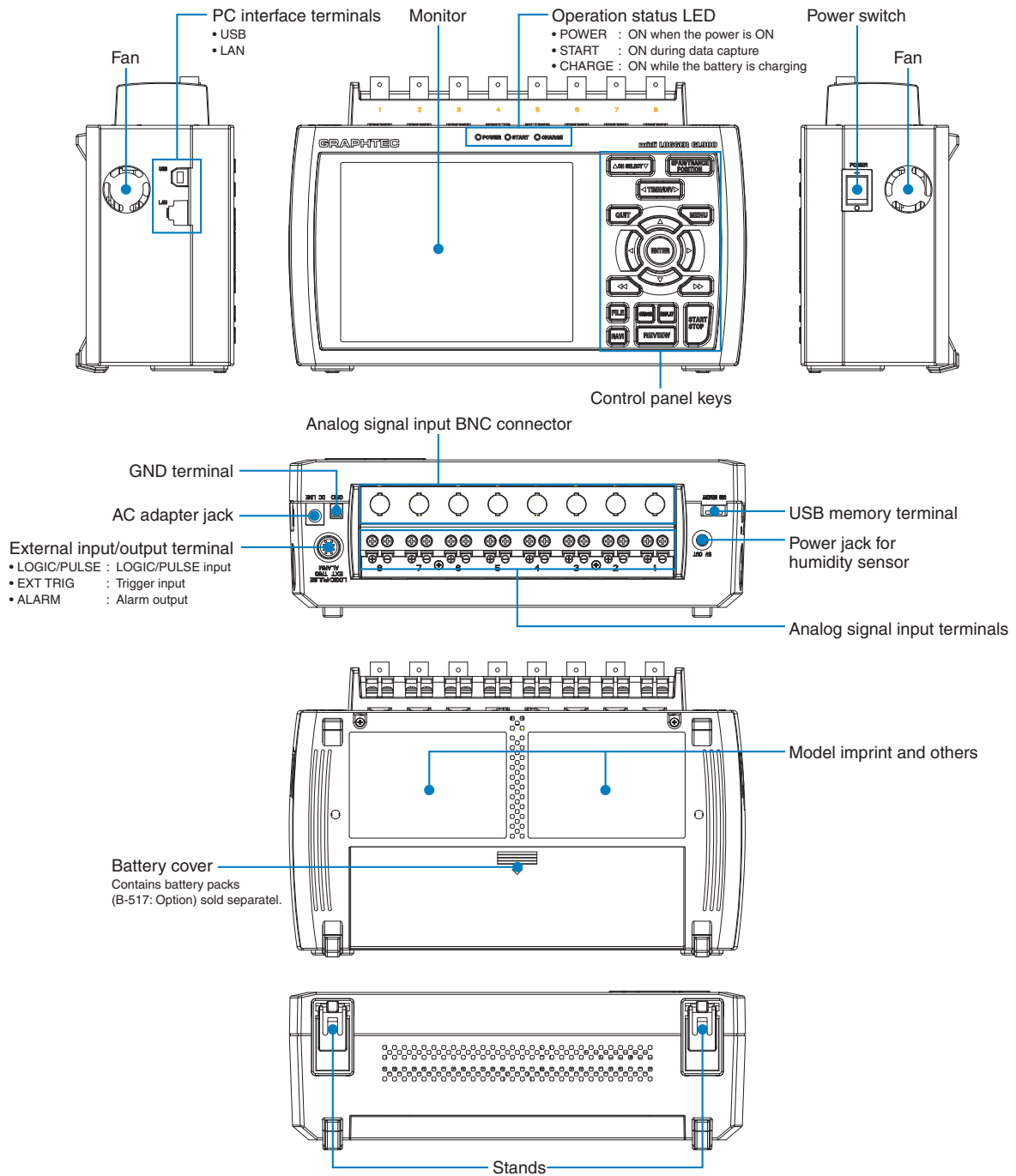

Before using the stands, read the precautions provided in Section 1.3 "Operating Environment".

2.4 Connecting the Power Cable and Turning on the Power

This section describes how to connect the power cable and turn on the power. The connection method will vary depending on the type of power supply used.

Connecting to an AC Power Supply

Use the AC cable and AC adapter that are provided as accessories.

⚠ CAUTION

Be sure to use the AC adapter that is supplied as a standard accessory.

- (1) Plug the AC cable into the AC adapter.

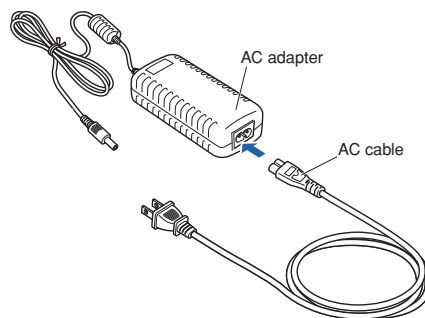

- (2) Connect the output side of the AC adapter to the connector on the GL900.

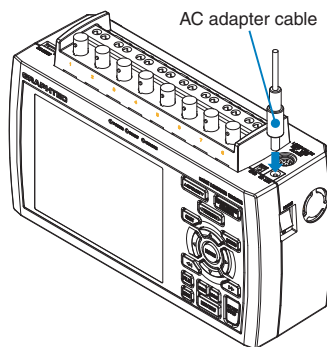

- (3) Using the flat-blade screwdriver, press against the minus (-) button above the GND terminal, while connecting the grounding cable to the GL900. Connect the other end of the cable to ground.

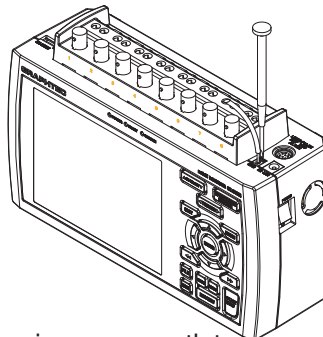

- (4) Plug the AC cable into the mains power outlet.
- (5) Press the power switch on the GL900 to the ON side to turn on the power.

⚠ CAUTION

Always connect the GND terminal and refer to the safety precautions. The GL900 must be grounded even when connected to other devices and sharing a common ground level.

Connecting to a DC Power Supply

Use the optional DC drive cable (B-514: option).

⚠ CAUTION

Use a power supply within the 8.5 to 24 VDC range.

- (1) Configure the tip of the DC drive cable (B-514: option, 2m) to enable it to be connected to the DC power supply.
- (2) Connect the DC output side to the power supply connector on the GL900.

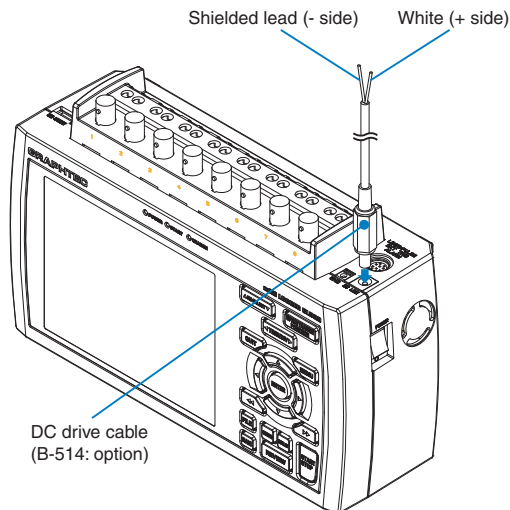

- (3) Using the flat-blade screwdriver, press against the minus (-) button above the GND terminal, while connecting the grounding cable to the GL900. Connect the other end of the cable to ground.

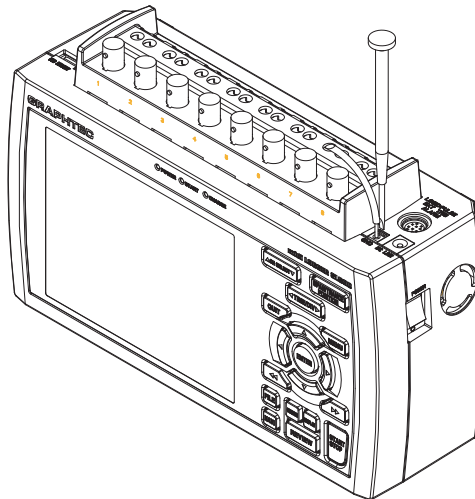

- (4) Connect the DC input side to the DC power supply.

⚠ CAUTION

Be sure to check the polarity of the wire tips when performing wiring.

- (5) Press the power switch on the GL900 to the ON side to turn on the power.

⚠ CAUTION

Always connect the GND terminal and refer to the safety precautions. The GL900 must be grounded even when connected to other devices and sharing a common ground level.

2.5 Connecting the Signal Input Cables

This section describes how to connect the signal input cables.

Terminal Configuration and Signal Types

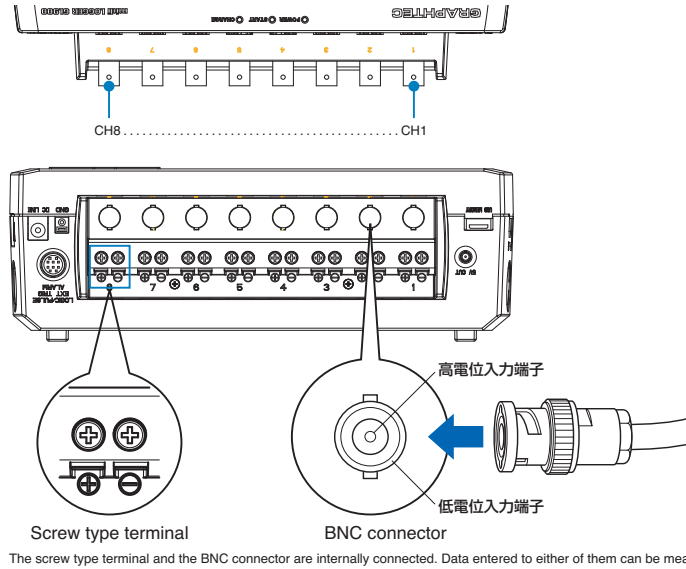

CAUTION

The screw type terminal and the BNC connector of the same channel are connected to each other. Do not input signals to the screw type terminal and the BNC connector of the same channel at the same time. Doing so may cause damage to the measured device.

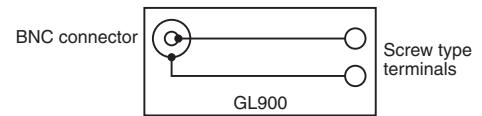

Connection diagram

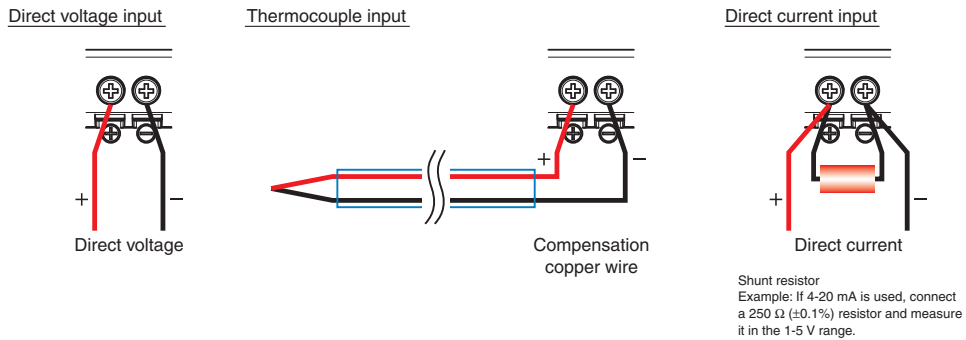

CAUTION

Make sure that the GL900 is not pulled by signal input cables when you connect them. The GL900 may fall down if it is pulled.

- + High-voltage terminal (terminal for high-voltage input signals)
- Low-voltage terminal (terminal for low-voltage input signals)

Item	Description
Input configuration	Isolated input
Analog voltage	20, 50, 100, 200, 500 mV/F.S.; 1, 2, 5, 10, 20, 50, 100, 200, 500V/F.S.; 1-5V
Thermocouples	K, J, E, T, R, S, B, N, W (WRe 5-26)
A/D resolution	16-bit
Filter	Off, Line, 5, 50, 500Hz

2.6 Logic Alarm Cable Connection and Functions

The logic alarm cable (B-513: option) enables logic/pulse input, external trigger input, and alarm signal output.

Connect the logic alarm cable (B-513: option) to the external input/output terminal as shown below.

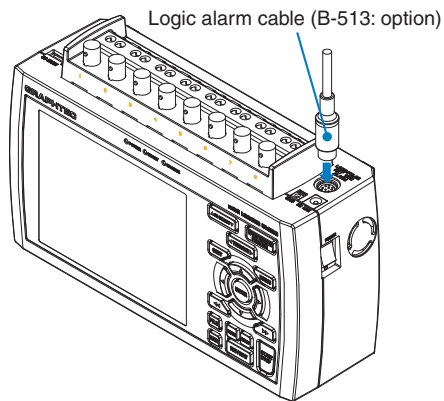

Logic/Pulse Specifications

Item	Description
Number of input channels	4
Input voltage range	0 to +24V max. (single-ended ground input)
Threshold level	Approx. +2.5V
Hysteresis	Approx. 0.5 V (+2.5 to +3 V)

*Switch between logic and pulse input.

Trigger Input Specifications

Item	Description
Number of input channels	1
Input voltage range	0 to +24V max. (single-ended ground input)
Threshold level	Approx. +2.5V
Hysteresis	Approx. 0.5 V (+2.5 to +3 V)

Alarm Output Specifications

Item	Description
Number of output channels	4
Output format	Open collector output +5 V, 10 K Ω pull-up resistance Contact capacity 5 V to 24 V, 100 mA or below

Circuit Example of Relay Drive by Alarm Output

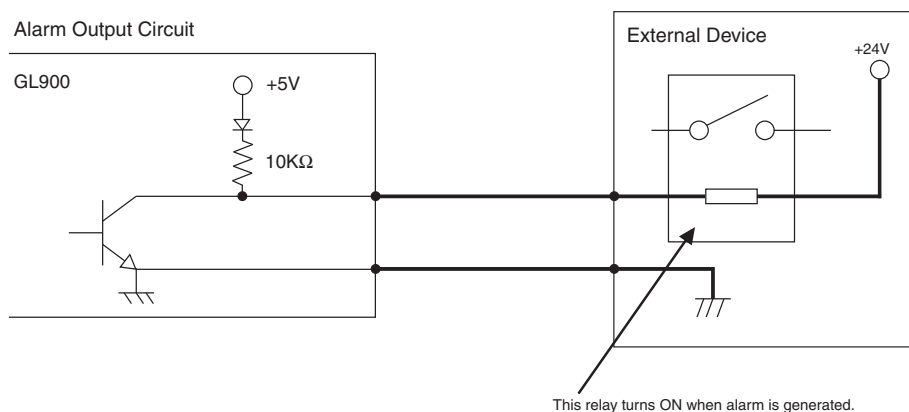

Wiring

Cable tips are bare tips. Perform wiring for the necessary functions.

Signal Name	Channel Number	Wire Color
Logic/Pulse output	1	Orange with red dotted line
	2	Orange with black dotted line
	3	Grey with red dotted line
	4	Grey with black dotted line
Alarm output	1	White with red dotted line
	2	White with black dotted line
	3	Yellow with red dotted line
	4	Yellow with black dotted line
Trigger input		Pink with red dotted line
GND		Pink with black dotted line
		Shielded

*Switch between logic and pulse.

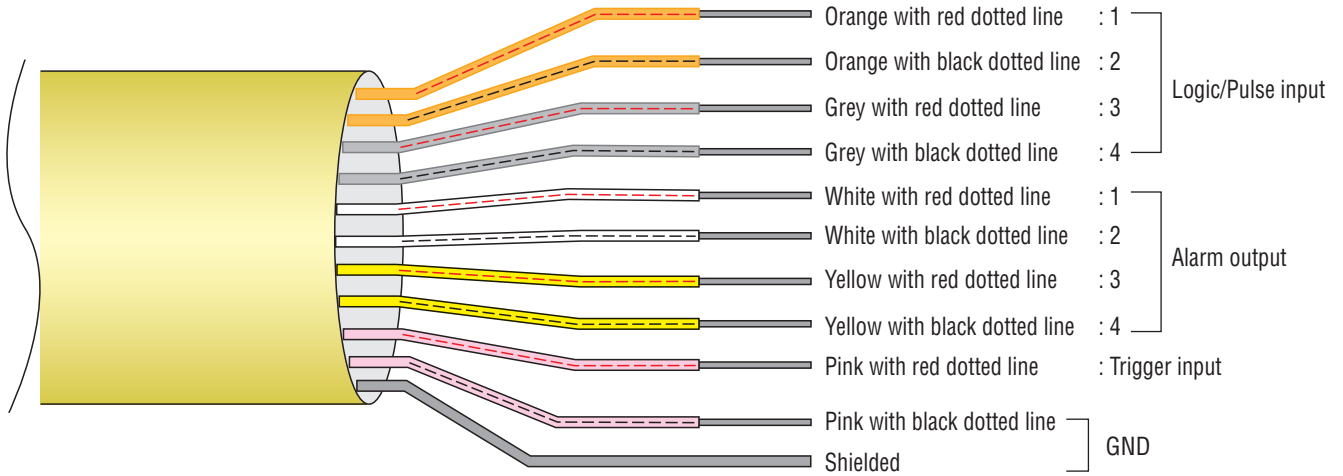

2.7 Attaching USB Memory

Attaching USB memory to the GL900 allows you store measured data directly.

CAUTION

Adequate precautions against static electricity must be taken when handling USB memory.

Inserting a USB Memory

Attach the USB memory to the USB memory terminal.

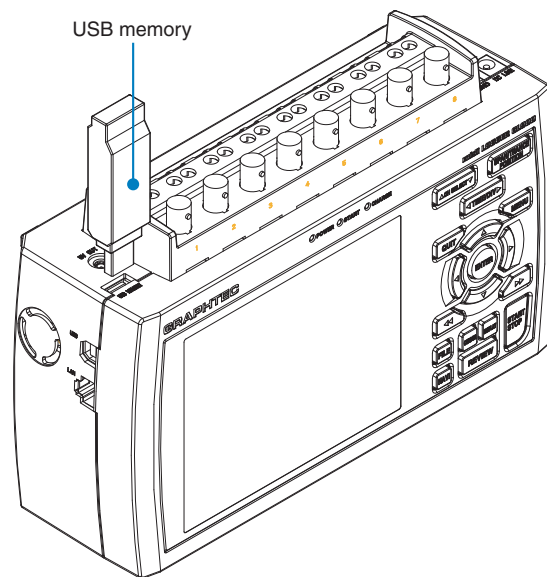

CAUTION

When you attach the USB memory to GL900, be careful during handling so as not to bump or drop the unit.

<Specifications of supported USB memory>

- Power source : +5 V
 - Power consumption : 250 mA or below
 - Capacity : No limit (except each file must be within 2 GB)
- * USB memory with security functions such as fingerprint authentication cannot be used.

2.8 Connecting to a PC

Use the USB, LAN Interface to connect the GL900 to a PC.

Connection Using a USB Cable

Use the USB cable to connect the GL900 to a PC.

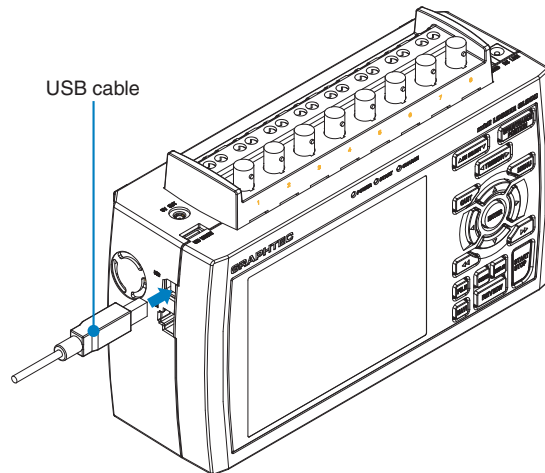

CHECKPOINT

If the USB cable is used, the USB driver must be installed in your PC. Please refer to "Application Software Instruction Manual" for the installation procedure. There is "Application Software Instruction Manual" in an attached CD-ROM.

CAUTION

The USB connector is adjacent to the LAN connector. Make sure the cable is inserted into the correct connector.

● Use an A-B type USB cable to connect the GL900 to a PC

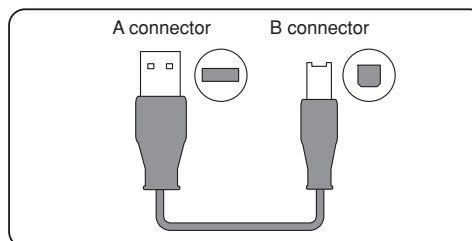

LAN Connection

Use a LAN cable to connect the GL900 to a PC.

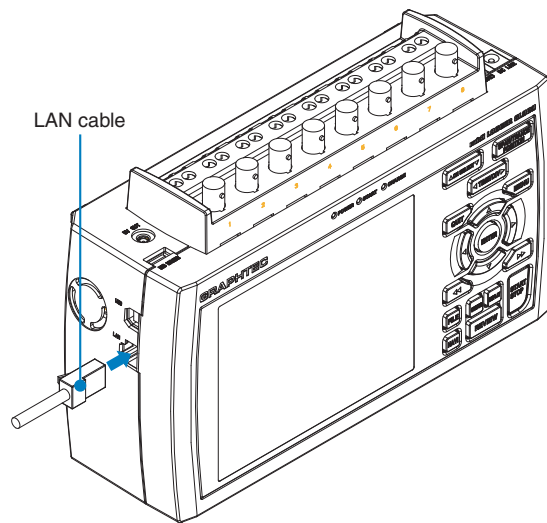

Cable Types

- Use a crossing cable when connecting directly to a PC, without using a hub.

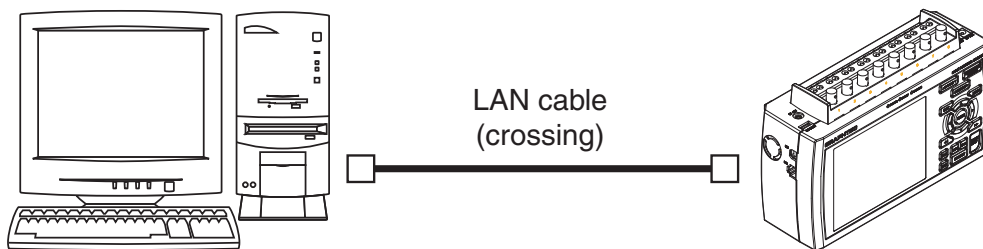

- Use a straight cable when using a hub.

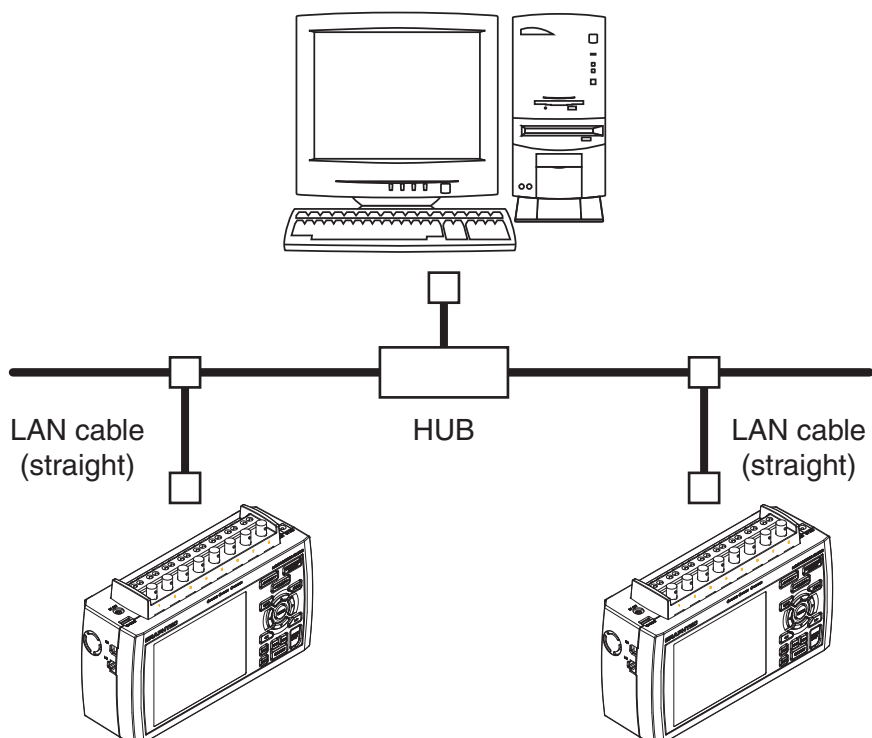

2.9 Using the Battery Pack (B-517: Option)

The B-517: option battery is the only battery type that can be used with the GL900.

Two battery packs need to be mounted when you have the GL900 run on batteries.

You can also mount only one battery pack when you charge it (using the AC power source). At this time, the battery pack can be mounted on either the right or left.

The running time using batteries is about 2.5 hours when the screen saver is operating.

Mounting the Battery Pack

- (1) While lightly pushing the grip of the battery cover, slid the cover in the direction indicated by the arrow.

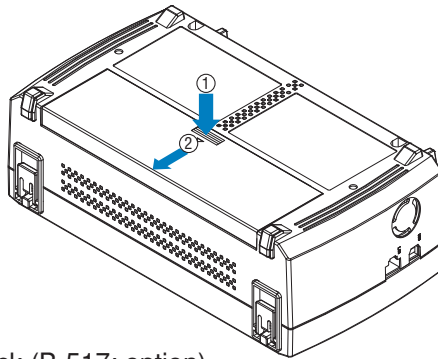

- (2) Attach the battery pack (B-517: option).

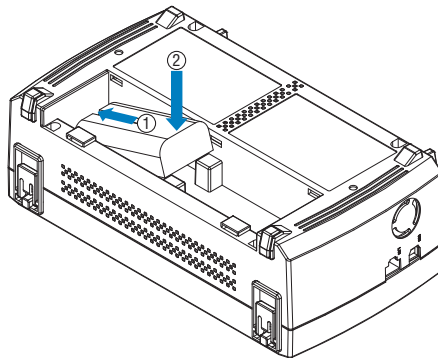

CAUTION

When you have the GL900 run on batteries, be sure to mount two battery packs with the same charge level.

Do not use a new battery with an old battery at the same time.

If you are not sure about the amount, charge each battery and then attach full-charged two battery packs.

- (3) Attach the battery cover.

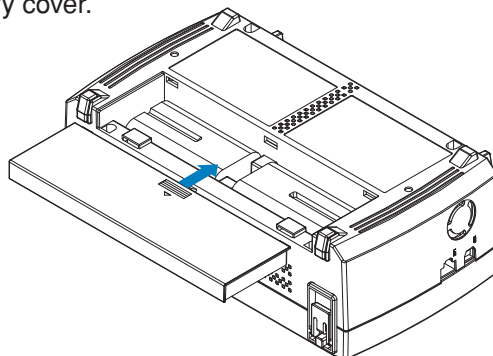

Charging the Battery

You can mount either one or two battery packs when you charge them.

Expected time required for charging:

- battery pack x 1: approx. 4 hours
- battery pack x 2: approx. 8 hours

The battery pack is charged by mounting it in the GL900, attaching AC adapter to the GL900.

- (1) Mount the battery pack in the GL900 (see the previous section for the mounting procedure).
- (2) Turn on the power to the GL900. (Please see Section 2.4, "Connecting the Power Cable and Turning on the Power").
- (3) The CHARGE LED lights.

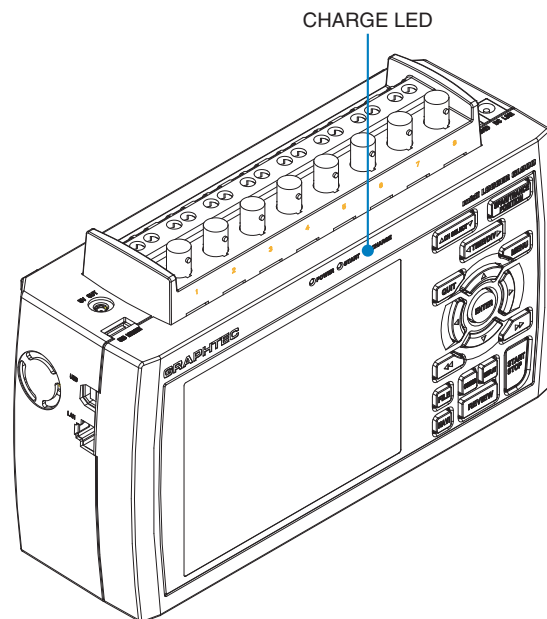

CHECKPOINT

- GL900 is equipped with a temperature monitor function which starts automatic charging as soon as it is cooled down. Therefore, depending on the internal temperature, charging may not be performed immediately.

When charging is attempted while the power is ON, charging may not be performed immediately depending on the temperature environment.

In such a case, set the Screen Saver settings to ON. GL900 will start charging as soon as it is cooled down.

Charging temperature: 15 to 35 °C

- If input is being made directly from the DC power supply instead of the AC adapter, the DC voltage must be at least approx. 16 V.
-

2.10 Connecting the Humidity Sensor (Option)

Connect the + and - lead wires of the humidity sensor (the B-530 option) to the desired terminals, and then insert the round connector into the 5V OUT connector on the GL900.

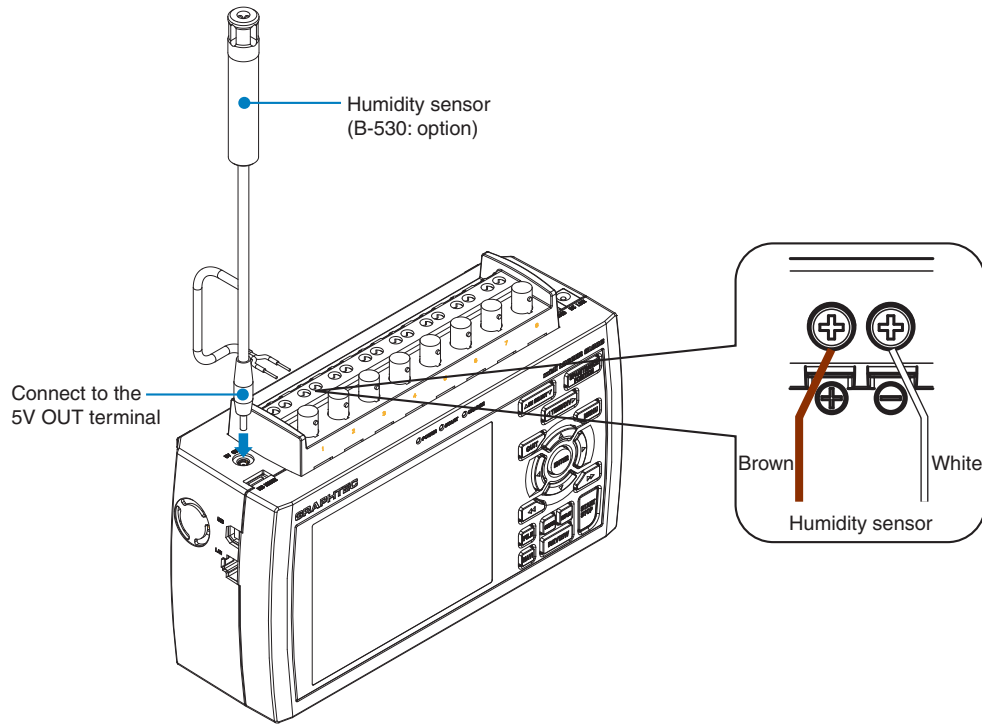

CAUTION

Do not use the sensor in a strong electrolyte environment. Measured results may not satisfy to the stated.

2.11 Precautions to Observe When Performing Measurement

Please be sure to read the following carefully in order to prevent electric shocks or shorts.

⚠ DANGER

- Do not apply voltage of 60 Vp-p or above between the analog input section and main unit (GND terminal), or between analog input channels.
- Be sure to use only the AC adapter provided as a standard accessory. The rated power supply range for the adapter is 100 to 240 VAC, and the rated frequency is 50/60 Hz. Do not use any other voltages.

Direct voltage input

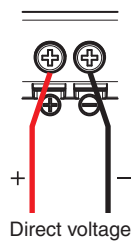

Thermocouple input

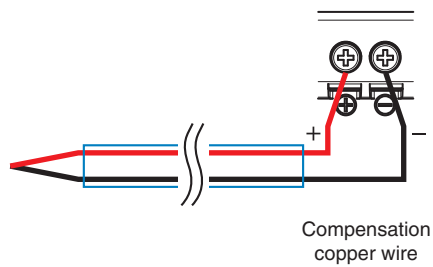

Direct current input

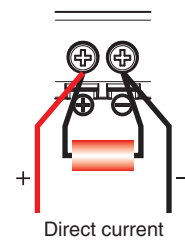

Shunt resistor
Example: If 4-20 mA is used, connect a 250 Ω ($\pm 0.1\%$) resistor and measure it in the 1-5 V range.

⚠ CAUTION

Make sure that the GL900 is not pulled by signal input cables when you connect them. The GL900 may fall down if it is pulled.

2.12 Noise Countermeasures

Be sure to connect the chassis GND of the object to be measured.

It may become effective by ensuring that the chassis GND wire of the measurement object is connected to a good ground.

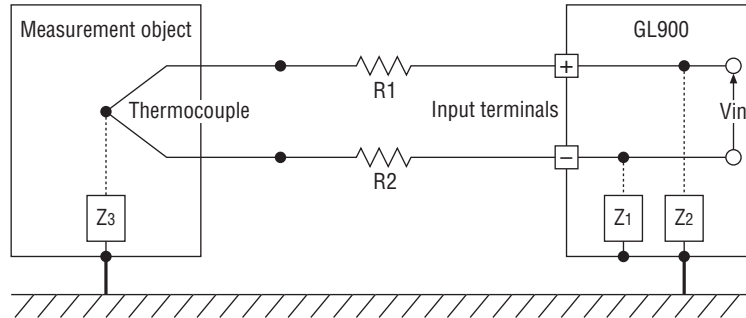

Connect the signal chassis GND and the measurement device chassis ground.

Use a short, thick lead to connect the chassis GND of the measurement object to the GL900's chassis GND. It will become even more effective if the ground potentials are the same.

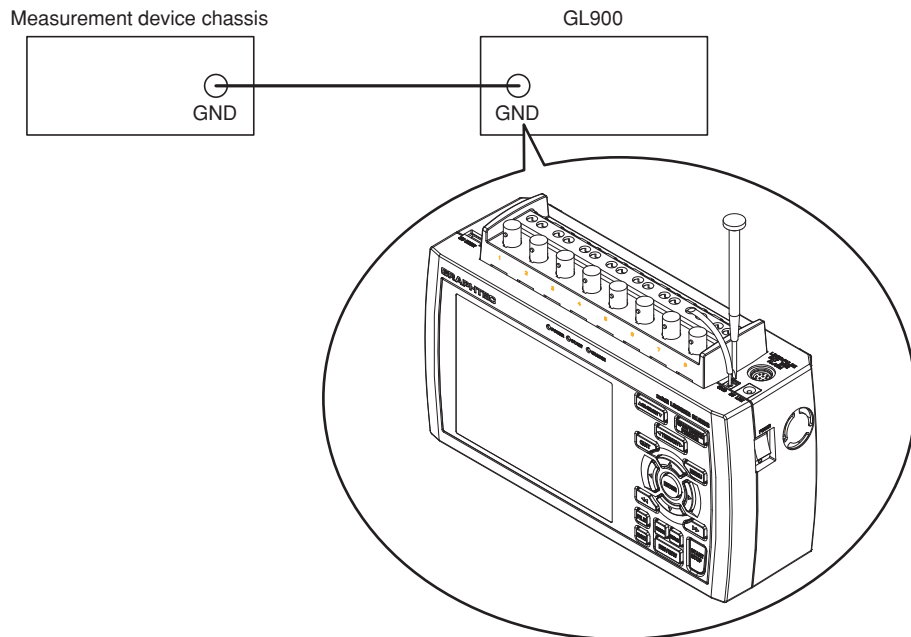

Examples of noise countermeasures

If measured values fluctuate due to external noise, the following countermeasures are recommended.

(Results may differ depending on the noise type.)

Example 1: Connect the GL900's GND to ground.

Example 2: Connect the GL900's GND to the measurement target's GND.

Example 3: In the AMP Settings menu, set Filter to any setting other than OFF.

2.13 Setting the Date and Time

If you are using the GL900 for the first time, charge the internal rechargeable battery and then make the date and time settings.

CAUTION

If the GL900 is not used for a period of approximately six months, the internal rechargeable battery may be discharged and the date and time may revert to the initial settings. If this happens, recharge the battery before using the GL900.

How to Recharge the Rechargeable Battery

Using the AC adapter provided, connect the GL900 to a mains power outlet, turn on the power switch, and then leave the GL900 connected for at least 24 hours.

How to Set the Date and Time

Press the [MENU] key, display the "OTHR" screen, and then set the date and time at the Date/Time Settings sub-menu. For details, see "Date/Time" on page 3-35.

CHAPTER 3

Settings and Measurement

This chapter describes the setting and measurement procedures for the GL800.

- 3.1 Window names and functions**
- 3.2 Key Operation**
- 3.3 Operation Modes**
- 3.4 Setting Menu**
- 3.5 WEB Server Function**

3.1 Window names and functions

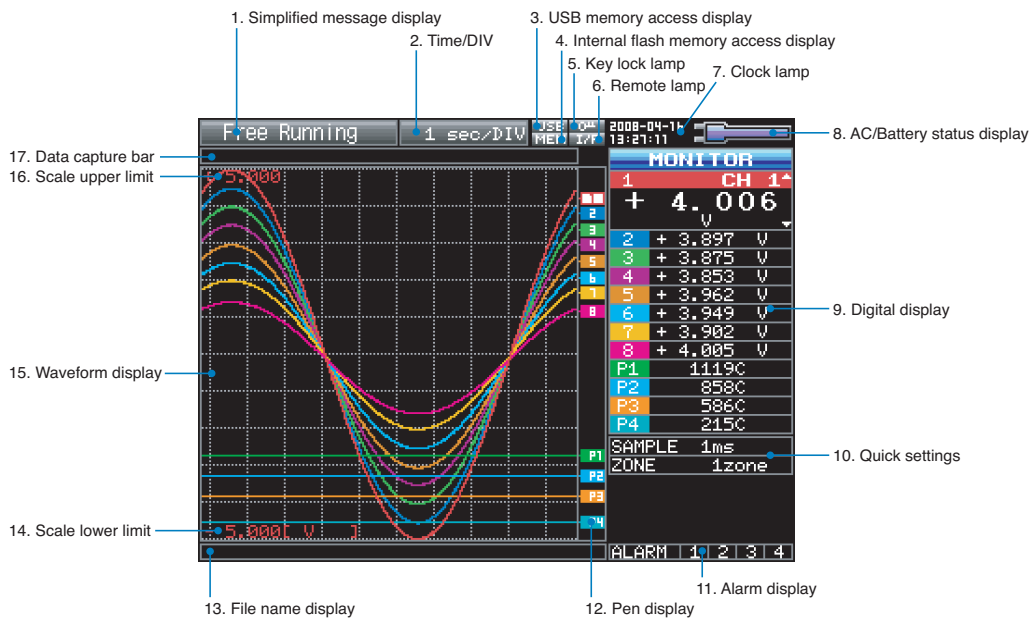

1. Simplified message display

Displays the system operation status.

Free Running	: Startup status or data is not being captured
Armed	: Waiting for generation of a trigger after measurement has started
Timer Hold	: Waiting for the time set on the timer
* Record/Replaying	: Capturing data and replaying captured data
* Rec to Int RAM	: Capturing data to the internal RAM of the GL900
* Rec to Int Mem	: Capturing data to the internal flash memory of the GL900
* Rec to USB Mem	: Capturing data to USB memory
* Auto Save...	: Auto-saving data (Data captured in the internal RAM is being saved to the internal flash memory or USB memory.)
Int RAM Replaying	: Replaying data in the internal RAM of the GL900
Int Mem Replaying	: Replaying data in the internal flash memory of the GL900
USB Mem Replaying	: Replaying data in USB memory
Repeat Waiting	: Waiting for the specified repeat time to elapse

* For details on data capture such as timer, trigger, and repeat, see page 3-27.

* For details on memory to be used for data capture, see page 3-24.



CAUTION

Do not turn off the power while the simplified message is "Capturing and Replaying", "Capturing to Internal RAM", "Capturing to Internal Flash Memory", "Capturing to USB Memory", or "Auto Saving" (those with an asterisk (*) in the above list). Otherwise, the captured data will be destroyed. Make sure that the message is completely gone (wait for 2 or 3 seconds) before turning off the power.

2. Time/DIV

Displays the current time scale.



3. USB memory access display

-  : No USB memory is inserted.
-  : USB memory is inserted but not being accessed.
-  : USB memory is being accessed. Do not remove the USB memory.

CAUTION

Do not remove the USB memory and/or turn OFF the device while the USB memory is being accessed. Failure to observe this caution may result in corrupted data and data loss.



4. Internal flash memory access display

-  : The internal flash memory is not being accessed.
-  : The internal flash memory is being accessed.



CAUTION

Do not turn OFF the device while the internal flash memory is being accessed. Failure to observe this caution may result in corrupted data and data loss.

5. Key lock display

-  : The keys are not locked. Normal operation is enabled.
 -  : All the keys are locked.
- For details on the key lock status, see page 3-46.

6. Remote display





-  : The GL900 is in local mode. The GL900 can be operated from itself.
-  : The GL900 is in remote mode.
The GL900 can be operated from a PC except for some operations.
To switch from remote mode back to local mode, clear the PC connection.
The GL900 will automatically return to local mode.
If the GL900 does not return to local mode, press the QUIT key.

7. Clock display

Displays the current date and time.

For details on the date and time settings, see page 3-35.

8. AC/Battery status display





-  : Running on the AC or DC power source.
-  : Running on the battery. The battery level is high.
-  : Running on the battery. The battery level is middle.
-  : Running on the battery. The battery level is low.
-  : Running on the battery. The battery is nearly out.

CAUTION

If the power is cut due to a power failure or a dead battery while data is being captured, the data being captured will be lost. Pay attention to the remaining battery level.

9. Digital display

Displays the input values for each channel. The SPAN/TRACE/POSITION key is used to change the display. The ∇ and \triangle keys or the CH SELECT key can be used to select the active channel (enlarged display). Moreover, the selected active channel is displayed at the very top of the waveform display.

	: Displays the input values. The input channels to be assigned can be changed using X-Y Display.
	: The span of the active channel can be changed using \triangleleft and \triangleright keys.
	: The position of the active channel can be changed using \triangleleft and \triangleright keys.
	: The display of the active channel can be turned ON and OFF using \triangleleft and \triangleright keys.

For details, see page 3-7.

10. Quick settings

Displays items that can be easily set. The ∇ and \triangle keys or the CH SELECT key can be used to make a Quick settings item active and the \triangleleft and \triangleright keys to change the values.

During Free Running in X-Y display, the pen can be moved up/down and the screen can be cleared.

* During data capture, the SAMPLE item cannot be changed.

11. Alarm display

Displays the alarm output terminal status.

Turns red if an alarm is generated. For the channel that generated the alarm, the input value in the digital display turns red.

12. Pen display

Displays the signal positions, trigger positions, and alarm ranges for each channel.

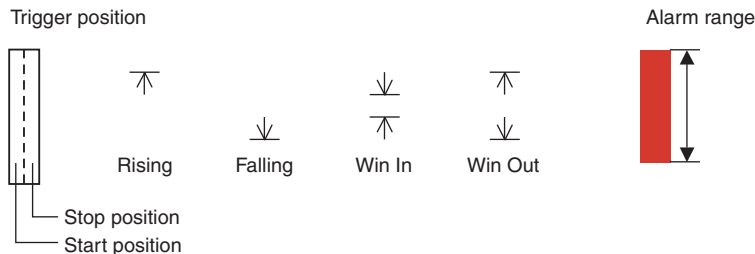

13. File name display

Displays the data capture file name during the data capture operation. If auto save is performed, the progress of data save is displayed with the bar in the background. Displays the data replay file name during the data replay operation.

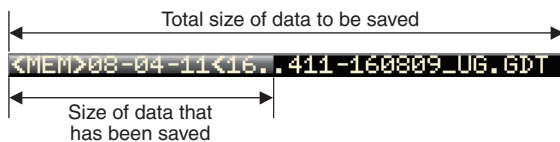

CAUTION

Do not turn off the power while the simplified message is "Capturing and Replaying", "Capturing to Internal RAM", "Capturing to Internal Flash Memory", "Capturing to USB Memory", or "Auto Saving." Otherwise, the captured data will be destroyed. Make sure that the message is completely gone (wait for 2 or 3 seconds) before turning off the power. See also "1. Simplified message display."

14. Scale lower limit

Displays the lower limit of the scale of the currently active channel.

15. Waveform display

Displays the waveform of the input signal.

16. Scale upper limit

Displays the upper limit of the scale of the currently active channel.

17. Data capture bar

(1) During data capture

Displays the elapsing time and the remaining capacity of the memory in use. The progress of data capture is displayed with the bar in the background.

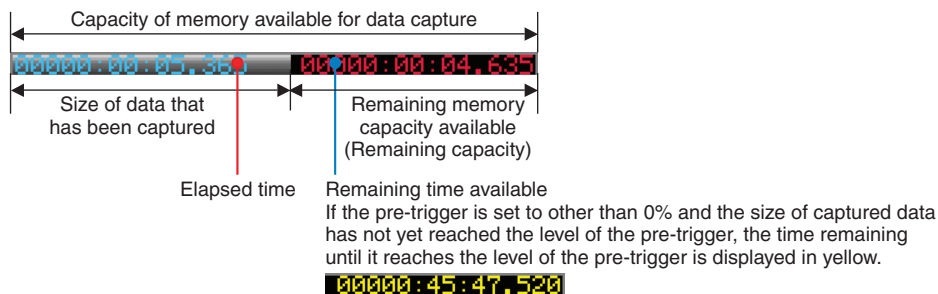

Capacity of memory available for data capture

Indicates the capacity of free memory available for data capture at the start of data capture. For example, if 128 MB of 256-MB memory is already in use, the remaining 128 MB is displayed.

If the data capture destination is the internal RAM, the specified time available for data capture (see page 3-26) is indicated.

* The maximum value is 2 GB per file. 2 GB is indicated if the capacity of free USB memory exceeds 2 GB.

Size of data that has been captured

Indicates how much of the above memory is currently in use for data capture.

Remaining memory capacity available

Indicates how much of the above memory remains available for data capture.

(2) During Data Replay

Indicates the displayed position, cursor position, and trigger position.

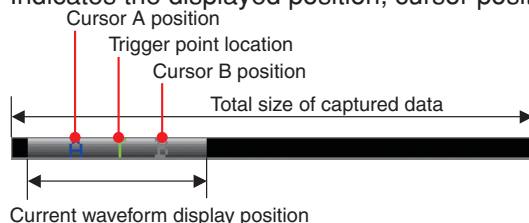

(3) Waiting for timer

Indicates the time at which the timer expires.



3.2 Key Operation

This section describes key operation.

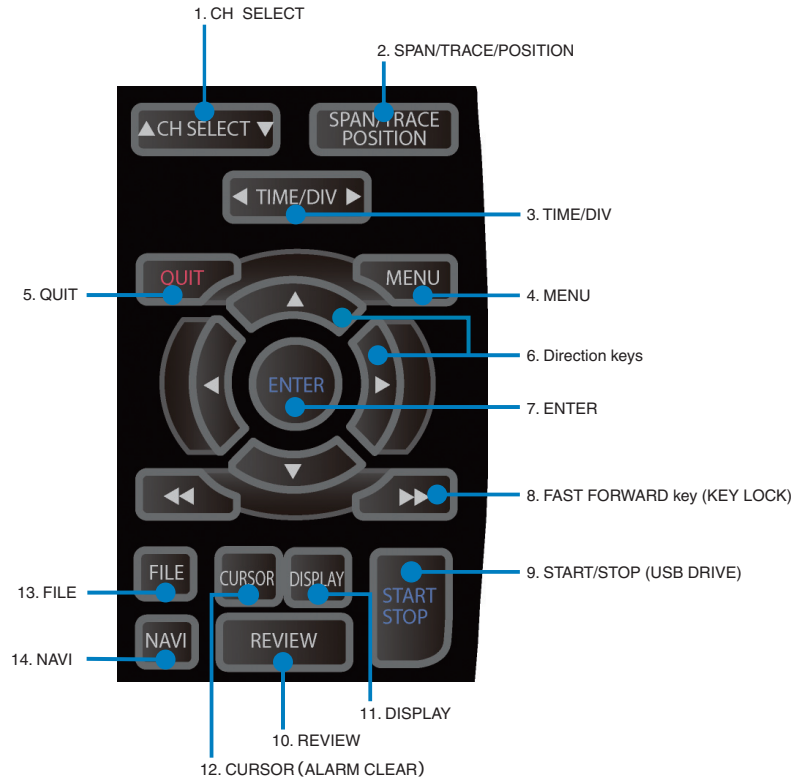

1. CH SELECT

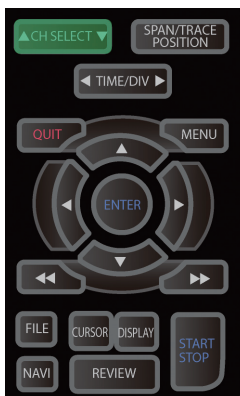

Press this switch to move the active channel in the Waveform + Digital or X-Y screen.

2. SPAN/TRACE/POSITION



Switches the display in the digital display.

Used to change the settings related to waveform display during Free Running (when stopped), data capture, and data replay.

Pressing this key will switch displays as shown below.

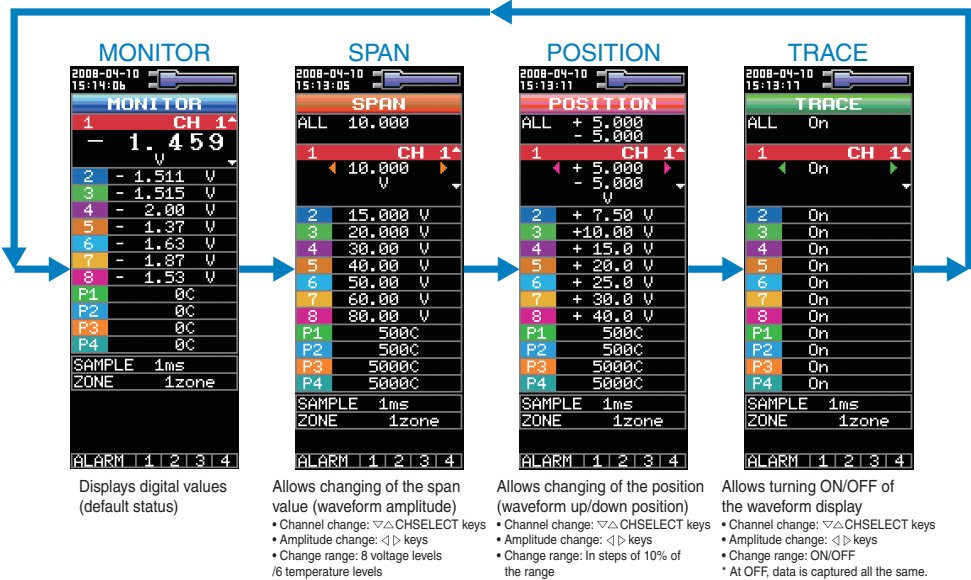

* When ALL is set, setting values for CH1 is reflected on other channels. When CH1 is OFF, ALL cannot be set.

3. TIME/DIV



Press the TIME/DIV key to change the time axis display range.



This key is inoperative in the X-Y screen.

4. MENU

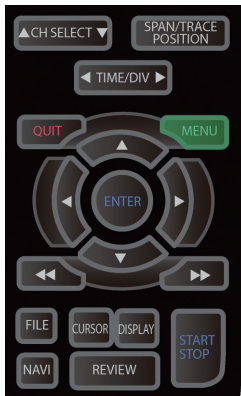

Open the settings window to capture data. For details on settings, see Section 3.4, "Setting Menus" on page 3-17.

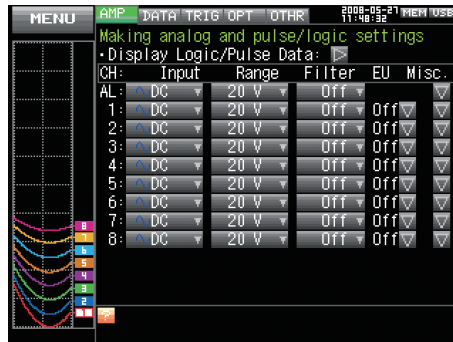

5. QUIT



The key is primarily used for the following operations.

- To cancel a setting during menu configuration.
- To return to the MONITOR window when the SPAN/TRACE/POSITION window is displayed.
- To cancel remote status (in which keys are disabled) through interface control.
- To close the menu screen.
- To quit data replay.
- To return from the Enlarged Waveform, Digital + Calculation Display, or X-Y screen to the Waveform + Digital screen.

6. Direction keys



These keys are primarily used for the following operations.

- To move in a menu or between setting items during menu configuration.
- To move the cursor during replay.
- To move the active channel in the Waveform + Digital screen or X-Y screen (Δ and ∇ keys).
- To change the setting of SPAN/TRACE/POSITION (\triangleleft and \triangleright keys).
- To change the quick settings (\triangleleft and \triangleright keys).
- To change the setting of the channel to be allocated in the X-Y screen (\triangleleft and \triangleright keys).

7. ENTER



This key is primarily used for the following operation:

- To finalize setting items during menu configuration or open submenus.

8. FAST FORWARD keys (KEY LOCK)

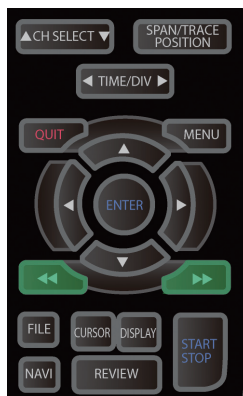

These keys are primarily used for the following operation.

- To move the cursor at high speed during replay.
- To change the operation mode in the file box.
- To set key lock (Hold down the left/right FAST FORWARD keys for at least two seconds. press again to unlock) A password for canceling the key lock can be specified.

For details, see page 3-46.

9. START/STOP (USB Drive Mode)



This key is used for the following two operations:

<Starting and stopping measurement>

- Starts capture during Free Running.
- Stops capture during capture.

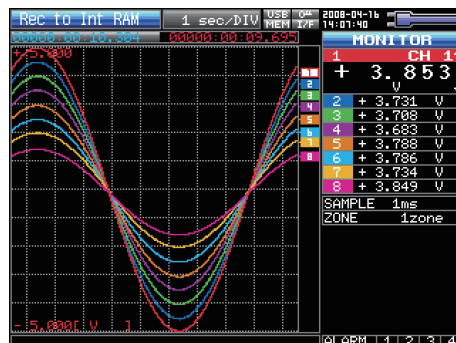

<USB Drive Mode>

In USB Drive Mode, the internal memory is recognized by the PC as external storage media.

With the internal memory recognized as a removable disk, files can be easily transferred, deleted, or otherwise manipulated on it.

- (1) Use a USB cable to connect the GL900 and a PC.
- (2) While pressing the GL900 START/STOP key, turn the power ON.
- (3) The external storage media is recognized by the PC and data exchange becomes possible.

* In USB Drive Mode, the display on the GL900 is as shown below.



CAUTION

- To cancel the USB Drive Mode, reboot the MT100.
- All operations, including data capture and replay, will be disabled during USB Drive Mode.

10. REVIEW



This key is used to replay captured data.

- During Free Running, replays the last captured data.

If no data has been captured yet because it is just after the power-on, no data is replayed (a message "No data captured" comes up).

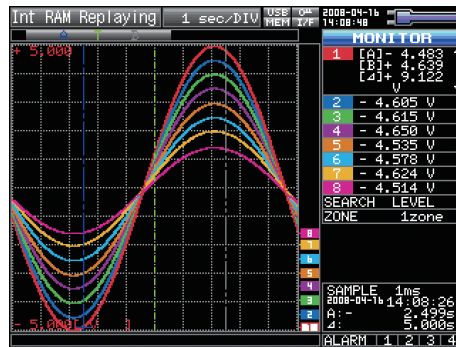

- * While capturing data, recently captured data is replayed (data capture is continued).

11. DISPLAY



This key is used to switch the window mode.

You can switch the window mode during Free Running (when stopped) and Capturing.

Pressing this key switches the window display as follows:

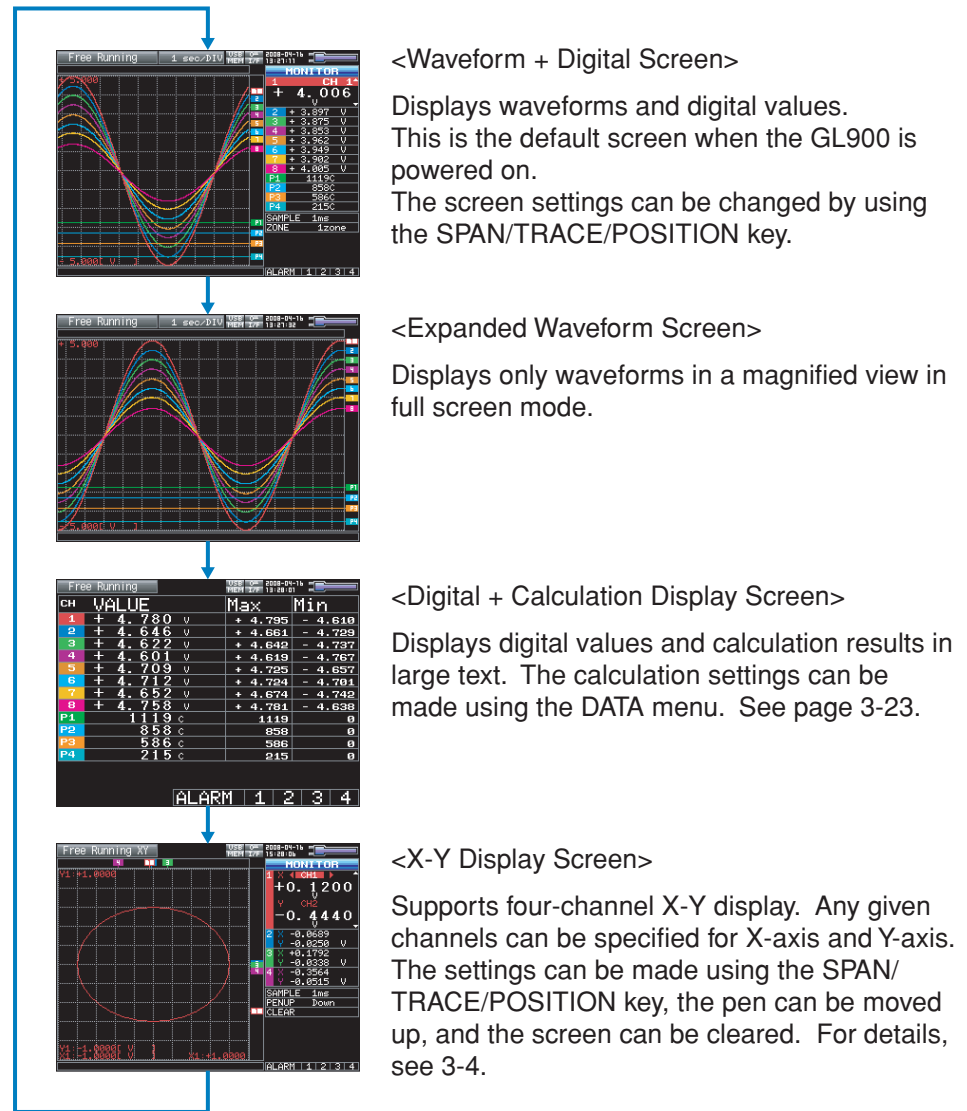

12. CURSOR(ALARM CLEAR)



This key has different roles in different operation statuses.

<When replaying captured data>

This key is used to toggle between cursors A and B during replay.

• Waveform + Digital Screen

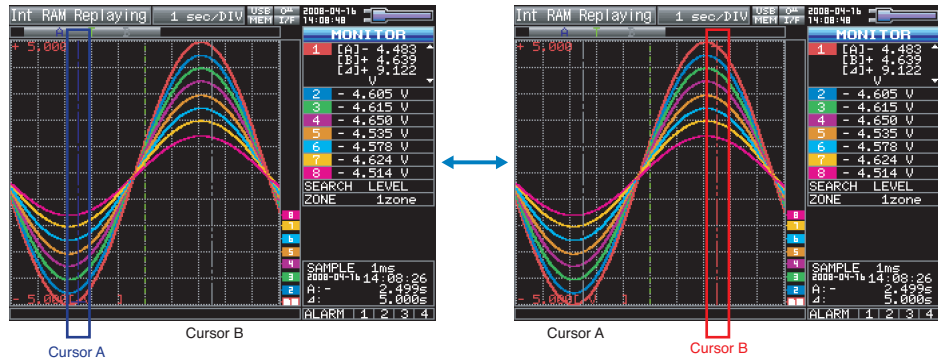

Cursor A is in blue when selected or in gray otherwise.

Cursor B is in red when selected or in gray otherwise.

The trigger point is indicated with a green line.

• X-Y Display Screen

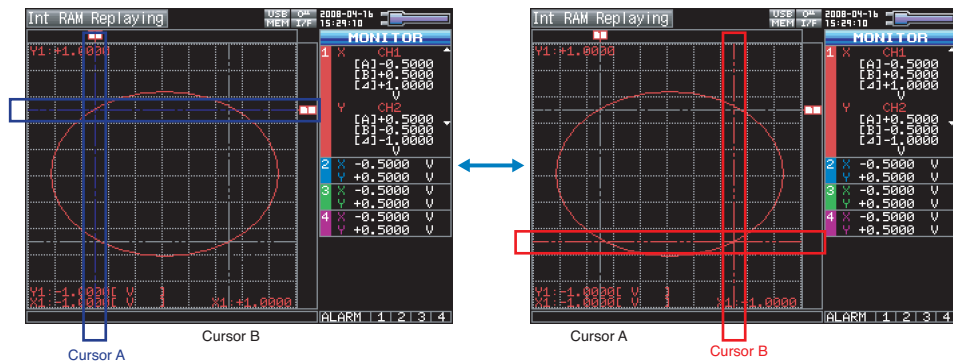

<When alarm generated>

When the alarm setting is "Hold generated Alarm", the maintained alarm is cleared.

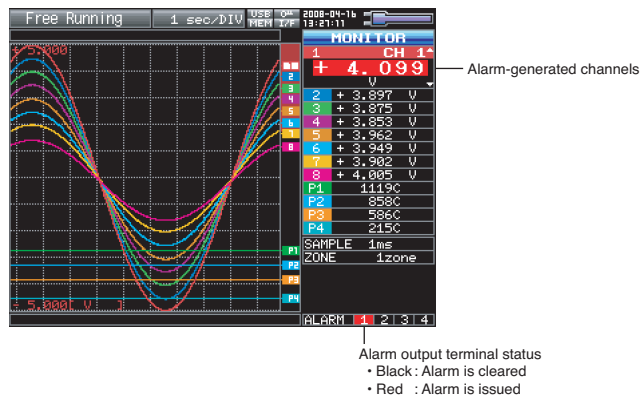

13. FILE



- Replays data in the internal flash memory and USB memory.
- This key is used for operations related to the internal flash memory and USB memory (such as copy and delete)
- Saves data in the internal RAM to the internal flash memory and USB memory.
- Copies the window.
- Saves the settings currently in use or loads settings.



14. NAVI



This key is used to display the key operation content during Free Running, capture, or replay.

During display of the NAVI screen, an explanation of how the key is used is displayed in the window.

To exit the NAVI screen, press the NAVI key again.

• Basic Procedures Used in Settings

The following are basic operation procedures for settings.



1. Press the MENU key to open each menu.
2. Use the $\nabla\Delta$ $\langle\rangle$ keys to move the cursor to the items you want to set.
3. Press the ENTER key to display a list of setting values.
4. Use the $\nabla\Delta$ $\langle\rangle$ keys to select a setting value.
5. Press the ENTER key to confirm the value.

The above operation is the basic procedure that may be used for each setting.

However, precise procedure may vary between setting items. Please follow the procedure indicated by each menu.

3.3 Operation Modes

You can check the system operation status in the simplified message display.

Operation	Operation	Operation
Free Running	Start up status or data is not being captured	Free Running
Capturing	Data is being captured in the main memory or USB device.	Capturing to Internal RAM, Capturing to Internal Flash Memory, Capturing to USB memory
Capturing and Replaying	Data being captured is being replayed	Capturing and Replaying
Replaying	Captured data is being replayed	Replaying from Internal RAM, Replaying from Internal Flash Memory, Replaying from USB Memory

Operation status transition

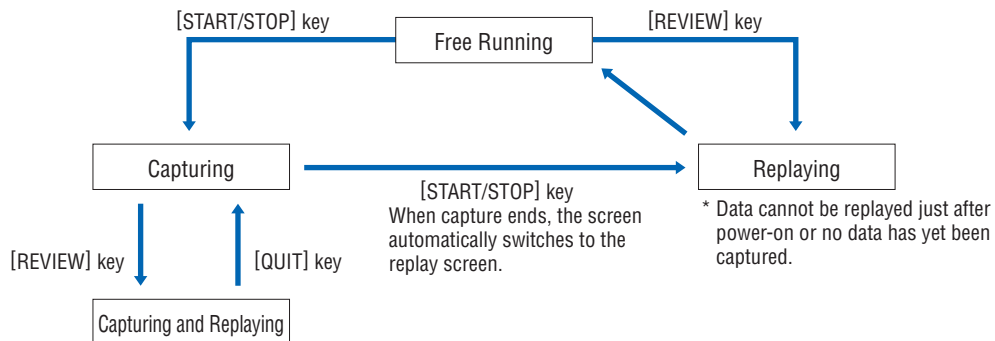

(1) Free Running

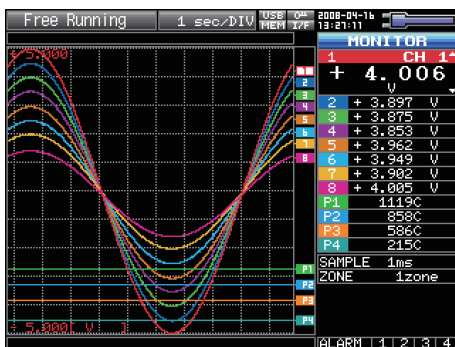

When in Free Running status, you primarily set up the system to capture data.

You can check the current input signal as a waveform or digital values.

Operations available during Free Running

Measurement parameters settings	The MENU key is used to change various setting items in configuration menus.
SPAN/TRACE/POSITION	The SPAN/TRACE/POSITION key is used to change settings.
Display mode	The DISPLAY key is used to change the display mode.
File operations	The FILE key is used to perform file-related operations.
Replay of last data (captured last time)	The REVIEW key is used to replay captured data.
Data replay	The FILE key is used to select data that you want to replay and replay it.

(2) Capturing

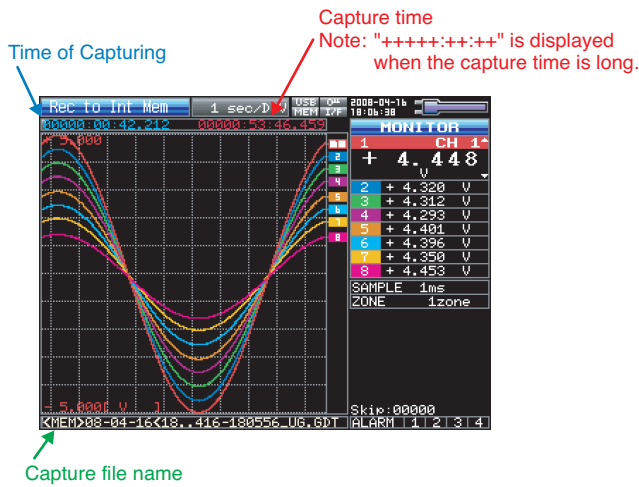

During data capture, data is captured into the Internal memory or USB device. You cannot use the MENU key to change the setting.

Operations available for change during capturing

SPAN/TRACE/POSITION	The SPAN/TRACE/POSITION key is used to change settings.
Display mode	The DISPLAY key is used to change the display mode.
Capturing and Replaying	The REVIEW key is used to replay captured data at the same time.

(3) Capturing and Replaying

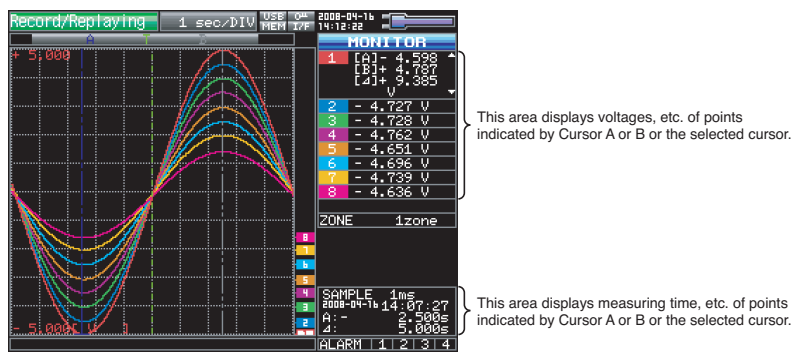

You can replay data during capture.

You can use the Direction keys (<|>) to move the cursor to captured data to check digital values.

Operations available during Capturing and Replaying

Moving cursor	The CURSOR key is used to switch between cursors A and B. The < > or << >> keys are used to move the cursors.
---------------	---

(4) Replaying

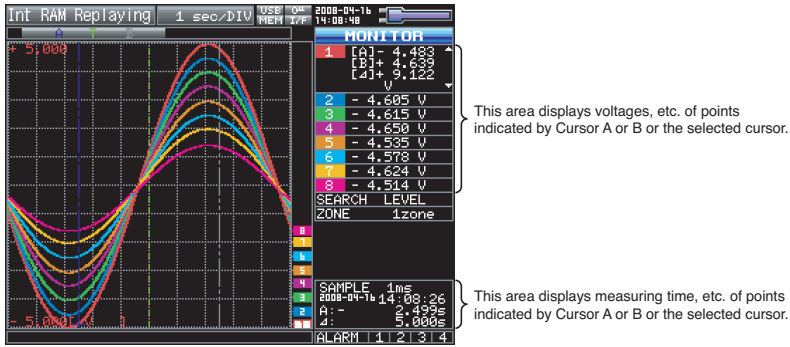

Displays captured data.

Available operation during replaying.

SPAN/TRACE/POSITION	The SPAN/TRACE/POSITION key is used to change settings.
Menu operations during data replay	The MENU key is used to move the cursor, search data and set calculation.
Moving cursors	The CURSOR key is used to switch between cursors A and B. The << or >> keys are used to move the cursors
File operations	The FILE key is used to save data in the internal RAM to the internal flash memory and USB memory.

3.4 Setting Menu

When you press the MENU key during Free Running, the following menu screens appear.

The menu screens are classified by the tab for each setting item.

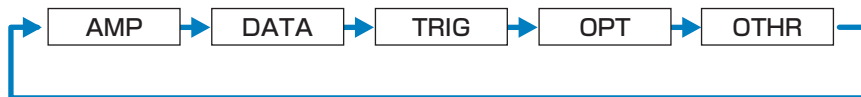

(1) AMP settings

This menu is used to specify input signal-related settings.

<Analog settings>

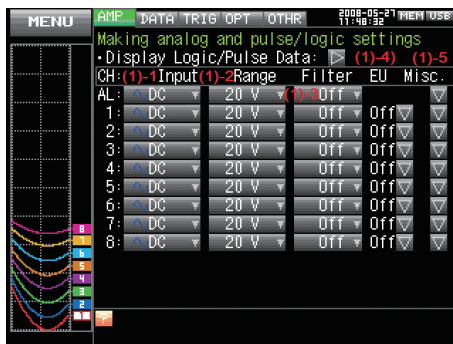

<Logic and Pulse settings>

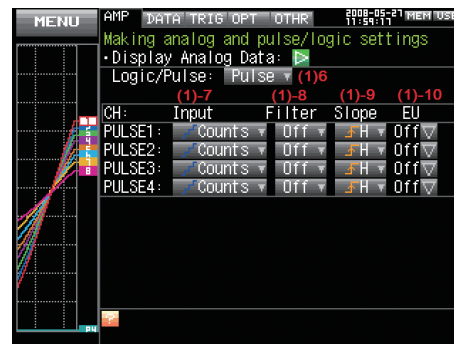

Setting		Selections available	
Input		Off, Voltage, Temperature, Humidity	
Range	[Voltage]	20, 50, 100, 200, 500 mV; 1, 2, 5, 10, 2	
	[Temperature]	TC-K, TC-J, TC-T, TC-R, TC-E, TC-B, TC-S	
Filter		Line, A5, 50, 500Hz	
EU (Scaling settings)	Function	Off, On	
	Measured value	Upper limit value	Numeric value input
		Lower limit value	Numeric value input
	EU output value	Upper limit value	Numeric value input
		Lower limit value	Numeric value input
	Decimal point	1, 10, 100, 1000, 10000	
	Unit selection	Current, length, area, volume, speed, acceleration, frequency, weight, power, pressure, flow, temperature	
Unit	(Selections vary depending on the selected units listed in the above.)		
Misc.	Span setting	Upper limit value	Numeric value input
		Lower limit value	Numeric value input
	Annotation setting	Text input (11 characters max.)	
	Perform Auto Zero ADJ.	Execute	
	Reset Auto Zero ADJ.	Execute	
Logic and Pulse		Off, Logic, Pulse	
	[Logic]	Off, On	
[Pulse]	Input	Off, Revolution counts, Counts, Inst.	
	Filter	Off, On	
	Slope	↑ H, ↓ L	
	EU	Function	Off, On
		Measured value	Numeric value input
		EU output value	Numeric value input
		Unit selection	Current, length, area, volume, speed, acceleration, frequency, weight, power, pressure, flow, temperature
		Unit	(Selections vary depending on the selected units listed in the above.)
		User-defined unit	Text input

[xxx] shows a case in which xxx is selected from available selections.

Switching displays

Analog and Logic/Pulse can be switched as shown below.

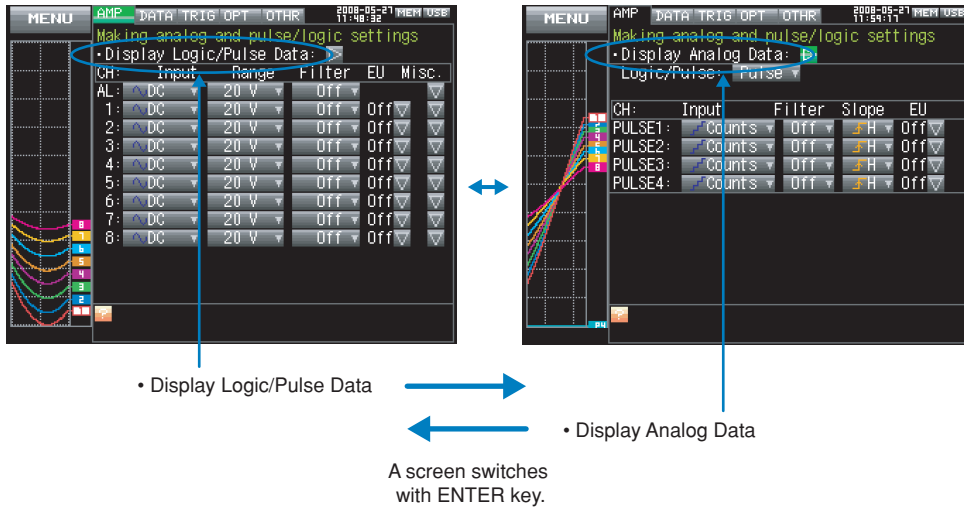

Analog settings

This screen allows you to set conditions for analog signals.



ALL and Span All Settings are set only for the currently displayed group (per 10 channels).

(1)-1 Input

Selects input conditions.

Selection	Description
Off	Disables the measurement of input signals and the waveform and digital display.
Voltage	Used for measuring direct-current voltages.
Temperature	Used for measuring temperatures.
Humidity	Used for measuring humidity with humidity sensor B-530. This selection sets the voltage range to 1V and disables EU settings.

(1)-2 Range

Specifies the range of signal input to be measured.

Input setting	Selection
Voltage	20, 50, 100, 200, 500mV; 1, 2, 5, 10, 20, 50, 100, 200, 500V; 1-5V
Temperature	TC-K, TC-J, TC-T, TC-R, TC-E, TC-B, TC-S, TC-N, TC-W,
Humidity	No selection

Available SPAN Settings

<Voltage Ranges>

Range	Maximum SPAN (measurement range)	Minimum SPAN	Minimum resolution
20mV	-22.000 to +22.000mV	0.200mV	0.001mV
50mV	-55.00 to +55.00mV	0.50mV	0.01mV
100mV	-110.00 to +110.00mV	1.00mV	0.01mV
200mV	-220.00 to +220.00mV	2.00mV	0.01mV
500mV	-550.0 to +550.0mV	5.0mV	0.1mV
1V	-1.1000 to +1.1000V	0.0100V	0.0001V
2V	-2.2000 to +2.2000V	0.0200V	0.0001V
5V	-5.500 to +5.500V	0.050V	0.001V
10V	-11.000 to +11.000V	0.100V	0.001V
20V	-22.000 to +22.000V	0.200V	0.001V
50V	-55.00 to +55.00V	0.50V	0.01V
100V	-110.00 to +110.00V	1.00V	0.01V
200V	-220.00 to +220.00V	2.00V	0.01V
500V	-550.0 to +550.0V	5.00V	0.1V
1-5V	-5.500 to +5.500V	0.050V	0.001V

<Temperature Ranges>

Range	Maximum SPAN	Minimum SPAN (p-p)	Measurement range	Minimum resolution
K	-270 to +2000°C	50°C	-200 to +1370°C	0.1°C
J	-270 to +2000°C	50°C	-200 to +1100°C	
T	-270 to +2000°C	50°C	-200 to +400°C	
R	-270 to +2000°C	50°C	0 to +1600°C	
E	-270 to +2000°C	50°C	-200 to +800°C	
B	-270 to +2000°C	50°C	+600 to +1820°C	
S	-270 to +2000°C	50°C	0 to +1760°C	
N	-270 to +2000°C	50°C	0 to +1300°C	
W	-270 to +2000°C	50°C	0 to +2000°C	

<Humidity Range>

Range	Maximum SPAN	Minimum SPAN (p-p)	Minimum resolution
	0 to +110%	1.0%	0.1%

(1)-3 Filter

Specifies the filter setting. Use the filter when there is noise in the input.

The filter is a low-pass filter.

Selection	Description
Off	The filter is disabled.
Line	The cutoff frequency is 1.5 Hz.
5Hz	The cutoff frequency is 5 Hz.
50Hz	The cutoff frequency is 50 Hz.
500Hz	The cutoff frequency is 500 Hz.

(1)-4 EU (Scaling)

Converts the measured signals to other units.

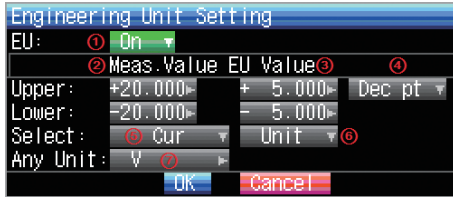

Setting	Description
(1) Function	Sets the function to ON or OFF.
(2) Meas. Value (Upper and Lower Limits)	Sets the upper and lower limits of the numeric value to be converted.
(3) EU Output Value (Upper and Lower Limits)	Sets the upper and lower limits of the output value after conversion.
(4) Dec pt	Specifies the decimal point position of the EU output value(s).
(5) Select	Selects the specific type of engineering units (The following selections are available). Current, length, area, volume, speed, acceleration, frequency, weight, power, pressure, flow, temperature
(6) Unit	Selects the converted unit. The units displayed in this item are those of the type selected in "Select." To set a unit not displayed in this item, define an arbitrary character string in "User-Defined Unit." The setting made in this item is displayed in "User-Defined Unit".
(7) User-Defined Unit	Selects the converted unit, which can be specified as a user-defined character string consisting of alphanumeric characters. (For details on text input, see page 3-41.) The settings made in "Select" and "Unit" are reflected here.

CHECKPOINT

- If a message appears, follow the instructions by reducing the number of digits to be output by one, or leaving the number of digits as is and changing the EU value.
- The Scaling operation is calculated using a ratio of the Meas. Value or EU Output Value settings. "++++/----" is displayed when the converted value cannot be processed by MT100. Span may be changed according to the value set for Scaling.

Setting Example

	Meas. Value	EU Value	Dec pt	Unit
Upper Value	+5.000	+20.00	+xx.xx	rpm
Lower Value	-5.000	-20.00		

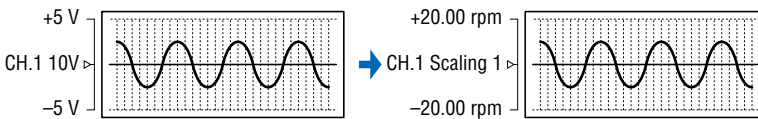

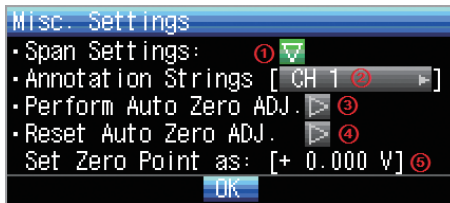
(1)-5 Misc.

Setting	Description
(1) Span	Sets the upper and lower limits of the span in which waveforms should be displayed.
(2) Annotation	Sets an annotation (comment) to be displayed for each channel. The annotation can be 11 characters long at the maximum. You can use alphanumeric and kana characters and symbols. (For details on text input, see page 3-41.)
(3) Perform Auto Zero ADJ	Performs calculation using the current input voltage as the zero position voltage value.
(4) Reset Auto Zero ADJ	Cancels the zero position voltage value and displays the input voltage.
(5) [Zero Position Voltage Value]	Displays the zero position voltage value (display only).

Logic and Pulse settings

Specifies the digital input settings.

(1)-6 Logic/Pulse

Selects the digital input processing method.

Setting	Description
Off	Disables the measurement of digital input.
Logic	Digital input is processed as logic signals.
Pulse	Digital input is processed as pulse signals.

(1)-7 Input

Sets the pulse measurement mode. This item can be set only when Pulse is selected in (1)-6.

Setting	Description
Off	Disables the pulse input.
Revol.	Counts the number of pulses per second and multiplies it by 60 to capture an rpm value.
Counts	Captures the cumulative number of pulses for each sampling interval from the start of measurement.
Inst.	Captures the number of pulses for each sampling interval.

(1)-8 Filter

Sets the filter for digital input.

Setting	Description
Off	Disables the hardware filter.
On	Enables the hardware filter. The filter is effective in an environment where there is lots of noise. Filter is approximately 30 Hz (-3dB).

(1)-9 Slope

Sets the slope (direction) to count the number of pulses. This item can be set only when Pulse is selected in (1)-6.

Setting	Description
↑ H	Counts the rising edges of pulses.
↓ L	Counts the falling edges of pulses.

(1)-10 EU (Scaling)

Converts the measured signals to other units.

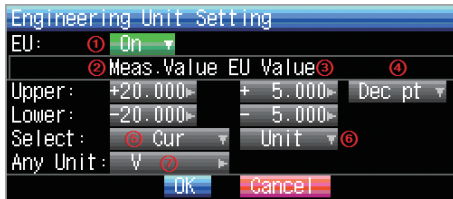

Setting	Description
(1) Function	Sets On/Off of the Scaling function.
(2) Meas. Value (Upper and Lower Limits)	Sets the upper and lower limits of the numeric value to be converted.
(3) EU Output Value (Upper and Lower Limits)	Sets the upper and lower limits of the output value after conversion.
(4) Dec pt	Specifies the decimal point position of the EU output value(s).
(5) Select	Selects the specific type of engineering units (The following selections are available). Current, length, area, volume, speed, acceleration, frequency, weight, power, pressure, flow, temperature
(6) Unit	Selects the converted unit. The units displayed in this item are those of the type selected in "Select." To set a unit not displayed in this item, define an arbitrary character string in "User-Defined Unit." The setting made in this item is displayed in "User-Defined Unit"
(7) User-Defined Unit	Selects the converted unit, which can be specified as a user-defined character string consisting of alphanumeric characters. (For details on text input, see page 3-41.) The settings made in "Select" and "Unit" are reflected here.

CHECKPOINT

- If a message appears, follow the instructions by reducing the number of digits to be output by one, or leaving the number of digits as is and changing the EU value.
- The Scaling operation is calculated using a ratio of the Meas. Value or EU Output Value settings. "++++/----" is displayed when the converted value cannot be processed by MT100. Span may be changed according to the value set for Scaling.

Setting Example

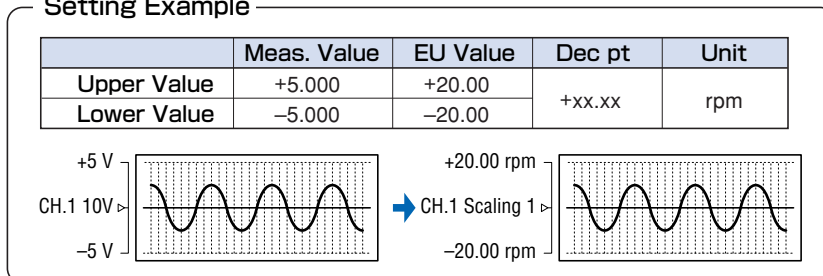

(2) DATA settings

This menu is used to specify setting items related to capture and calculations.

<Capturing data to the internal RAM>

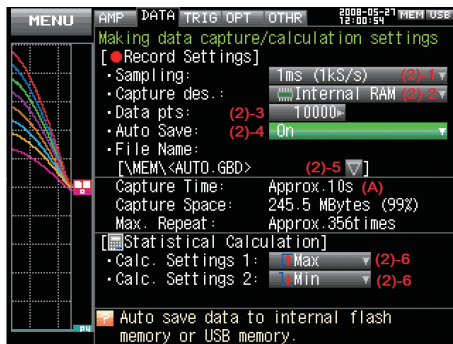

<Capturing data to the internal flash memory or USB memory>



Setting	Selection
Sampling Interval	10, 20, 50, 100, 200, 500 us; 1, 2, 5, 10, 20, 5
Data capture destination	Internal RAM, Internal Flash Memory, USB Memory
[Internal RAM] Number of capture points	1000 to 1000000
Auto Save	Off, On
[On] File Name	* See the following section on the data capture
[Internal Flash Memory] File Name	* See the following section on the data capture
or	
[USB Memory]	
Function 1	Off, Average, Max, Min, Peak, RMS
Function 2	Off, Average, Max, Min, Peak, RMS

[xxx] shows a case in which xxx is selected from available selections.

Data capture file name

Setting	Selection
Folder (File)	Destination : MEM, USB1 Folder : Text input (if it is automatically named) File : Text input (if it is user-defined)
Name Type	Auto or User
File Format	Binary (GBD), Text (CSV)

(2)-1 Sampling Interval

Specifies intervals used to capture data.

Capture destination	Selections available
Internal RAM	10, 20, 50, 100, 200, 500us; 1, 2, 5, 10, 20, 50, 100, 200, 500ms; 1, 2, 5, 10, 20, 30s; 1min
Internal flash memory	1, 2, 5, 10, 20, 50, 100, 200, 500ms; 1, 2, 5, 10, 20, 30s; 1min
USB memory	1, 2, 5, 10, 20, 50, 100, 200, 500ms; 1, 2, 5, 10, 20, 30s; 1min

(2)-2 Data Capture Destination

Specifies the data capture destination for captured data.

Selection	Description
Internal RAM	<p>Captures the measured data to the internal RAM. The data will be lost when the power is turned off. The data will be overwritten when next data is captured. Check the waveform and, if it is OK, press the File key to save the data (see page 3-36). If Auto Save is set to On, data will be automatically saved. See Section (2)-4.</p> <p>Tip This selection can be used for any sampling interval. Specify this selection if you want to capture data at higher rates than 500 us. This selection comes in handy for saving the memory space if you check the waveform of captured data first and save only necessary data.</p>
Internal flash memory	<p>Captures the measured data to the internal flash memory. The data once captured is retained even after the power is turned off. This selection cannot be specified if the sampling interval is from 10 to 500 us. Select a sampling interval lower than 1 ms.</p>
USB memory	<p>Captures the measured data to the internal flash memory. The data once captured is retained even after the power is turned off. This selection cannot be specified if the sampling interval is from 10 to 500 us. Select a sampling interval lower than 1 ms.</p> <p>Tip Large-capacity USB memory can also be used. The use of USB memory comes in handy when you want to capture data many times or the capacity of the internal flash memory is not sufficient for long measurement (Data up to 2 GB can be captured per data capture). * Note that you cannot use USB memory with a security function such as fingerprint authentication.</p>

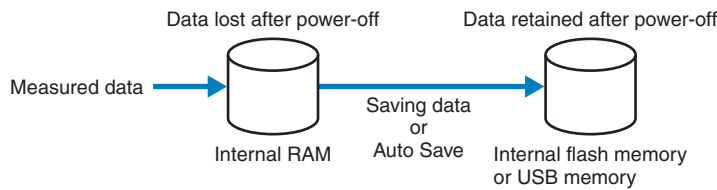

(2)-3 Number of Capture Points

Specifies the number of data points to be captured to the internal RAM. This item can be set only when Internal RAM is selected in (2)-2.

Before setting this item, check the time available for data capture ((A) in the figure).

(2)-4 Auto Save

Specifies whether to automatically save data captured to the internal RAM. This item can be set only when Internal RAM is selected in (2)-2.

Selection	Description
Off	<p>Disables auto save of data. Data captured to the internal RAM is lost when the power is turned off or next data is captured. If you want to keep data, press the FILE key to save the data.</p>
On	<p>Enables auto save of data. Data captured to the internal RAM is saved either to the internal flash memory or USB memory.</p>



Changing the sampling interval, capture destination, or number of capture points will change the screen display of the time available for data capture, capacity available for data capture, and possible number of times of repeating. If you find that the measuring time exceeds the capacity available for data capture, either change the sampling interval or capture destination (to large-capacity USB memory).

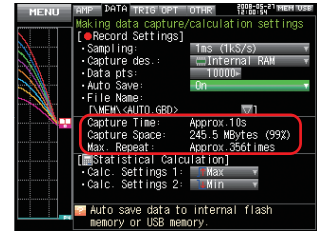

Time available for data capture Indicates how long data can be captured.

Capacity available for data capture Indicates the capacity available for data capture with the memory size if the data capture destination is the internal flash memory or USB memory. The figure shown in brackets is the percentage of free memory space to the total memory size.

Possible number of times of repeating Indicates how many times data captured to the internal RAM can be saved to the save destination device if Auto Save is set to On. Beware of using this setting particularly when Repeated Capturing is set to On for the trigger (For details, see page 3-26 in the "TRIG Settings.")

(2)-6 Statistical Calculation Settings

The GL900 can perform two statistical calculations.

This section describes specifying the statistical calculation settings.

Selection	Description
Off	Calculation is not performed.
Average	Displays the simple average value of data being captured.
Max	Displays the maximum value of data being captured.
Min	Displays the minimum value of data being captured.
Peak	Displays the peak value of data being captured.
RMS	Displays the effective value of data being captured. The calculation formula is as shown below. $R.M.S = \sqrt{\sum D^2/n}$ * D : data n : number of data



- Operation results are displayed in the Digital + Calculation Display screen.
- Calculation will start upon power ON. Pressing the Start key to begin measurement will clear the calculation.

(3) TRIG Settings

This menu is used to specify trigger conditions and alarm settings.

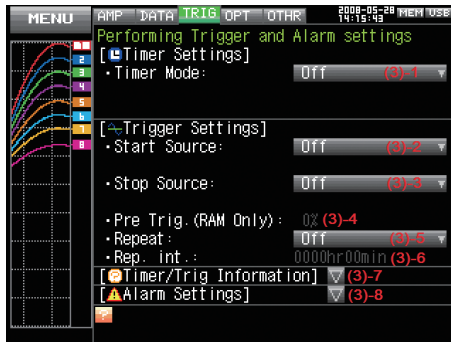

Setting		Selections available
Timer mode		Off, Date and Time, Every Day Cycle, Every Hour Cycle
	[Date and Time]	Start side source setting Date: January 1, 2005 to December 31, 2035 Time: 00:00 to 23:59 (Hour:Minute)
		Stop side source setting Date: January 1, 2005 to December 31, 2035 Time: 00:00 to 23:59 (Hour:Minute)
	[Every Day Cycle]	Start side source setting Time: 00:00 to 23:59 (Hour:Minute)
		Stop side source setting Time: 00:00 to 23:59 (Hour:Minute)
	[Every Hour Cycle]	Start side source setting Time: 00:00 to 59:59 (Minute:Second)
		Stop side source setting Time: 00:00 to 59:59 (Minute:Second)
Start side source setting		Off, Level, External Input
	[Level]	Combination Level OR, Level AND, Edge OR, Edge AND
		Mode Analog : Off, ↑ H, ↓ L, Win In, Win Logic : Off, ↑ H, ↓ L Pulse : Off, ↑ H, ↓ L
		Level Numeric value setting
Stop side source setting		Off, Level, External Input, Time
	[Level]	Combination Level OR, Level AND, Edge OR, Edge AND
		Mode Analog : Off, ↑ H, ↓ L, Win In, Win Logic : Off, ↑ H, ↓ L Pulse : Off, ↑ H, ↓ L
		Level Numeric value setting
	[Time]	0000:00:01 to 9999:59:59 (Hour:Minute:Second)
Pre-trigger		0, 10, 20, 30, 40, 50, 60, 70, 80, 90, 100%
Repeated capturing		Off, On
Repeat interval		0000:00 to 9999:59 (Hour:Minute)
Timer trigger information		▽ Display Information
Alarm level settings	Alarm Hold	On, Off
	Mode	Analog : Off, ↑ H, ↓ L, Win In, Win Out Logic : Off, ↑ H, ↓ L Pulse : Off, ↑ H, ↓ L, Win In, Win Out
	Level	Numeric value setting
	Output	1, 2, 3, 4

[xxx] shows a case in which xxx is selected from available selections.

(3)-1 Timer Mode

Sets the timer function.

When the timer function is used (set to a selection other than OFF), data capture is enabled only during the time for which the timer is set.

Selection	Description
Off	The timer function is not used. Data capture starts according to triggers.
Date and Time	Data capture starts when a trigger is generated only during certain (specified) date and time. ⇒ When Date and Time is selected, set the date and time both on the start and stop sides.
Every Day Cycle	Data capture starts when a trigger is generated only during the same (specified) time every day. ⇒ When Every Day Cycle is selected, set the time (hour and minute) both on the start and stop sides.
Every hour cycle	Data capture starts when a trigger is generated only during the same (specified) time every hour. ⇒ Set the time (minute and second) both on the start and stop sides.

The actual timing conditions for data capture are related to triggers. See also Sections (3)-2, (3)-3, and (3)-7.

(3)-2 Start Side Source Settings

Specifies trigger conditions to start data capture.

Selection	Description
Off	Starts capturing data unconditionally (when the Start/Stop key is pressed or the time specified for the timer function arrives).
Level	Starts capturing data when a specified level condition is met. ⇒ When Level is selected, set the condition for each channel. See page 3-30.
External Input	Starts capturing data when an input signal is received from an external trigger terminal. * A trigger is generated when the voltage changes from 5V (open) to 0V (short circuit to GND).

The actual timing conditions for data capture are related to the timer. See also Sections (3)-1, (3)-3, and (3)-7.

(3)-3 Stop Side Source Settings

Specifies trigger conditions to stop data capture.

Selection	Description
Off	Stops capturing data unconditionally (when the Start/Stop key is pressed or the time specified for the timer function arrives).
Level	Stops capturing data when a specified level condition is met. ⇒ When Level is selected, set the condition for each channel. See page 3-30.
External Input	Stops capturing data when an input signal is received from an external trigger terminal. * A trigger is generated when the voltage changes from 5V (open) to 0V (short circuit to GND).
Time	Stops capturing data after a specified length of time elapses after starting data capture. ⇒ When Time is selected, set the time after which you want to stop capturing data.

The actual timing conditions for data capture are related to the timer. See also Sections (3)-1, (3)-2, and (3)-7.

(3)-4 Pre-trigger

Specifies the percentage of data to be captured before a trigger is generated.

* Pre-trigger can be selected only when the data capture destination is the internal RAM and the start side source setting is other than OFF.

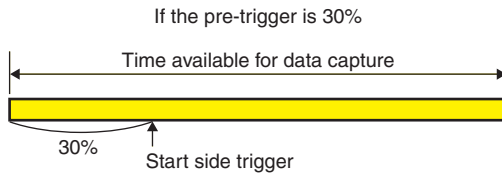

(3)-5 Repeated Capturing

Sets the repeat function for repeated capturing.

Selection	Description
Off	The repeat function is not used.
On	The repeat function is used. After one data capture process ends, the next data capture process starts (or a trigger is waited for if the start side source setting is other than Off).

(3)-6 Repeat Interval

Specifies the interval from the start of one data capture process to the start of another data capture process if the repeat function is used.

(3)-7 Timer Trigger Information

Displays the timer and trigger information in an easy-to-understand manner.

Example

Timer Mode : Every Day Cycle
 Start Side Source Setting : Level
 Stop Side Source Setting : Time
 Repeated Capturing : On

Data capture is enabled only in this interval.
 Data is actually captured in this interval.

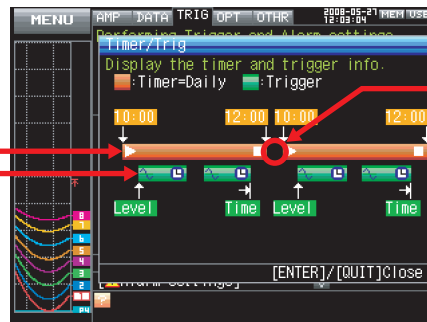

A trigger generated in this interval will not start data capture.

* This is only a conceptual illustration in which the graph length, number of times of repetition, and other items do not agree with the actual time.

(3)-8 Alarm Setting

Specifies alarm generation conditions and output destinations. When the conditions specified here are met, an alarm is output from the alarm output terminal (specify the output destination number for each channel).

With "Hold Generated Alarm" set to "Hold", the alarm status is maintained after the conditions are met once even if they do not continue to be met (Press the CURSOR key to clear the alarm).

See the next page for the condition setting for each channel.

Trigger Level Settings/Alarm Level Settings

If the start side source setting or stop side source setting is "Level", specify detailed conditions for each channel.

The overall structure of level triggers are as shown below.

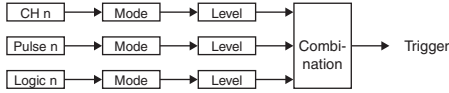

* Pulse and Logic are toggled back and forth.

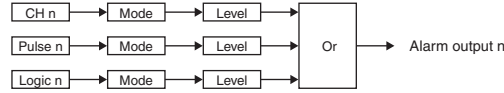

* Pulse and Logic are toggled back and forth.

* Specify an alarm output destination for Pulse and Logic for each channel. The conditions are ORed for each alarm output destination.

Example) Suppose CH1 and CH2 are set to Output 1 and CH3 and CH4 to Output 2.
If either CH1 or CH2 meets the conditions, Alarm Output 1 occurs.
If either CH3 or CH4 meets the conditions, Alarm Output 2 occurs.

<Trigger Level Settings>



<Alarm Settings>



Setting	Description
(1) Combination	<p>Sets the combination of trigger conditions set for each channel.</p> <p>Level OR : Starts (stops) capturing data when at least one trigger condition is met. Each condition is a level operation.</p> <p>Level AND : Starts (stops) capturing data when all trigger conditions are met. Each condition is a level operation.</p> <p>Edge OR : Starts (stops) capturing data when at least one trigger condition is met. Each condition is an edge operation.</p> <p>Edge AND : Starts (stops) capturing data when all trigger conditions are met. Each condition is an edge operation.</p>
(2) Mode	<p>Specifies the mode for trigger comparison for each channel.</p> <p>Off : Disables triggers for the set channel.</p> <p>↑ H (Rising) : Generates a trigger when an input signal is above the specified level.</p> <p>↓ L (Falling) : Generates a trigger when an input signal is below the specified level.</p> <p>Win In : Generates a trigger when an input signal is (has come) between the upper and lower limit levels set for each channel. * There is no setting for a logic channel.</p> <p>Win Out : Generates a trigger when an input signal is not (has moved out from) between the upper and lower limit levels set for each channel. * There is no setting for a logic channel.</p>
(3) Level	<p>Specifies the level for trigger comparison.</p> <p>Set one level for comparison if the mode is set to ↑ H (Rising) or ↓ L (Falling).</p> <p>Set two levels for comparison if the mode is set to Win In or Win Out.</p>
(4) Hold Generated Alarm	<p>Specifies the operation that occurs when the alarm conditions are met once and then are no longer met.</p> <p>Hold : Maintains the alarm status when the alarm conditions are met once and then are no longer met. (Press the CURSOR key to clear the alarm).</p> <p>Do Not Hold : Clears the alarm status when the alarm conditions are met once and then are no longer met.</p>

About Level and Edge Operations

In the level operation, the trigger conditions are assumed to be met only if they are met when the START key is pressed (after the timer reaches the set time).

In the edge operation, the trigger conditions are assumed NOT to be met even if they are met when the START key is pressed (after the timer reaches the set time).

The trigger conditions are assumed to be met only if they are no longer met and then are met again.

Example) If the mode is Rising

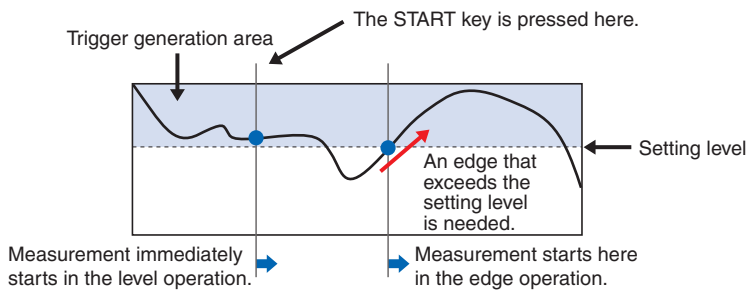

About the Trigger and Alarm Operations

H : A trigger/alarm is generated when the signal input rises to (or exceeds) the specified level.

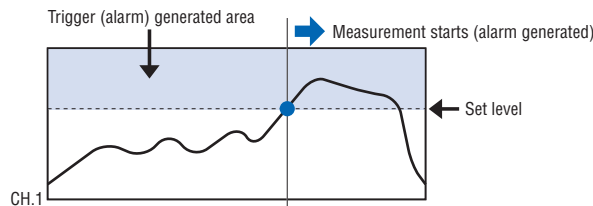

L : A trigger/alarm is generated when the signal input falls to (or falls below) the specified level.

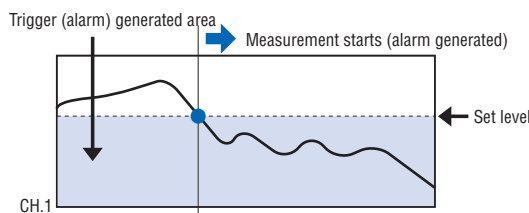

Win In : Used to specify the upper and lower limits for each channel. When the signal level goes within (or is within) either limit, a trigger/alarm is generated.

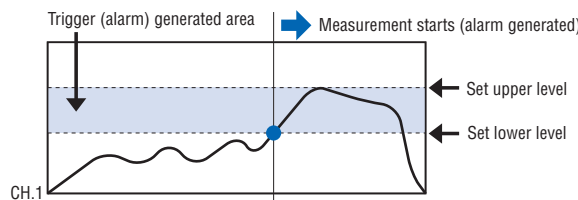

Win Out : Used to specify the upper and lower limits for each channel. When the signal level goes outside (or is outside) either limit, a trigger/alarm is generated.

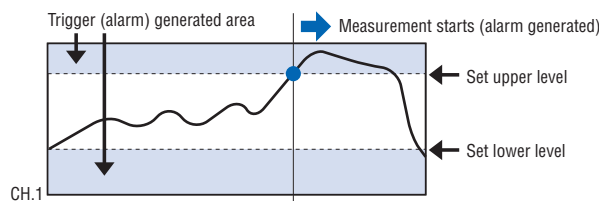

(4) OPT Settings

This menu is used to specify conditions for PC connection and USER settings for switching between users.

The USER settings allow you to read out the stored setting conditions easily by switching between users.

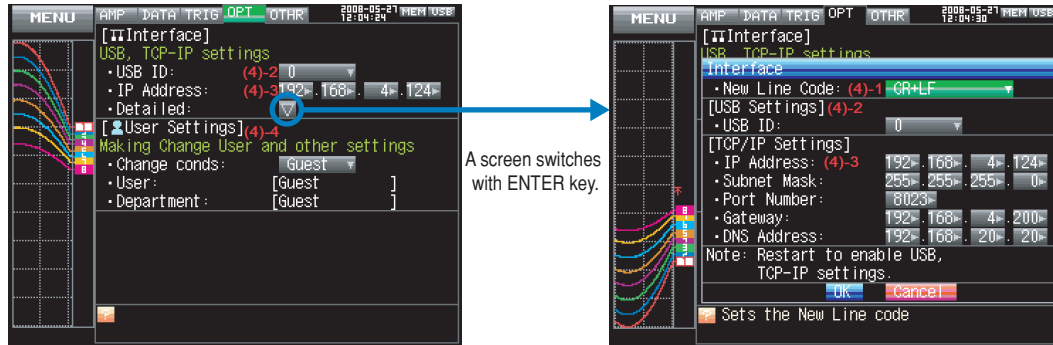

Setting	Selections available	
USB ID	0 to 9	
IP Address	0 to 255. 0 to 255. 0 to 255. 0 to 255	
Detailed Settings	New Line Code	CR+LF, LF, CR
	USB ID	0 to 9
	IP Address	0 to 255. 0 to 255. 0 to 255. 0 to 255
	Subnet Mask	0 to 255. 0 to 255. 0 to 255. 0 to 255
	Port Number	1024 to 65535
	DNS Address	0 to 255. 0 to 255. 0 to 255. 0 to 255
Setting Condition Switching	Guest, User 1, User 2	
User	Text input (when User is set)	
Department Name	Text input (when User is set)	

(4)-1 End-of-Line Character

Specifies a New Line code used when controlling with the I/F command.

Selection	Description
CR+LF	Starts a new line with CR+LF codes.
LF	Starts a new line with LF code.
CR	Starts a new line with CR code.

(4)-2 USB Setting

Sets the USB ID number of the GL900.

Specify a number from 0 to 9.

When you control more than one unit of the GL900 with one PC, assign a unique USB ID to each of them

CAUTION

You must restart MT100 after any change is made to a setting value. Changes are applied upon restart.

(4)-3 TCP-IP Settings

Specifies TCP-IP settings used to connect the GL900 to an Ethernet.

Setting items	Description
IP Address	Sets the IP address of MT100 (0 to 255 . 0 to 255 . 0 to 255 . 0 to 255).
Subnet Mask	Sets the IP subnet mask of MT100 (0 to 255 . 0 to 255 . 0 to 255 . 0 to 255).
Port Number	Sets the port number of MT100 (1024 to 65535).
Gateway	Sets the gateway of MT100 (0 to 255 . 0 to 255 . 0 to 255 . 0 to 255).
DNS Address	Sets the DNS address of MT100 (0 to 255 . 0 to 255 . 0 to 255 . 0 to 255).

CAUTION

You must restart MT100 after any change is made to a setting value.
Changes are applied upon restart.

(4)-4 USER Settings

Setting items	Description
User	Specifies the user name. You cannot set this item when Guest is selected.
Department name	Specifies the department name. You cannot set this item when Guest is selected.
Change Conds	Switches between Guest, User 1, and User 2. Since setting conditions are stored for each user, they can be called up easily by simply switching the user.

(5) OTHR Settings

Other miscellaneous settings are made here.



Setting			Selections available
LCD Brightness			Light, Medium, Dark
Screen Saver			Off; 10, 30 (sec.); 1, 2, 5, 10, 30, 60 (min.)
Power On Start			Disable, Enable
Room Temp.			Internal, External
Temp. Unit			°C, °F
Background color			Black, White
Start/Stop Confirmation Message			On, Off
Date/Time	Date/Time	Date	January 1, 2005 to December 31, 2035
		Time	00:00:00 to 23:59:59 (Hour:Minute:Second)
	Network Time		Off, On
	Time Server		Text Input
	Time Zone		-12:00 to +13:00 (one-hour steps)
	Synchronized Time		00:00 to 23:59 (Hour:Minute)
	Synchronization Mode		Immediately, Gradually
	Connection Test		▷ Execute
Language			Japanese, English (US), English (UK), French, German, Chinese, Korean
Return to Default Settings			▷ Execute
Demo Waveform Mode			Off, On
Game			Memory test game, Number order game, Reversi, Blackjack, Speed, Sudoku
Information			▽ Show Information

(5)-1 LCD Brightness

Sets the brightness of the LCD backlight.

(5)-2 Screen Saver

Automatically turns off the display if the GL900 is not operated within a specified interval.

Turning off the display frequently using the screen Saver function allows longer lifetime of the LCD screen.

(5)-3 Power On Start

Sets the feature that automatically starts measurement when the GL900 is powered on.

Selection	Description
Disable	Disables the Power On Start function.
Enable	Enables the Power On Start function.

(5)-4 Room Temp. Compensation

Specifies the room temperature compensation in temperature measurement using a thermocouple.

Selection	Description
Internal	The GL900's room temperature compensation settings are used. (Usually you use this parameter.)
External	Set this parameter to use the room temperature compensation settings in external devices.

(5)-5 Temp. Unit

Toggles the temperature unit between °C (Celsius) and °F (Fahrenheit). (Selecting °F forcibly enables the scaling function.)

(5)-6 Background Color

Sets the background color of the waveform and digital display areas.

(5)-7 Start/Stop Confirmation Message

Specifies the setting of the confirmation message displayed when data capture is started and stopped.

Selection	Description
On	Enables the confirmation message. Pressing the Start/Stop key brings up the message, confirming whether you want to start (or stop) data capture. Pressing the
Off	Disables the confirmation message. Pressing the Start/Stop key immediately starts (or stops) data capture without displaying the message.

(5)-8 Date/Time

Sets the clock of the GL900.

Sets the built-in clock (Date/Time) of the GL900. If Network Time is set, the clock of the GL900 is automatically adjusted via the network. For details, see "Network Time Settings" on the next page.

(5)-9 Language

Sets the GL900's display language.

(5)-10 Demo Waveform Mode

Displays demo waveforms without analog signal input.

Selection	Description
Off	Do not display demo waveforms.
On	Display demo waveforms.

(5)-11 Return to Default Settings

Initializes the settings. After initialization, the settings are reset to the factory defaults.

(5)-12 Game

Six games are available. The score is stored for each user.

(5)-13 Information

Displays system information for the GL900.

Network Time Settings

The GL900 has a feature of synchronizing the time of the built-in clock with that of a time server via an Ethernet.

This menu is used to make settings required to use this feature.

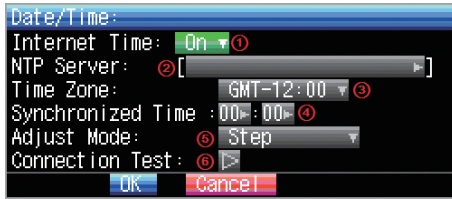

Setting	Selections available
Network Time	Enables or disables this feature. Off : Disables this feature. The time adjustment is not performed. On : Enables this feature. The time adjustment is performed.
Time Server	Specifies the domain name of the time server to be used.
Time Zone	Sets the time zone of the area in which the GL900 is to be used (Japan: +09:00).
Synchronized Time	Sets the time at which the GL900 clock is to be synchronized with the time server. When the setting time comes, the synchronization operation in the local country is performed with a method specified in Synchronization Mode.
Synchronization Mode	Immediately, Gradually Sets a method in which the clock is to be synchronized with the time server. Immediately : Immediately synchronizes the clock with the time server when the time for synchronization comes. Gradually : Does not immediately synchronize the clock when the time for synchronization comes. Gradually synchronizes the clock with the time server. The adjusted length of time is about 43 seconds per day (approximately equal to 10 ms per 20 seconds).
Connection Test	Performs a connection test by connecting to the time server. After the connection test is performed, a message is displayed. If connection fails, check the settings and conduct the connection test again. If the connection test is a success, the following message is displayed.

! CAUTION

The synchronization is not performed if the error with the time server is 500 ms or more.

(6) FILE Menu

This menu is used to perform file-related operations.



(6)-1 File Replay

Specify a file to replay data in the internal flash memory or USB memory. File replay is explained in detail on page 3-39.

(6)-2 File Operation

Operate files in the internal flash memory or USB memory. File operation is explained in detail on page 3-39.

(6)-3 Data Save

Save data remaining in the internal RAM to the internal flash memory or USB memory.

<If the Name Type is Auto>



<If the Name Type is User>



Setting	Description
(1) File Format	<p>Sets the file format in which you want to save data.</p> <p>GBD : Creates a data file in Graphtec proprietary binary format. * Prevents tampering of data.</p> <p>CSV : Creates a data file in a text format. * Cannot be replayed on the GL900.</p>
(3) Name Type	<p>Sets how a data file is named.</p> <p>Auto : Automatically gives a name to a file. Example: 20050101-123456_UG.GBD Number part Date and time at which a file was created * In this example, the date is January 1, 2005 and the time is 12:34:56.</p> <p>UG User number for data capture UG (Guest) U1 (User 1) U2 (User 2)</p> <p>GBD Data format GBD (Binary format) CSV (Text format)</p> <p>User : Captures data to a file with a user-defined name.</p>
(3) Folder	Specifies a folder to which you want to save data. For details, see the file box on page 3-39.
(4) File	Specifies a file to which you want to save data. For details, see the file box on page 3-39.

(6)-4 Bitmap Save

The GL900 can save a screen copy of waveforms, etc. to a bitmap file. This menu is used to specify the save destination, file name, etc. of a bitmap file.

<If the Name Type is Auto>



<If the Name Type is User>



Setting	Description
(1) Folder	Specifies a folder to which you want to save data. For details, see the file box on page 3-39.
(2) File	Specifies a file to which you want to save data. For details, see the file box on page 3-39.
(3) Name Type	Sets how a data file is named. Auto : Automatically gives a name to a file. Example: 20050101-123456_UG.GBD Number part Date and time at which a file was created * In this example, the date is January 1, 2005 and the time is 12:34:56. UG User number for data capture UG (Guest) U1 (User 1) U2 (User 2) BMP Data format (Bitmap file) User : Captures data to a file with a user-defined name.

(6)-5 Execute

Save a screen copy to a bitmap file. For information on specifying the save destination, see Section (6)-4, "Bitmap Save".

(6)-6 Save

Save the settings of the GL900.

<If the Name Type is Auto>



<If the Name Type is User>



Setting	Description
(1) Folder	Specifies a folder to which you want to save data. For details, see the file box on page 3-39.
(2) File	Specifies a file to which you want to save data. For details, see the file box on page 3-39.
(3) Name Type	Sets how a data file is named. Auto : Automatically gives a name to a file. Example: 20050101-123456_UG.GBD Number part Date and time at which a file was created * In this example, the date is January 1, 2005 and the time is 12:34:56. UG User number for data capture UG (Guest) U1 (User 1) U2 (User 2) CND Data format (Settings file format of the GL900) User : Captures data to a file with a user-defined name.

(6)-7 Load

Loads the settings of the GL900 from a file.



Setting	Description
(1) Folder	Specifies a folder to which you want to save data. For details, see the file box on page 3-39.

(7) File Box

Use the file box to specify a data save destination from the DATA menu or to operate a disk from the FILE menu as follows:

<File box for File Operation>

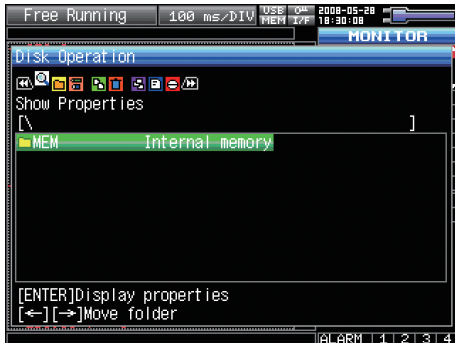

<File box for File Replay>

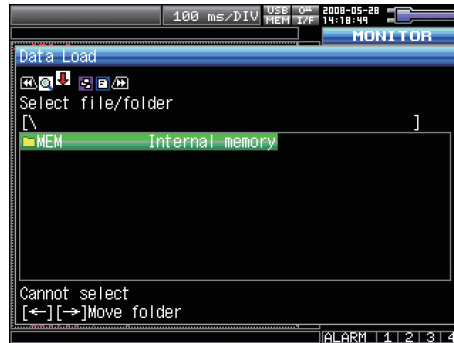

Key	Description
<div style="text-align: center;"> </div>	Changes the operation of the file box. Show properties Displays details of a file or folder. Select file/folder Selects files or folders to write data. Create new folder Creates a new folder. Create new file Creates a new file. Rename Changes the file or folder name. Copy file/folder Copies files or folders. Select file to copy/delete Selects the file to copy or delete. Select copy destination and copy Selects the copy destination and copies. Delete file/folder Deletes files or folders. File sort order Changes the order in which files are displayed. View setting Changes displaying information for files. Format disk Formats the disk. * Details of allowed operation will depend on the operation target.
<div style="text-align: center;"> </div>	Moves between folders. : Move up one folder : Move down one folder.
ENTER	Finalizes the operation.
QUIT	Closes the file box.

<Setting example>

The following shows an operation example for creating a "TEST" folder as the save destination and automatically saving captured data into it.



In the [Data Save Destination], choose [Folder] and press the ENTER key.



Use the ▷ key to move to the target folder.

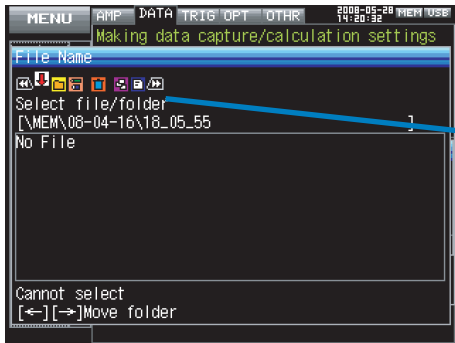

Use the ▷▷ key to select [Create new folder].

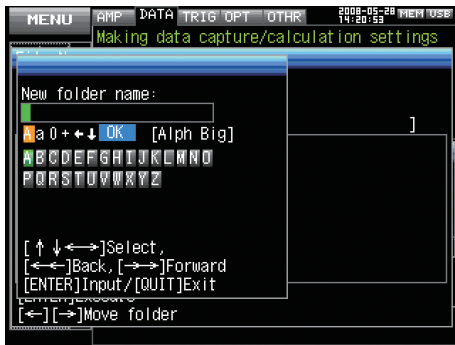

Press the ENTER key.

In the [New folder name] box that appears, type in "TEST".

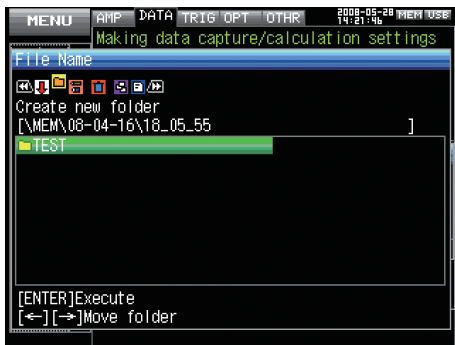

Use the ◀◀ key to choose [Select file/folder].

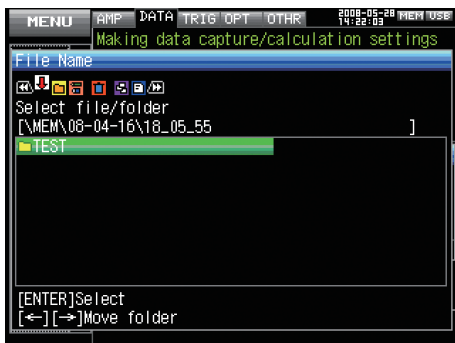

Use the ◀▽ key to move the cursor to the created "TEST" folder, and press the ENTER key.

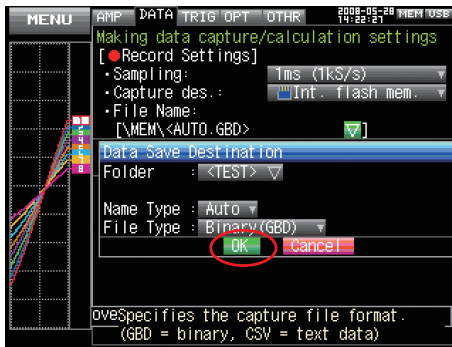

Select [OK] to close the screen.

(8) Text Input

This menu is used to specify the settings of text input operations such as annotation, EU (scaling) unit and captured data file name input.

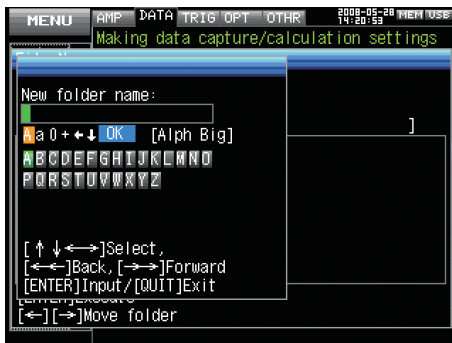

• Operation

Operation mode	Description	Operation method
Text input	A	Upper case alphabet mode
	a	Lower case alphabet mode
	0	Numeric mode
	+	Symbol mode
	←	Delete mode
	↓	Insert mode
	OK	Finalize mode
When selecting operation	Text used for each operation	When you bring the cursor to a character and press ENTER, the character is entered. After you finish entering characters, move the cursor to OK and then press ENTER.

(9) Data Replay Menu

When you press the MENU key during replay, the Data Replay Menu is displayed.



Setting		Selections available	
Cursor Position	Move to First Data		▷ Execute
	Move to Last Data		▷ Execute
	Move to Center		▷ Execute
	Move to Trigger Position		▷ Execute
	Move to	Method	Position, Time
Selected Position	[Position]	Move to	From 0 to Last Data For example, the position is up to 9999 ms if the sampling interval is 1 ms, the data capture destination is the internal RAM, and the number of capture points is 10000.
		[Time]	Date
	[Time]	Time	From the time of First Data to the time of Last Data
Cursor Sync	Off, On		
Data Search	Level	Combination	Edge OR, Edge AND
Statistical Calculation	Settings	Mode	Analog : Off, ↑ H, ↓ L, Win In, Win Logic : Off, ↑ H, ↓ L Pulse : Off, ↑ H, ↓ L, Win In, Win Out
		Level	Numeric value setting
		Alarm CH	Off, Output 1, Output 2, Output 3, Output 4
		Alarm CH mode	↑ Rising, ↓ Falling
	Next Search	▷ Execute	
	Prev. Search	▷ Execute	
Statistical Calculation	Statistical Calculation		Off, Average, Max, Min, Peak, RMS
between Cursors	Execute		▷ Execute
X-Y Display Settings	X-ch	CH1 to CH8	
	Y-ch	CH1 to CH8	
	Trace	Off, On	
Execute X-Y for All Data		▷ Execute	
Execute X-Y between Cursors		▷ Execute	

[xxx] shows a case in which xxx is selected from available selections.

(9)-1 Move to First Data

Moves the currently selected cursor (A or B) to the start of the data.

(9)-2 Move to Last Data

Moves the currently selected cursor (A or B) to the end of the data.

(9)-3 Move to Center

Moves the currently selected cursor (A or B) to the center of the data.

(9)-4 Move to Trigger Position

Moves the currently selected cursor (A or B) to the trigger position.

(9)-5 Move to Selected Position

Moves the currently selected cursor (A or B) to a selected position (relative position in time) or a specific point in time.

<If the Method is Position>

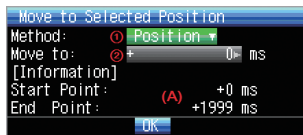

<If the Method is Time>

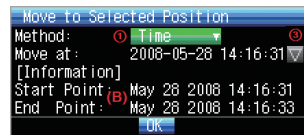

Setting	Selections available
(1) Method	Sets the method for specifying the moving destination. Either Position or Time can be selected.
(2) Position	Sets the moving destination as a relative position. Specify how much later the cursor should be moved from the capture start assumed as 0. Only a point up to the end of data can be specified. Check the setting range in the (A) part. * In the example in this figure, the sampling interval is 1 ms, the data capture destination is the internal RAM, and the number of capture points is 20000. Since the first point of data is 0 ms, only a position up to 19999 ms can be set.
(3) Time	Sets the moving destination as a date and time. Only a point between the start and the end can be set. Check the setting range in the (B) part.

(9)-6 Cursor Sync

Sets a function that moves the two cursors simultaneously when you move them.

Selection	Description
Off	The two cursors are not synchronized. Only the specified cursor moves.
On	The two cursors move in synchronization. Cursor A is always the fulcrum.

(9)-7 Level Settings

The Level Settings are the same as the Trigger Level Settings except that the Combinations include only edge operations (and no level operation) and the Alarm Output can be set to Rising (from Cleared to Generated) and Falling (from Generated to Cleared). See the Trigger and Alarm Level Settings on page 3-30. This section describes only how to specify the Alarm Output.

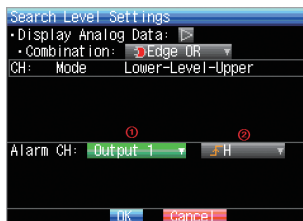

Setting	Selections available
(1) Alarm CH	Sets the alarm output to be used for search. Off : No alarm output is used for search. Output 1 to Output 4 : The specified output is used for search.
(2) Mode	Sets the search mode. ↑ Rising : Finds an edge at which the alarm output changes from Cleared to Generated. ↓ Falling : Finds an edge at which the alarm output changes from Generated to Cleared.

(9)-8 Next Search

Moves the cursor to a position after the current cursor position where the search conditions are met (Set the search conditions in Section (9)-7, "Level Settings").

(9)-9 Prev. Search

Moves the cursor to a position before the current cursor position where the search conditions are met (Set the search conditions in Section (9)-7, "Level Settings").

(9)-10 Calculation Function

Statistical calculation can be performed on the replay data between the cursors.

This menu is used to make settings for statistical calculation.

Selection	Description
Off	Calculation is not performed.
Average	Displays the simple average value of data being captured.
Max	Displays the maximum value of data being captured.
Min	Displays the minimum value of data being captured.
Peak	Displays the peak value of data being captured.
RMS	Displays the effective value of data being captured. The calculation formula is as shown below. $R.M.S = \sqrt{\sum D^2/n}$ * D : data n : number of data

(9)-11 (Calculation) Execute

Performs calculation between cursors. Opens a window and displays calculation results when Execute is selected.

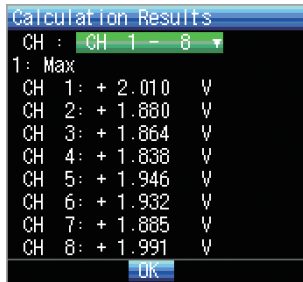

(9)-12 X-Y Display Settings

The GL900 can convert waveform data to X-Y display. This menu is used to assign channels and make other settings to convert the data to X-Y display.



Setting	Selections available
X-ch	Sets a channel to be assigned to the X-axis in each zone.
Y-ch	Sets a channel to be assigned to the Y-axis in each zone.
Trace	Turns on or off the display in each zone. On : Turns on the display of waveforms. Off : Turns off the display of waveforms in this zone.

(9)-13 Execute X-Y for All Data

Converts all the replay data to X-Y display when executed.

(9)-14 Execute X-Y between Cursors

Converts only the data between Cursors A and B to X-Y display when executed.

(10) NAVI Menu

The NAVI menu can be displayed in three modes, Free Running, Recording, and Replay.

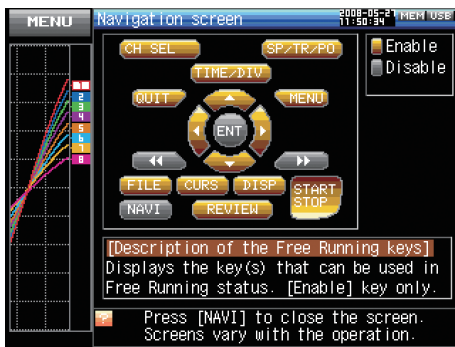

Operation	Description
Open	Press the NAVI key to open the NAVI menu.
Close	Press the NAVI key to close the NAVI menu.
Browse explanation	Explanation is displayed when an enabled key is pressed.

(11) Quick Settings

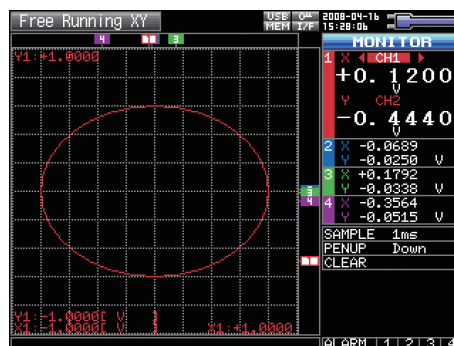
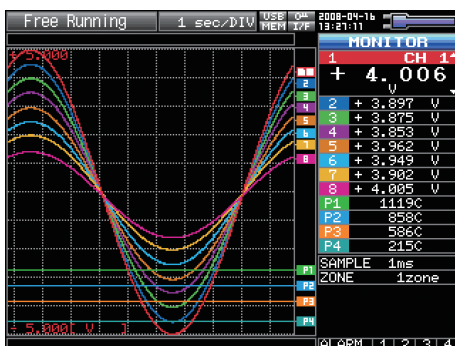

Screen	Operation mode	Content	Explanation
Waveform	Free Running	SAMPLE	< > key can be used to change the sampling interval.
		ZONE	< > key can be used to change the zone division.
	Recording	ZONE	< > key can be used to change the zone division.
	Capturing and Replaying	ZONE	< > key can be used to change the zone division.
	Replaying	SERCH	< > key can be used to perform search. < : Searches the past side. > : Searches the future side.
ZONE		< > key can be used to change the zone division.	
X-Y	Free Running	SAMPLE	< > key can be used to change the sampling interval.
		PENUP	< > key can be used to change the pen to Up or Down. When Up is set, new waveforms are not drawn.
		CLEAR	Press the < or > key to clear the waveforms on the screen.

(12) Canceling Key Lock with Password

A password can be set to GL800 to cancel the key lock.

(No password is set at factory default.)

<Operation method>

1. Set the password.

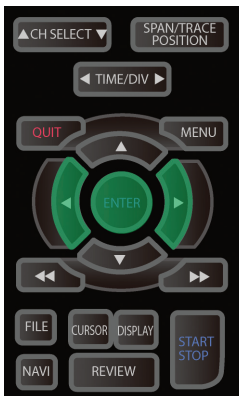

Press the <, >, and ENTER keys at the same time to display the password setting screen shown below. Specify a 4 digit password.



Use the <, >, Δ, ∇ keys to select numbers. Press the ENTER key to confirm the password.

Specifying 0000 will disable password operation.

In case you forgot your password, please contact our call center to acquire the master password.

2. Set the key lock.

Hold down the << and >> keys together for at least two seconds.

3. Cancel the key lock.

Hold down the << and >> keys together again for at least two seconds.

The password setting screen shown below will be displayed. Set a password.



Entering an incorrect password will not cancel key lock.

Key lock state will be retained when power is turned off.

3.5 WEB Server Function

This function allows operating and monitoring GL900 via a Web browser.

• Supported Web browsers

- Microsoft Internet Explorer 6.0 or later
- Netscape 6.2 or later
- Firefox 1.5 or later
- Opera 9.0 or later

• Available functions using a Web browser

- Operating GL900
- Monitoring GL900 display screen
- Enlarging GL900 display screen
- Linking to FTP
- Linking to our Web site

• Setting the URL

The URL (Uniform Resource Locator) must be correctly set according to your network environment. Follow the procedure below to access the GL900.

<http://IP address/index.html>

- http Protocol to access the server.
HTTP (Hyper Text Transfer Protocol)
- IP address Type in the IP address of the GL900 to monitor.
- index.html File name. This is fixed to index.html.

• Procedure

1. Open the Web browser.
2. Type in the URL (<http://IP address/index.html>) in the address input field.



3. The following pages are displayed.

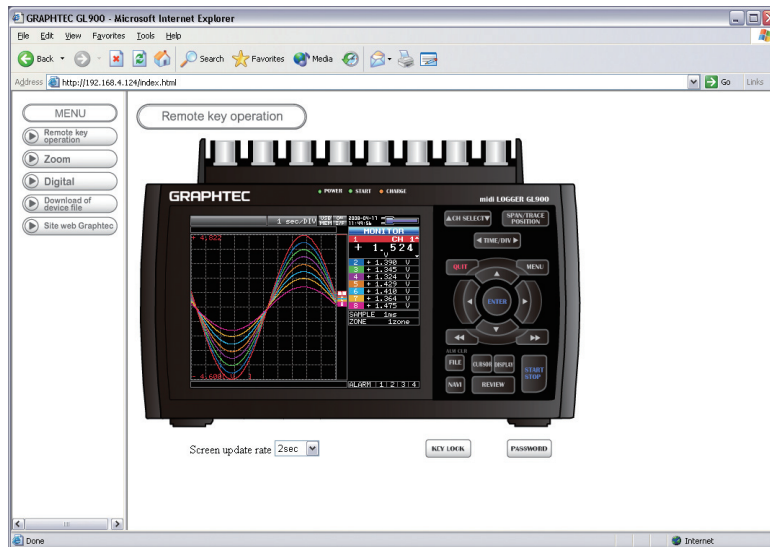

- Remote key operation Allows GL900 operation.
- Zoom Enlarges only the LCD screen of GL900.
- Digital Displays the GL900 measured value digitally.
- Download of device file Allows data captured with GL900 to be downloaded to your PC via FTP.
- Graphtec Web site Accesses to our Web site.

• Remote key operation

To operate GL900 from a remote location, click the corresponding GL900's panel keys on the screen.

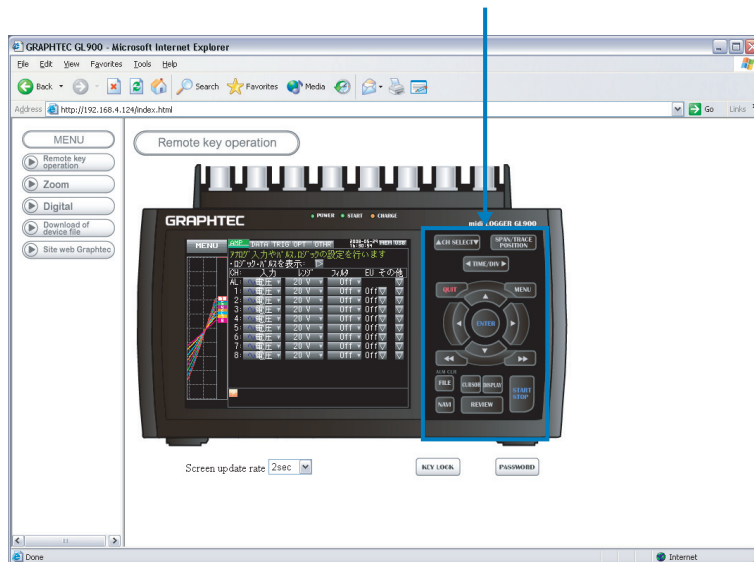

- KEY LOCK Sets and cancels key lock.
- PASSWORD Sets and cancels the password.

• Zoom

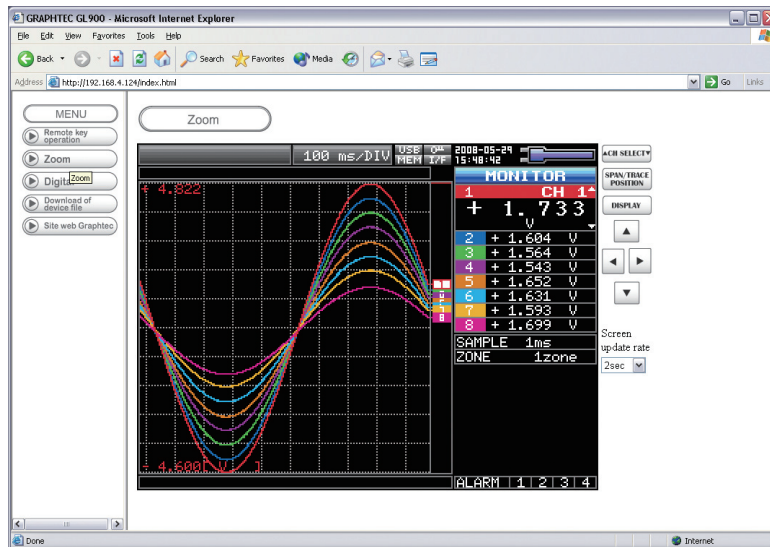

- CH SELECT Press this switch to move the active channel in the Waveform + Digital or X-Y screen.
- DISPLAY Switches the display mode.
Press this key to switch among Waveform + Digital, Expanded Waveform, Digital screens, and X-Y display.
- SPAN/TRACE/POSTION Switches the display in the digital display area.
Press this key to switch among MONITOR, SPAN, POSITION, and TRACE.
- ◀▶△▽ Cursor keys
- Screen update speed Specifies the speed in which the screen is updated.
Available update speeds are 2, 5, and 10 seconds.

• Digital

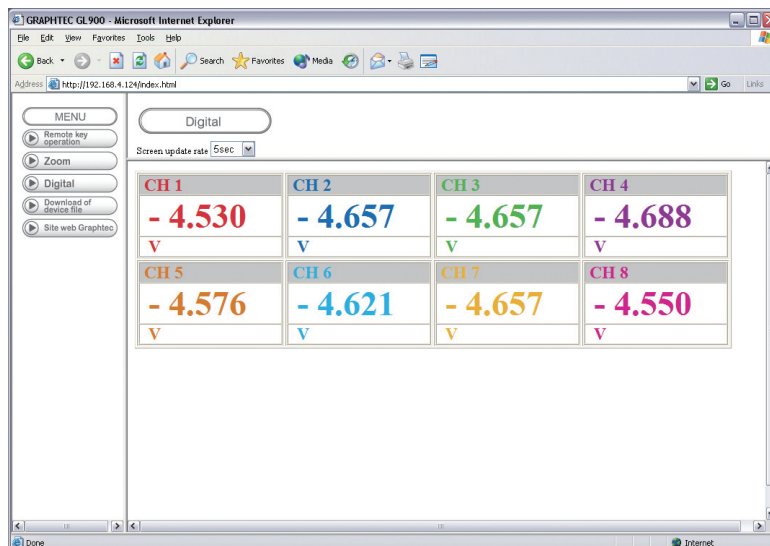

- Screen update speed Specifies the speed in which the screen is updated.
Available update speeds are 2, 5, and 10 seconds.

• **Download of device file**

Allows memory data from GL900 and data in USB memory to be downloaded to your PC.

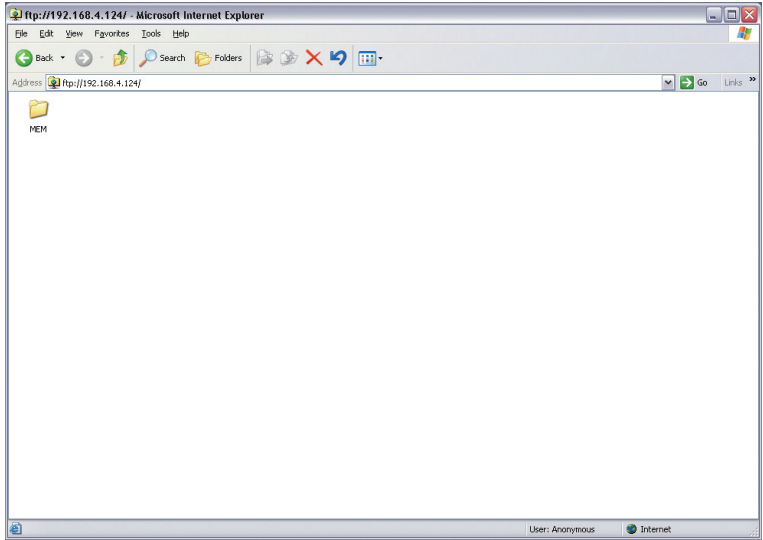

<About the FTP server function>

When an Internet Explorer FTP connection is used, login is automatically performed using an anonymous account and the files become read-only files.

The following operations cannot be performed for read-only files:

- Upload file
- Delete file/folder
- Create file/folder
- Change file name/folder name

To enable data to be written to the GL900, the login account name must be changed. please use the following table as a guide.

Account name	Password	Restrictions
GL900	None	None
gl900	None	None
Anonymous	Any	Read-only

The following procedure is used to change the Internet Explorer login account.

Go to the [File] menu and select [Login As...] to open the [login As] dialog box.

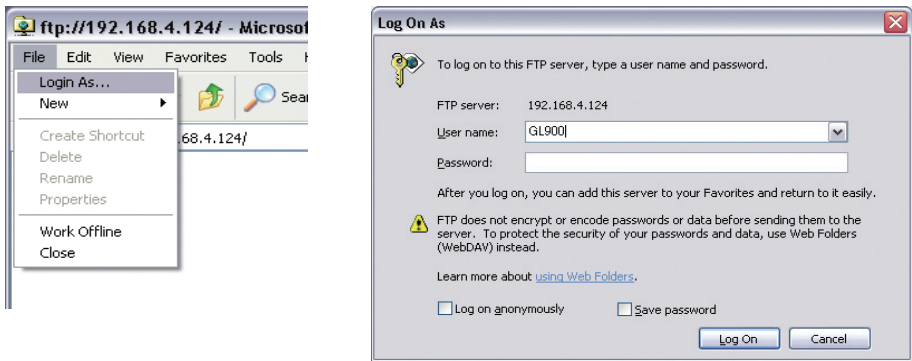

Enter the account name in the User Name box. leave the Password box blank.

Finally, click the “Login” button.

CHAPTER 4

Specifications

This chapter describes the basic specifications for the GL900.

- 4.1 Standard Specifications**
- 4.2 Function Specifications**
- 4.3 Accessory/Option Specifications**
- 4.4 External Dimensions**

4.1 Standard Specifications

Standard Specifications

Item	Description																																									
Number of analog channels	Fixed to 8 channels																																									
External input/output	Trigger input Logic input 4 channels or Pulse input 4 channels Alarm output																																									
PC interface	Ethernet (10BASE-T/100BASE-TX) USB (High Speed supported) provided as standard features																																									
Internal memory devices	Internal RAM : Approx. 64 MB Internal flash memory : Approx. 256 MB USB memory slot (High Speed supported) provided as standard features																																									
Data backup function	Setup condition: EEPROM; Clock: lithium secondary battery																																									
Clock accuracy (23°C environment)	±0.002% (accurate within about 50 seconds per month)																																									
Operating environment	0 to 40°C, 5 to 85% RH (15 to 35°C when using batteries)																																									
Withstand voltage	Between each input channel terminal and GND terminal : 1 minute at 1000 Vp-p Between input channel terminals : 1 minute at 1000 Vp-p																																									
Power supply	AC adapter : 100 to 240 VAC, 50/60 Hz DC input : 8.5 to 24 VDC Batory pack (option) : 7.4 VDC (2200 mAh)*2																																									
Power consumption	<ul style="list-style-type: none"> • AC current consumption (when using the AC adapter provided as a standard accessory) <table border="1"> <thead> <tr> <th>No</th> <th>Condition</th> <th>Normal</th> <th>During battery recharge</th> </tr> </thead> <tbody> <tr> <td>1</td> <td>When the LCD is on</td> <td>30VA</td> <td>42VA</td> </tr> <tr> <td>2</td> <td>When the screensaver is operating</td> <td>25VA</td> <td>37VA</td> </tr> </tbody> </table> • DC current consumption <table border="1"> <thead> <tr> <th>No</th> <th>DC voltage</th> <th>Condition</th> <th>Normal</th> <th>During battery recharge</th> </tr> </thead> <tbody> <tr> <td>1</td> <td rowspan="2">+24V</td> <td>When the LCD is on</td> <td>0.62A</td> <td rowspan="2">1.0A</td> </tr> <tr> <td>2</td> <td>When the screensaver is operating</td> <td>0.48A</td> </tr> <tr> <td>3</td> <td rowspan="2">+12V</td> <td>When the LCD is on</td> <td>1.16A</td> <td rowspan="2">Recharging not possible</td> </tr> <tr> <td>4</td> <td>When the screensaver is operating</td> <td>0.92A</td> </tr> <tr> <td>5</td> <td rowspan="2">+8.5V</td> <td>When the LCD is on</td> <td>1.82A</td> <td rowspan="2">Recharging not possible</td> </tr> <tr> <td>6</td> <td>When the screensaver is operating</td> <td>1.36A</td> </tr> </tbody> </table> <p><i>* Normal status is when LCD brightness is set to MAX.</i></p>	No	Condition	Normal	During battery recharge	1	When the LCD is on	30VA	42VA	2	When the screensaver is operating	25VA	37VA	No	DC voltage	Condition	Normal	During battery recharge	1	+24V	When the LCD is on	0.62A	1.0A	2	When the screensaver is operating	0.48A	3	+12V	When the LCD is on	1.16A	Recharging not possible	4	When the screensaver is operating	0.92A	5	+8.5V	When the LCD is on	1.82A	Recharging not possible	6	When the screensaver is operating	1.36A
No	Condition	Normal	During battery recharge																																							
1	When the LCD is on	30VA	42VA																																							
2	When the screensaver is operating	25VA	37VA																																							
No	DC voltage	Condition	Normal	During battery recharge																																						
1	+24V	When the LCD is on	0.62A	1.0A																																						
2		When the screensaver is operating	0.48A																																							
3	+12V	When the LCD is on	1.16A	Recharging not possible																																						
4		When the screensaver is operating	0.92A																																							
5	+8.5V	When the LCD is on	1.82A	Recharging not possible																																						
6		When the screensaver is operating	1.36A																																							
External dimensions	232 x 150 x 80 mm																																									
Weight*1	1.1 kg																																									
Vibration-tested conditions	Equivalent to automobile parts Type 1 Category A classification																																									

*1 Excluding the AC adapter and batteries

*2 Two battery packs (B-517: option) are required for the GL900 to run on batteries.

For details, see Section 2.9, "Using the Battery Pack (B-517: Option)".

Internal memory devices

Item	Description
Memory capacity	Internal RAM : Approx. 64 MB SDRAM Internal flash memory : Approx. 256 MB Flash Memory USB memory : Max. 2 GB (Depends on the type of USB memory in use)
Memory contents	Setup conditions Measured data Screen copy
Save destination specification	Internal RAM, internal flash memory, or USB memory * Neither the internal flash memory or USB memory can be selected if a unit in μs is selected.
Sampling speeds	10, 20, 50, 100, 200, 500 μ s* 1, 2, 5, 10, 20, 50, 100, 200, 500 ms 1, 2, 5, 10, 20, 30, 60 s * A unit in μs cannot be selected if the save destination is the internal flash memory or USB memory.
Setting of memory used for data capture	Set the number of data capture points. Setting range : 1000 to 1000000 points Setting unit : In steps of one point
Pre-trigger	0 to 100% (Set in steps of 10%)
Auto save function	ON or OFF setting ON : Automatically saves the data in the internal RAM to the internal flash memory or USB memory. OFF : Only temporarily retains data in the internal RAM (The data is lost at power-off). * This function is available only if data is captured to the internal RAM.

PC Interface

Item	Description
Interface types	Ethernet (10BASE-T/100BASE-TX) USB (High Speed)
Application functions	Data transfer to the PC (realtime, memory) Control of the GL900 from the PC
Ethernet functions (10BASE-T, 100BASE-TX)	Web server function : Displays GL900's screen image on Web browser and operates the GL900 from the Web browser. FTP server function : Transfers and deletes files from internal memory and USB memory. SNTP client function : Corrects the time of internal clock.
USB functions	USB drive mode : Transfers and deletes files from internal memory.
Realtime data transfer speed	1 ms to 60 s

Monitor

Item	Description
Display	5.7-inch TFT color LCD (QVGA: 320 x 240 dots)
Display languages	Japanese, English, Others
Backlight life	50,000 hrs (when brightness is down to 50%), depends on operation environment
Backlight	Screen saver function provided (10, 30 sec; 1, 2, 5, 10, 30, 60 min)

Input Unit Specifications

Item		Description																																													
Number of input channels		Fixed to 8 channels																																													
Input terminal type	Voltage	BNC connector																																													
	Temperature	M3 screw type terminal board																																													
Input method		All channels isolated Imbalanced input Simultaneous sampling of all channels																																													
Maximum sampling speed		10 μ s																																													
Measurement ranges	Voltage	20 m, 50 m, 100 m, 200 m, 500 m; 1, 2, 5, 10, 20, 50, 100, 200, 500 V; F.S., 1-5 V F.S.																																													
	Temperature	Thermocouples : K, J, E, T, R, S, B, N, W (WRe5-26)																																													
	Humidity	0 to 100% (voltage 0 V to 1 V scaling conversion) * with B-530 (option)																																													
Measurement accuracy*1 (23°C±5°C)		<ul style="list-style-type: none"> • Voltage ±0.25% of F.S. • Thermocouple <table border="1"> <thead> <tr> <th>Type</th> <th>Measurement temperature range</th> <th>Measurement accuracy</th> </tr> </thead> <tbody> <tr> <td rowspan="4">R/S</td> <td>0 ≤ TS ≤ 100</td> <td>±7.0°C</td> </tr> <tr> <td>100 < TS ≤ 300</td> <td>±5.0°C</td> </tr> <tr> <td>R:300 < TS ≤ 1600</td> <td>±(0.05% of rdg +3.0°C)</td> </tr> <tr> <td>S:300 < TS ≤ 1760</td> <td>±(0.05% of rdg +3.0°C)</td> </tr> <tr> <td rowspan="2">B</td> <td>400 ≤ TS ≤ 600</td> <td>±5.5°C</td> </tr> <tr> <td>600 < TS ≤ 1820</td> <td>±(0.05% of rdg +3.0°C)</td> </tr> <tr> <td rowspan="2">K</td> <td>-200 ≤ TS ≤ -100</td> <td>±(0.05% of rdg +3.0°C)</td> </tr> <tr> <td>-100 < TS ≤ 1370</td> <td>±(0.05% of rdg +2.0°C)</td> </tr> <tr> <td rowspan="2">E</td> <td>-200 ≤ TS ≤ -100</td> <td>±(0.05% of rdg +3.0°C)</td> </tr> <tr> <td>-100 < TS ≤ 800</td> <td>±(0.05% of rdg +2.0°C)</td> </tr> <tr> <td rowspan="2">T</td> <td>-200 ≤ TS ≤ -100</td> <td>±(0.1% of rdg +2.5°C)</td> </tr> <tr> <td>-100 < TS ≤ 400</td> <td>±(0.1% of rdg +1.5°C)</td> </tr> <tr> <td rowspan="3">J</td> <td>-200 ≤ TS ≤ -100</td> <td>±3.7°C</td> </tr> <tr> <td>-100 < TS ≤ 100</td> <td>±2.7°C</td> </tr> <tr> <td>100 < TS ≤ 1100</td> <td>±(0.05% of rdg +2.0°C)</td> </tr> <tr> <td>N</td> <td>0 ≤ TS ≤ 1300</td> <td>±(0.1% of rdg +2.0°C)</td> </tr> <tr> <td>W</td> <td>0 ≤ TS ≤ 2315</td> <td>±(0.1% of rdg +2.5°C)</td> </tr> </tbody> </table> <p>Reference contact compensation accuracy ±1.0°C *1: Thermocouple diameters T: 0.32ϕ, others: 0.65ϕ"</p>	Type	Measurement temperature range	Measurement accuracy	R/S	0 ≤ TS ≤ 100	±7.0°C	100 < TS ≤ 300	±5.0°C	R:300 < TS ≤ 1600	±(0.05% of rdg +3.0°C)	S:300 < TS ≤ 1760	±(0.05% of rdg +3.0°C)	B	400 ≤ TS ≤ 600	±5.5°C	600 < TS ≤ 1820	±(0.05% of rdg +3.0°C)	K	-200 ≤ TS ≤ -100	±(0.05% of rdg +3.0°C)	-100 < TS ≤ 1370	±(0.05% of rdg +2.0°C)	E	-200 ≤ TS ≤ -100	±(0.05% of rdg +3.0°C)	-100 < TS ≤ 800	±(0.05% of rdg +2.0°C)	T	-200 ≤ TS ≤ -100	±(0.1% of rdg +2.5°C)	-100 < TS ≤ 400	±(0.1% of rdg +1.5°C)	J	-200 ≤ TS ≤ -100	±3.7°C	-100 < TS ≤ 100	±2.7°C	100 < TS ≤ 1100	±(0.05% of rdg +2.0°C)	N	0 ≤ TS ≤ 1300	±(0.1% of rdg +2.0°C)	W	0 ≤ TS ≤ 2315	±(0.1% of rdg +2.5°C)
Type	Measurement temperature range	Measurement accuracy																																													
R/S	0 ≤ TS ≤ 100	±7.0°C																																													
	100 < TS ≤ 300	±5.0°C																																													
	R:300 < TS ≤ 1600	±(0.05% of rdg +3.0°C)																																													
	S:300 < TS ≤ 1760	±(0.05% of rdg +3.0°C)																																													
B	400 ≤ TS ≤ 600	±5.5°C																																													
	600 < TS ≤ 1820	±(0.05% of rdg +3.0°C)																																													
K	-200 ≤ TS ≤ -100	±(0.05% of rdg +3.0°C)																																													
	-100 < TS ≤ 1370	±(0.05% of rdg +2.0°C)																																													
E	-200 ≤ TS ≤ -100	±(0.05% of rdg +3.0°C)																																													
	-100 < TS ≤ 800	±(0.05% of rdg +2.0°C)																																													
T	-200 ≤ TS ≤ -100	±(0.1% of rdg +2.5°C)																																													
	-100 < TS ≤ 400	±(0.1% of rdg +1.5°C)																																													
J	-200 ≤ TS ≤ -100	±3.7°C																																													
	-100 < TS ≤ 100	±2.7°C																																													
	100 < TS ≤ 1100	±(0.05% of rdg +2.0°C)																																													
N	0 ≤ TS ≤ 1300	±(0.1% of rdg +2.0°C)																																													
W	0 ≤ TS ≤ 2315	±(0.1% of rdg +2.5°C)																																													
Reference contact compensation accuracy		Internal/External switching																																													
A/D converter		16 bits (out of which 14 bits are internally acknowledged)																																													
Temperature coefficient		Gain : 0.01% of F.S./°C Zero : 0.02% of F.S./°C																																													
Input resistance		1 M Ω ±5%																																													
Allowable signal source resistance		Within 1 kW																																													
Maximum permissible input voltage		Between input channel + and - terminals: 20 mv to 1 V → 30 Vp-p : 2 V to 500 V → 500 Vp-p Between input channel terminals : 60 Vp-p Between input channel terminal and GND terminal : 60 Vp-p																																													
Withstand voltage		Between input channel terminal and GND terminal : 1 minute at 1000 Vp-p Between input channel terminals : 1 minute at 1000 Vp-p																																													
Insulation resistance		Between input channel terminal and GND terminal : At least 50 M Ω (at 500 VDC)																																													
Common mode rejection ratio		At least 90 dB (50/60 Hz; signal source 300 Ω or less)																																													
S/N (Noise)		20 mV range : At least -40 dB Other range : At least -50 dB																																													
Frequency response		DC to 20 KHz (+1/-4 dB)																																													
Filter		OFF, Line, 5Hz, 50Hz, 500Hz (Attenuation) -3 dB / 6 dB oct																																													

4.2 Function Specifications

Function Specifications

Item	Description
Display screen	Waveform screen + Digital screen Expanded Waveform screen Digital screen X-Y display <i>* Even during data capture, you can open menus (to check whether setting is possible).</i> <i>* Screens can be key-toggled.</i>
EU (scaling function)	4 points can be set for each channel.
Review function	Data replay during data capture
Calculation	Types of statistical calculation : Average, Max, Min, Peak, RMS Number of operations : Maximum of 2 can be set simultaneously. Method : Data between cursors specified (during data replay)
Search functions	Function : Search the captured data for the required number of points Search type : Search of channels by levels Search by logic pulses + combinations Search by alarm generation
Annotation input function	Function : A comment can be input for each channel. Supported characters : Alphanumeric and kana characters Number of characters : 11 (Up to 8 characters are displayed)

Trigger Functions

Item	Description
Timer mode	Off, Date and Time, Every Day Cycle, Every Hour Cycle
Repeat trigger	Off, On
Trigger types	Start : Data capture starts when a trigger is generated. Stop : Data capture stops when a trigger is generated.
Trigger settings	Start : Off, Level, External Stop : Off, Level, External, Time <i>* A level can be set for each channel.</i>
Level judgment modes	Analog : \uparrow H, \downarrow L, Window IN, Window Out (Tolerance $\pm 1\%$) Logic : \uparrow H, \downarrow L Pulse : \uparrow H, \downarrow L, Window IN, Window Out
Channel combinations	Level OR, Level AND, Edge OR, Edge AND

External Input/Output Functions

Item	Description
Input/output types	Trigger input (1 ch) Logic input (4 ch) or Pulse input (4 ch) Alarm output (4 ch) <i>* Switch between Logic and Pulse</i>
Input specifications	Maximum input voltage : 0 to +24 V (single-ended ground input) Input threshold voltage : Approx. +2.5 V Hysteresis : Approx. 0.5 V (+2.5 V to +3 V)
Alarm output specifications	Output format : Open collector output (5 V, 10 K Ω pull-up resistance) Contact capacity 5 V to 24 V, 100 mA or below Output conditions : Level judgment, window judgment, logic pattern judgment, pulse judgment <i>* Alarm output is judged every 5 ms.</i>
Pulse input	Revolutions mode (engines, etc.) Function : Counts the number of pulses per second and multiplies it by 60 to display an rpm value. Spans : 5, 10, 20, 50, 100, 200, 500, 1 k, 2 k, 5 k, 10 k, 20 k, 50 k, 100 k, 200 k, 500 k, 1 M, 2 M, 5 M, 10 M, 20 M RPM/F.S.
	Counts mode (electric meters, etc.) Function : Displays a count of the number of pulses for each sampling interval from the start of measurement. Spans : 5, 10, 20, 50, 100, 200, 500 1 k, 2 k, 5 k, 10 k, 20 k, 50 k 100 k, 200 k, 500 k, 1 M, 2 M, 5 M, 10 M, 20 M C/F.S.
	Inst. mode Function : Counts the number of pulses for each sampling interval. Resets the count value after each sampling interval. Spans : 5, 10, 20, 50, 100, 200, 500 1 k, 2 k, 5 k, 10 k, 20 k, 50 k, 100 k, 200 k, 500 k, 1 M, 2 M, 5 M, 10 M, 20 M C/F.S.
	Maximum number of pulse inputs Maximum input frequency : 50 kHz Maximum number of counts : 15 MC (24-bit counter)

4.3 Accessory/Option Specifications

Control Software

Item	Description
Compatible operating system	Windows 2000, XP, Vista
Functions	Main unit control, realtime data capture, data conversion
Allowed connection	Up to 1
Settings	AMP settings, data settings, trigger/alarm settings, others
Captured data	Realtime data (Binary: 1ms to 60s CSV : 10ms to 60s) Data conversion (Binary, CSV)
Display	Analog waveforms, logic waveforms, pulse waveforms, digital values
Display modes	Y-T View, X-Y View, Digital View
File conversion	Between Cursors, All Data
Dual-screen function	Displays the current data alongs (Possible at sampling speeds of 1 ms to 60 s)
Statistic/History	Displays maximum, minimum, and average values.

Accessories

Item name	Description	Quantity
Quick Start Guide	GL900-UM-8xx	1
CD-ROM	GL900-CDM0xM (User Manual, Application Software)	1
Guarantee Card	Provided for a domestic model	1
AC adapter	100 to 240 VAC, 50/60 Hz, Power supply cord for each area	1 set

Battery Pack B-517 (Option)

Item	Description
Capacity	7.4 V/2200 mAh
Battery type	Lithium secondary battery
Running time	Up to two packs can be mounted (Two required for running on batteries; One sufficient for battery charging) <When LCD is ON> Battery pack x 2 (brightness MAX) : approx. 2 hours <When LCD is OFF> Battery pack x 2 : approx. 2.5 hours Note: These values are for when capturing a 1-second sample to the internal memory, using new battery packs in +25°C environment. Note: The running time depends on the operating environment.
Charging method	Mount in the main unit
Time required for charging	Battery pack x 1 : approx. 4 hours Battery pack x 2 : approx. 8 hours
Switchover in the case of a power failure	Because the battery is used together with the AC adapter, the power supply will be switched automatically to the battery in the event of a power failure. Note: The AC adapter is the primary power source.
Operating environment	15 to 35°C
Other functions	<ul style="list-style-type: none"> When the battery is running low, the file is closed automatically. (when data is captured to the internal memory or USB memory) There is a remaining amount indicator available.

Humidity Sensor B-530 (Option)

Item	Description
Allowable temperature range	-25 to +80°C
Allowable humidity range	0 to 100% RH
Relative humidity measurement accuracy	±3% RH (5 to 98% RH at 25°C)
Response time	15 s (90% response when membrane filter installed)
Sensor output	0 to 1 VDC
Sensor power source	+5 to +16 VDC
Current consumption	approx. 4 mA
External dimensions	φ14 mm x 80 mm (excluding cable)
Cable length	3 m

Options

Item name	Model	Description
Battery pack	B-517	7.4 V/2200 mAh*1
DC drive cable	B-514	2 m, bare tips
Humidity sensor	B-530	3 m, with dedicated power connector
Logic alarm cable	B-513	2 m, bare tips
Safe probe	RIC-141	1:1, 42pF
BNC-BNC cable	RIC-112	1.5 m
BNC-banana cable	RIC-113	1.5 m
BNC- alligator clip cable	RIC-114	1.5 m
K-type thermocouple (needle type probes)	RIC-410	1.1 m
K-type thermocouple (stationary surface probes)	RIC-420	1.1 m
K-type thermocouple (stationary surface L probes)	RIC-430	1.1 m

***1: Two battery packs (B-517: option) are required for the GL900 to run on batteries.**

For details, see Section 2.9, "Using the Battery Pack (B-517: Option)".

4.4 External Dimensions

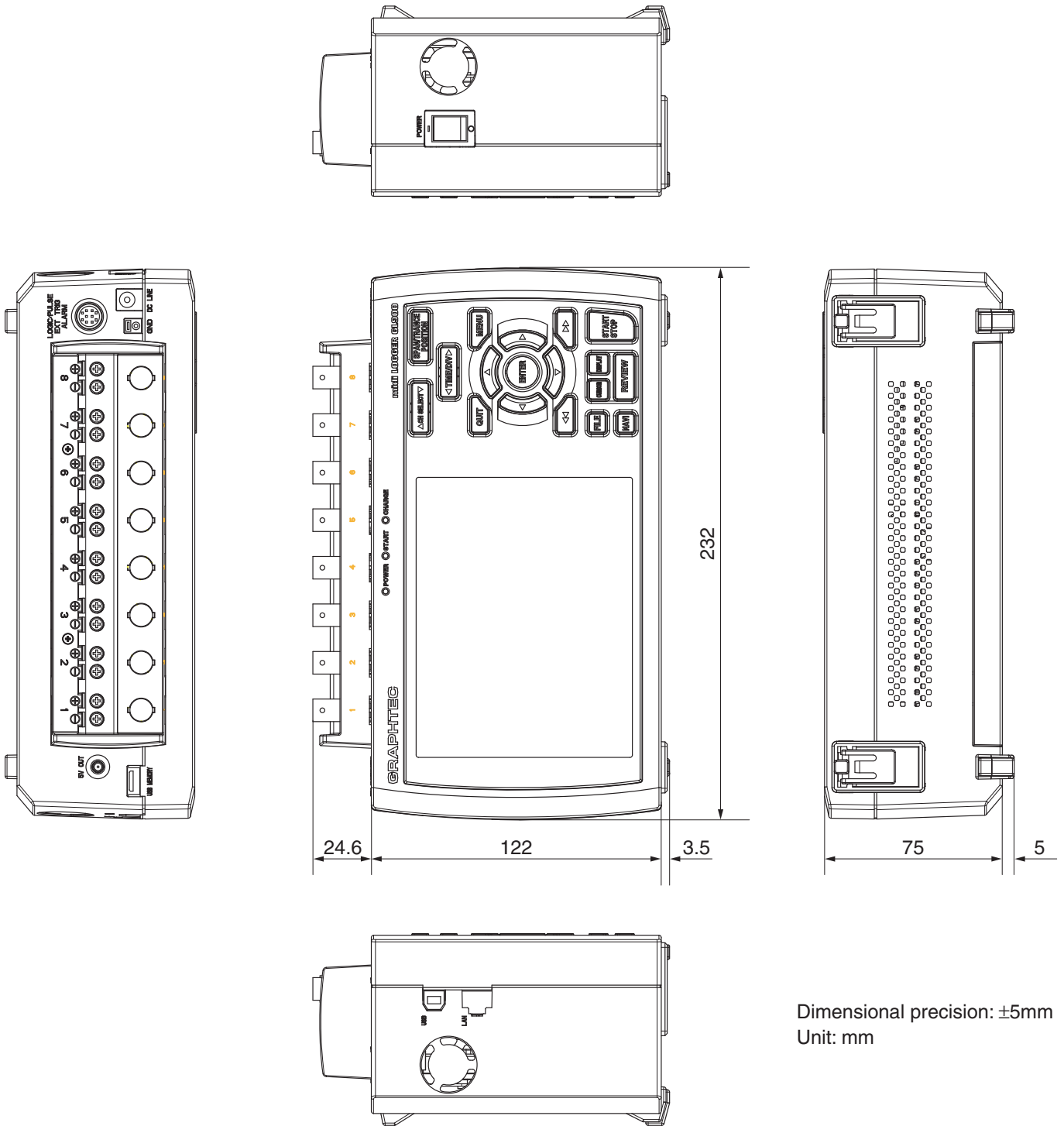

Dimensional precision: ±5mm
Unit: mm

Index

A

AC Power Supply, Connecting	2-4
Accessory	
Accessory Specifications	4-7
Checking the Accessories	2-2
Alarm	
Hold Generated Alarm	3-30
Operations	3-31
Setting	3-29
ALARM CLEAR	3-12
AMP settings	3-17
Annotation	3-21

B

Battery	
Battery Pack Specifications	4-7
Charging the Battery	2-13
Mounting the Battery Pack	2-12
Bitmap Save	3-37

C

Capturing	
Capturing	3-15
Capturing and Replaying	3-15
Data capture file name	3-23
Data Capturing Destination	3-24
Repeated Capturing	3-29
CH SELECT key	3-6
Changing the Display Language	3-35
Configuration When in Use	1-3
Control Software Specifications	4-7
CURSOR key	3-12

D

Data Replay Menu	3-42
Data Save	3-37
DATA settings	3-23
Date/Time	3-35
Setting the Date and Time	2-17
DC Power Supply, Connecting	2-5
Default settings	3-35
Demo Waveform Mode	3-35
Department name	3-33
Direction key	3-8
DISPLAY key	3-11

E

Edge Operations	3-31
ENTER key	3-9
EU (Scaling)	3-20, 3-22
External Dimensions	4-9
External Input/Output Function Specifications ...	4-6

F

FAST FORWARD key	3-9
Features	1-2
File Box	3-39
File Format	3-25, 3-37
FILE key	3-13
FILE Menu	3-36
Filter	3-19, 3-21
Free Running	3-14
Function Specifications	4-5

G

Game	3-35
Ground	
Connecting	2-4

H

Humidity Sensor Specifications	4-8
--------------------------------------	-----

I

Information	3-35
Input	3-18, 3-21
Input Unit Specifications	4-4
Internal flash memory	3-24
Internal memory device Specifications	4-3
Internal RAM	3-24
Interval	
Repeated Interval	3-29
Sampling Interval	3-23

K

KEY LOCK	3-9
Canceling Key Lock with Password	3-46

L

LAN Connection	2-11
Language	3-35
LCD Brightness	3-34
Level Operations	3-30
Logic	3-21

M

- MENU key 3-8
- Mode 3-14, 3-30
- MONITOR 3-7
- Monitor
 - Monitor Specifications 4-3
 - Notes on Using the Monitor 1-4

N

- Name Type 3-25, 3-37, 3-38
- NAVI key 3-13
- NAVI Menu 3-45
- Network Time settings 3-36
- Noise Countermeasure 2-16

O

- Operating Environment 1-3
- OPT settings 3-32
- Options 2-2, 4-8
- OTHER settings 3-33
- Outer Casing 2-2
- Overview 1-2

P

- Part Names and Functions 2-3
- PC Interface Specifications 4-3
- POSITION 3-7
- Power On Start 3-34
- Precautions to Observe
 - When Performing Measurement 2-15
- Pulse 3-21

Q

- Quick settings 3-45
- QUIT key 3-8

R

- Range 3-18
- Rechargeable Battery
 - How to Recharge the Rechargeable Battery . 2-17
- Replaying 3-16
- REVIEW key 3-10
- Room Temp Compensation 3-34

S

- Screen Saver 3-34
- Setting conditions
 - Change Conds 3-33
 - Load settings 3-38
 - Save settings 3-38

- Signal Types 2-6
- SPAN 3-7
- Span setting 3-7, 3-21
- SPAN/TRACE/POSITION key 3-7
- Standard Accessories 2-2
- Standard Specifications 4-2
- Start Side Source settings 3-28
- Start/Stop Confirmation Message 3-35
- START/STOP key 3-9
- Statistical Calculation settings 3-26
- Stop Side Source settings 3-28

T

- TCP-IP settings 3-33
- Temp Unit 3-34
- Temperature Measurement
 - Notes 1-4
- Terminal Configuration 2-6
- Text Input 3-41
- TIME/DIV key 3-7
- Timer Mode 3-28
- TRACE 3-7
- TRIG settings 3-27
- Trigger
 - Trigger Functions Specifications 4-5
 - Trigger Level settings 3-30
 - Trigger Operations 3-31

U

- Unit 3-20, 3-22
 - Select 3-20, 3-22
- USB Cable
 - Connection Using a USB Cable 2-10
- USB Drive mode 3-10
- USB memory 3-24
- USB settings 3-32
- USER settings 3-33

W

- Warming-up 1-3
- Window names and functions 3-2

The specifications, etc., in this manual are subject to change without notice.

GL900-UM-151

June 1, 2008 1st edition-01

GRAPHTEC CORPORATION

GRAPHTEC CORPORATION

503-10 Shinano-cho, Totsuka-ku,
Yokohama 244-8503, Japan

Tel : +81(045)825-6250

Fax : +81(045)825-6396

Email : info@graphteccorp.com

Web : www.graphteccorp.com

Printed in Japan