

## **USER'S GUIDE**

Installation & Operation  
Instructions

Level-Velocity Logger

Model Stingray

Manual Series A.3.2

Note: This page has been left blank intentionally.

**INDEX**

FUNCTION TEST..... 5

BATTERY INSTALLATION..... 5

CONFIDENCE DISPLAY ..... 6

CALIBRATION ..... 6

INSTALLATION - SENSOR LOCATION ..... 7

ENCLOSURE INSTALLATION..... 9

RS232 CONNECTION ..... 10

GREYLINE LOGGER SOFTWARE..... 10

START-UP ..... 11

FIELD TROUBLESHOOTING ..... 17

FREQUENTLY ASKED QUESTIONS..... 18

SENSOR CLEANING INSTRUCTIONS..... 19

APPLICATIONS HOTLINE..... 20

APPENDIX A - OPTIONS ..... 23

SPECIFICATIONS..... 25

*IMPORTANT NOTE: This instrument is manufactured and calibrated to meet product specifications. Please read this manual carefully before installation and operation. Any unauthorized repairs or modifications may result in a suspension of the warranty.*

*Available in Adobe Acrobat pdf format*

## Quick Start Guide Stingray Level-Velocity Logger

1. Install 4 Alkaline D-cell batteries (included). Allow 10 seconds for the Stingray to activate then press the button on the face of the Stingray. The LCD display will turn On. If the display does not turn On check that batteries have been correctly installed. After 1 minute the display will turn Off automatically.

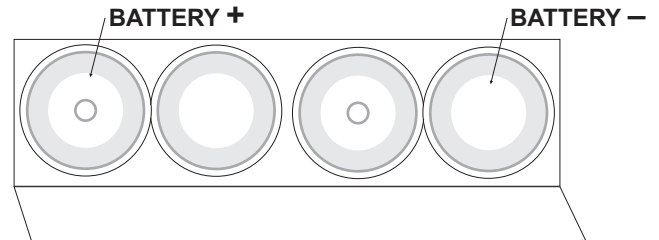

2. Install Greyline Logger software on your Windows PC or laptop computer. Insert the CD and run Setup.exe. If you encounter error messages during installation, open and review the readme.txt file on the CD.



3. Connect the Stingray to your PC or laptop with the RS232 cable (included). Run Greyline Logger and review the 'Quick Start Guide' instructions which appear onscreen or select the Help drop-down menu.

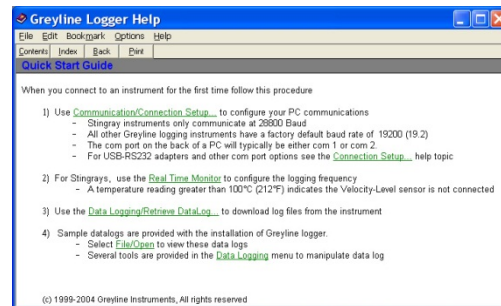

4. Configure Greyline Logger software Communication Settings. Stingray baud rate is fixed at 28800 Baud. Identify the serial port on your laptop or PC. Refer to the Greyline Logger 'Help' file 'Connection Setup' for detailed instructions if you are not sure which COM port or virtual port you are connected to. Greyline Logger also supports connection though a USB/RS232 convertor or an RS232/485 adaptor.

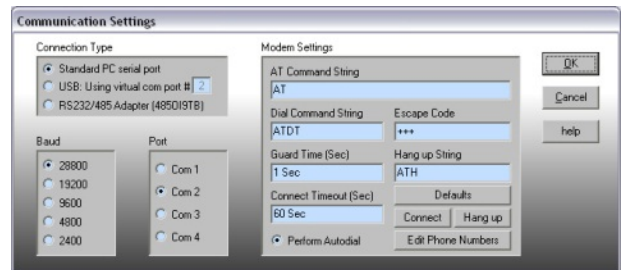

5. Configure the logging interval through Greyline Logger software's Real Time Monitor. Select a logging interval and click "Write" to properly initialize the Stingray.



## **INTRODUCTION:**

The Greyline Stingray Level-Velocity Logger measures and data logs level, velocity and fluid temperature in open pipes and channels. It is designed for flow surveys in sewers, streams and irrigation channels.

## **FUNCTION TEST:**

1. Connect the sensor plug to the watertight fitting on the Stingray enclosure.
2. Install 4 new Alkaline D-Cell batteries. Close battery lid and latch shut.
3. Wait 10 seconds then press the display button on the face of the Stingray to activate the LCD display.
4. Place the QZ02L sensor (flat to the bottom) in a bucket of water about 6"/150mm deep. Double press the display button to freeze on selected parameter. Stir the water to cause motion over the sensor and display a velocity reading.

## **BATTERY INSTALLATION:**

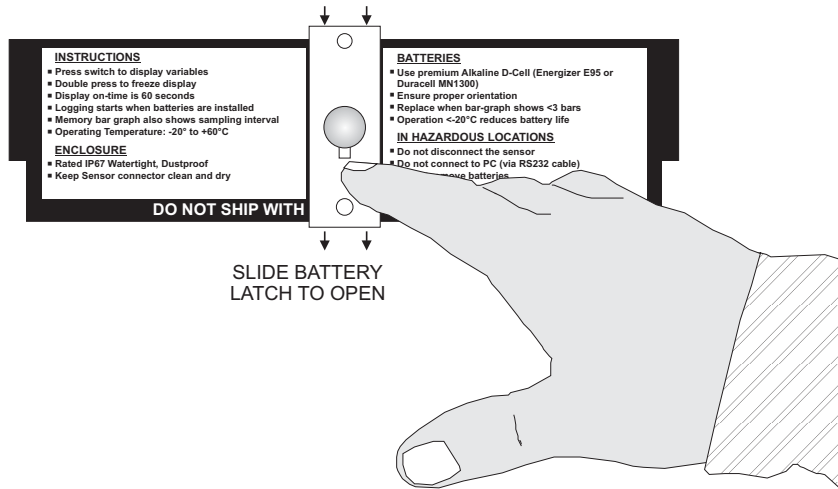

Use new, premium quality Alkaline D-Cell batteries only (Energizer E95 or Duracell/Procell MN1300).

Insert batteries as shown:

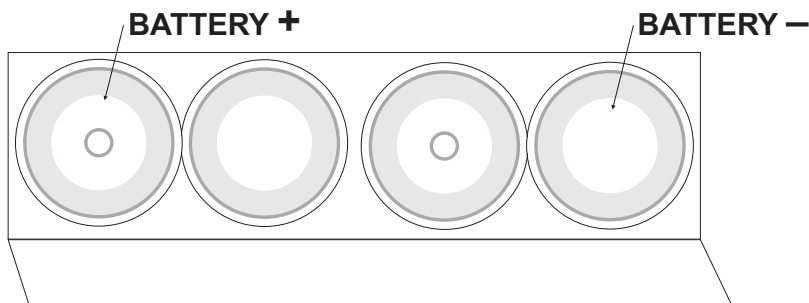

## **CONFIDENCE DISPLAY**

The Stingray includes a built-in Bargraph display. Activate the display by pressing the button on the instrument face. It will scroll between level, velocity, temperature, remaining battery power and remaining logger capacity. To conserve battery power, the display will shut Off after 1 minute.

Double press the button to freeze the display on one parameter (Parameter flashes).

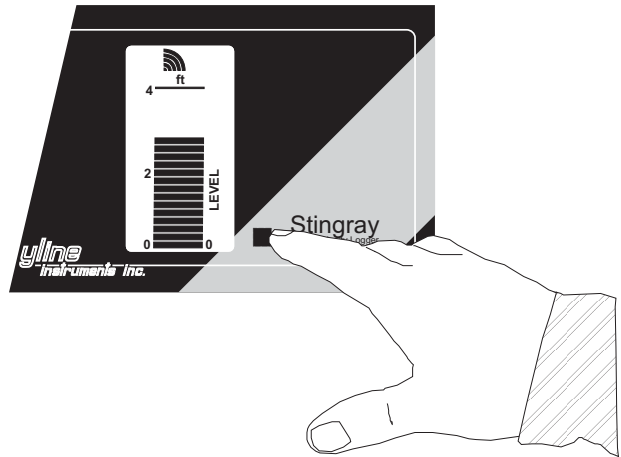

## **CALIBRATION**

*Stingray does not require field calibration.*

It is factory-calibrated to measure level from the bottom of the pipe or channel to the water surface (maximum 15 ft / 4.5 m), and velocity from 0 to 10 ft/sec (0 to 3.05 m/sec).

## INSTALLATION - SENSOR LOCATION

1. Choose a sensor mounting location where silt or deposits are least likely to accumulate.
2. For best results flow should be evenly distributed across the channel and relatively free of turbulence. (The Stingray is very effective at averaging level and velocity readings in turbulent conditions, but best accuracy and response time is achieved with evenly distributed flow.)
3. Avoid vertical drops, obstructions or elbows immediately up and downstream from the sensor. Locate the QZ02L sensor at least 10 times maximum Head (level) and 10 times the channel width from these flow disturbances.

## QZ02L VELOCITY-LEVEL SENSOR MOUNTING

Mount the QZ02L sensor with the stainless steel bracket and hardware supplied. Ensure that the sensor is parallel to the water surface (check with a level). Mount with the tapered end of the sensor pointing upstream and the sensor cable pointing downstream.

Clip or tie wrap the sensor cable securely to the pipe or channel wall.

Note: The mounting bracket is designed to release the sensor if weeds or rags are caught by the sensor.

The QZ02L sensor requires a minimum water level of 1" (25.4 mm) above the bottom of the pipe or channel.

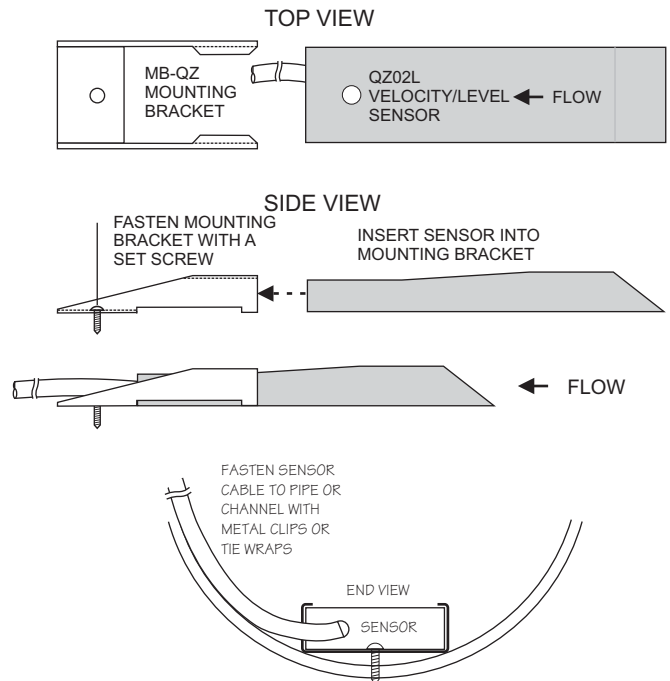

## GOOD

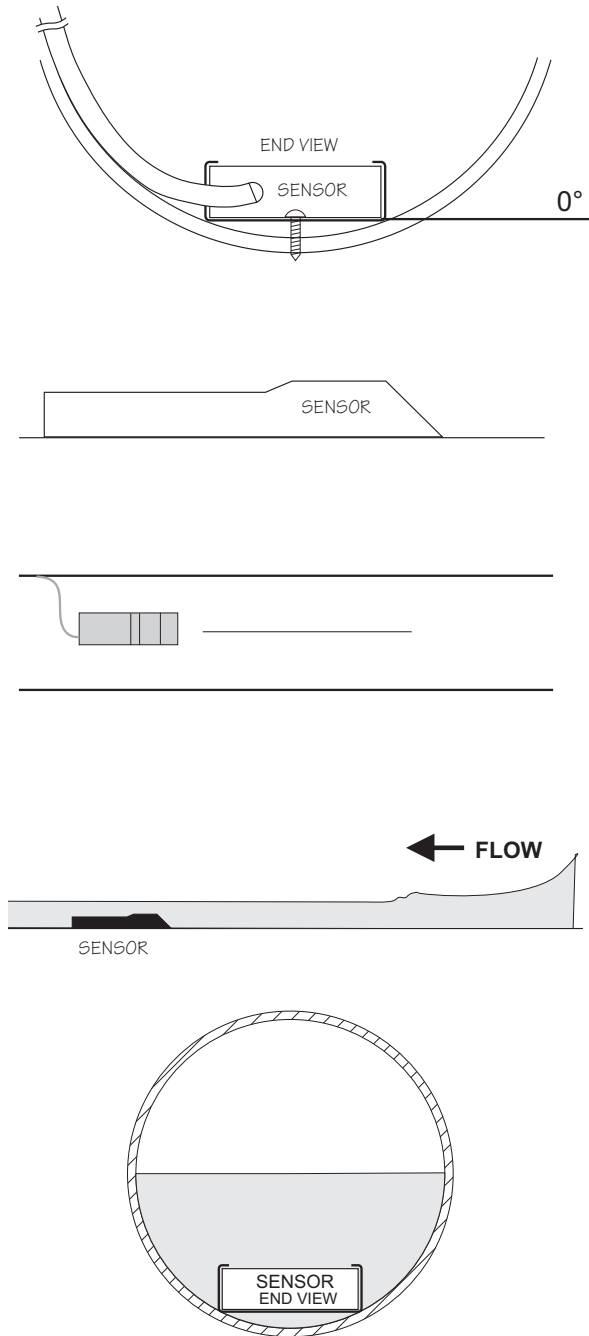

## BAD

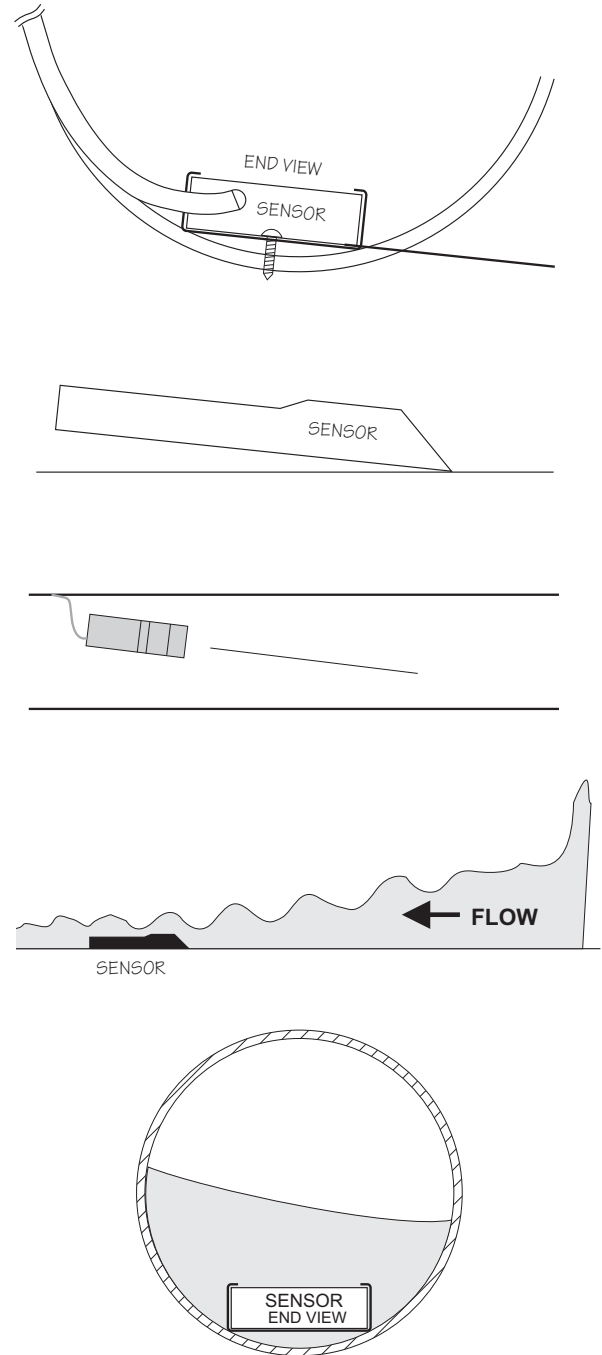



## **OPTIONAL PIPE BAND MOUNTING WITH QZ02L SENSOR**

Install the stainless steel pipe band with the sensor mounting bracket at the invert (bottom) of the pipe. Ensure that the sensor bracket is parallel to the water surface (check with a level). Mount so the tapered end of the sensor will point upstream and the sensor cable will point downstream. (Turn the ¼” hex nut clockwise to expand the bracket and secure to the pipe wall by friction fit.)

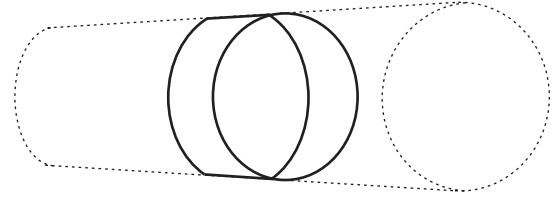

Insert the sensor into the mounting bracket and clip or tie wrap the sensor cable securely to the stainless steel pipe band as illustrated.

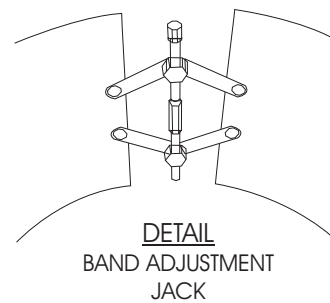
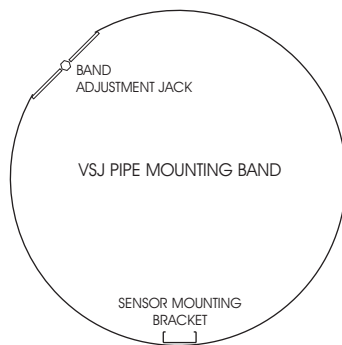

## **ENCLOSURE INSTALLATION**

Close the Stingray cover and ensure that the sensor cable connector is tightened snugly for a watertight seal (do not damage the connector by over tightening the coupling). Wipe the enclosure cover gasket with a clean cloth to remove dirt or grit before closing.

Use a chain or mounting bracket to hang the enclosure from the manhole ladder or any available secure location. The enclosure should be located above the high water level so that it will not be accidentally submerged.

Stingray is rated for operation from -20°C to 60°C (-4°F to 140°F). The batteries will not function below the rated temperature. To prevent overheating, avoid mounting the enclosure in direct sunlight.

Stingray enclosure is rated IP67, watertight and dustproof.

## RS232 CONNECTION

Use the 9-pin RS232 connector supplied with each Stingray for communication with a PC computer or laptop. It may be connected directly to a PC computer or laptop COM port, or connected through a USB to RS232 converter.

With modem connection the Stingray will automatically select 19,200 Baud or 9600 Baud. The modem must be V.32 compatible.

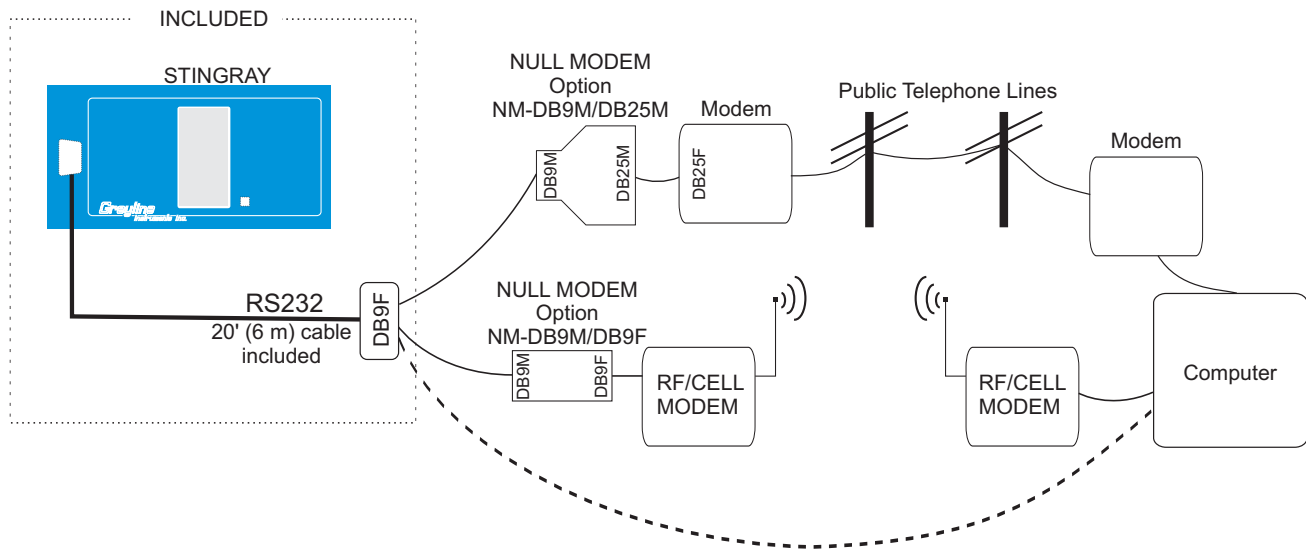

## GREYLINE LOGGER SOFTWARE

Greyline Logger (for Windows) is supplied with each Stingray and is required to download log files and to set the logging interval of the Stingray data logger. Install on any PC running Windows 98/2000/Me/NT/XP. Requires a PC with an RS232 port or a USB to RS232 converter and at least 5MB of available disk space.

**NOTE:** Refer to the Greyline Logger Help menu for complete instructions on using this software. The following information covers only basic functions of this powerful software program.

## START-UP

When you connect to a Stingray for the first time follow this procedure:

1. Use **Communication/Connection Setup** to configure your PC for communications.
2. Use **Real Time Monitor** to configure the logging frequency and click **Write** to initialize logging, date and time. Date and time are read by the Stingray from your PC.
3. Use **Retrieve DataLog** to download log files from a Stingray.

## CONNECTION SETUP

Configure communications with the Stingray through the Communication menu. Select **Connection Setup**.

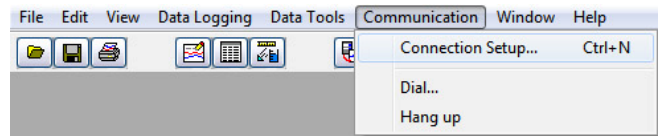

Refer to the Greyline Logger **Help** file for detailed instructions. Select the **Connection Type** according to your PC setup.

Use **Standard PC serial port** if your PC or laptop has an RS232 port, otherwise use a USB to RS232 converter and select **USB Using virtual com port**.

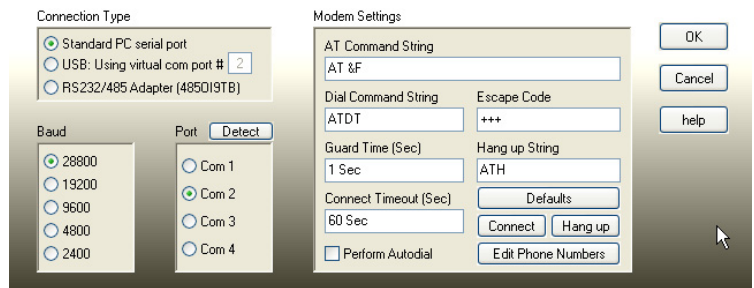

Stingray baud rate is fixed at 28800 and Greyline Logger baud rate must be set at 28800 to match.

**Modem Settings** are only required if you will connect to a Stingray through modems and telephone lines. Refer to the Greyline Logger **Help** for more detailed instructions.

## REAL TIME MONITOR

Select **Data Logging/Real Time Monitor ON** to view 'real-time' level, velocity and temperature from the connected Stingray. Readings are updated every 10 seconds.

Remaining Logger capacity and remaining battery power are indicated.

## LOGGING INTERVAL

Use the **Logging Settings** selector to change the Stingray's logging interval, then press the **Write** button to transmit the new setting to the Stingray.

**IMPORTANT:** **Write** action deletes existing log file and begins a new data log. Download and save existing log files before executing **Write**.

The Stingray will take measurements for 10 seconds and record the sampled data. It will then enter a low power "sleep" mode for the remainder of the interval time. While in sleep mode, the Stingray consumes minimal power. This means that the logging interval also determines the battery life of the instrument. The table below shows the maximum amount of time the Stingray can log while at a constant 68 °F (20 °C).

Low temperatures and varying battery quality will reduce the amount of time the Stingray can log until the batteries need to be changed. Because of their higher power capacity, and better low temperature characteristics, it is recommended that only premium quality Alkaline D-cell batteries (Energizer E95 or Duracell MN1300) be used in the Stingray.



Logging Interval	Logging Time and Battery Life
10 Seconds	15 Days
30 Seconds	45 Days
1 Minute	3 Months
2 Minutes	6 Months
5 Minutes	1 Year
10 Minutes	2 Years
30 Minutes	4 Years
60 Minutes	4 Years

**NOTE:** It is a good practice to download and save an existing log file and then install new batteries when you start (**Write**) a new data log.

## MEMORY WRAP AROUND

Click the **Wrap Around On** box to enable data wrap around. When the Stingray data log is full, and wrap around is enabled, the Stingray will overwrite the oldest data at the beginning of the log. This allows the Stingray to always have a record of the most recent flow events. If this option is unchecked (deselected), the Stingray will stop logging when the data log is full and keep the log in memory until a new log is started.

## RETRIEVE LOG

Ensure that communications settings are properly configured under the **Communications / Connection Setup** menu. Connect a Stingray using the RS232 cable supplied.

Click the Retrieve Log  icon or select **Data Logging / Retrieve Log** from the drop down menu. Greyline Logger will download the log file and a graph window will open.

Click and drag the mouse pointer across a section of the graph to zoom in or press the **Zoom In** icon to view portions of the flow log.

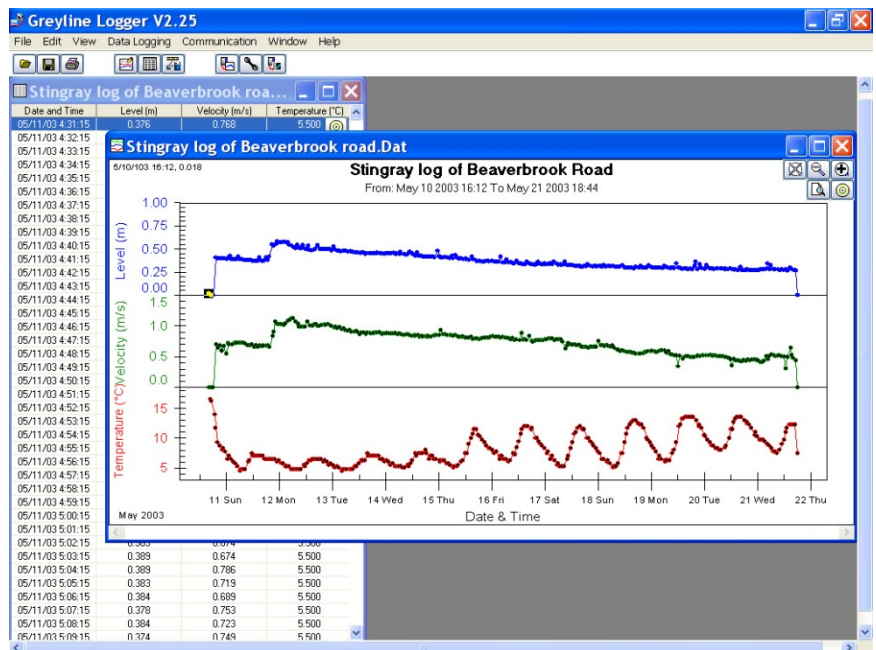

Click the **Show Data Table**  icon or select **View / Data Table** drop down menu to open a table view of the log file.

Select **File/Save** to save a copy of the log file (with a .DAT file extension). The file can be reopened using **File/Open** menu.

## FLOW CALCULATION

Click **Generate Flow Log** from the drop down menu to calculate flow. Greyline Logger supports flow calculation for common channel shapes:

- Round pipe
- Square channel
- Egg shape pipe
- Trapezoid channel

Select the **Channel Type** and enter the dimensions. **Level Offset** should be set to **0.000** unless the sensor is elevated above the bottom of the channel or pipe.

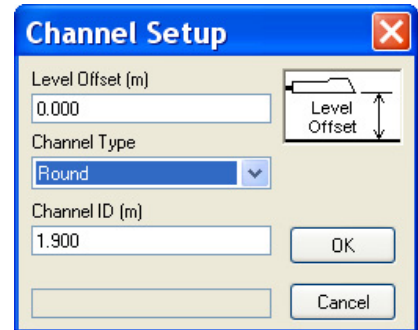

### Round

Select **Round** for open pipes and enter the pipe ID (Inside Diameter).

### Square

Select **Square** for rectangular channels and enter the width of the channel.

### Egg

Select **Egg** for channels with cross-section dimensioned as shown.

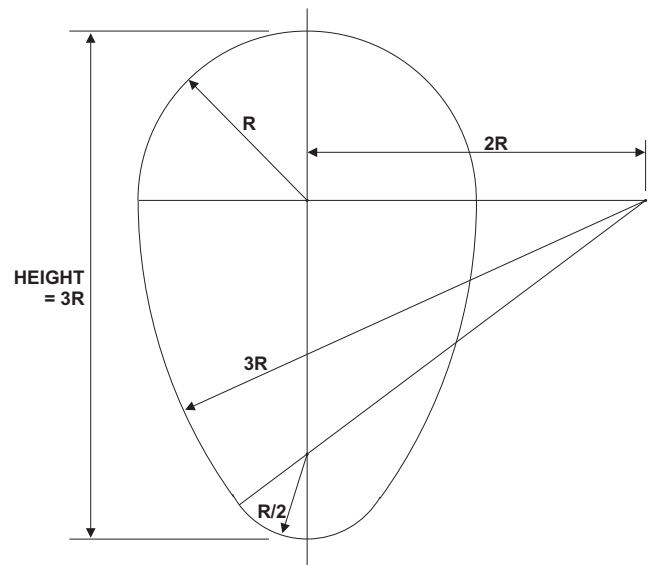

### Trapezoid

Select for trapezoidal shaped channels. Enter **Width** and **Slope**.

V shaped channels may also be monitored where the channel width is entered as 0.



		SLOPE = $\frac{\text{RISE}}{\text{RUN}}$				
e.g.#1	WIDTH =	24"		e.g.#2	WIDTH =	1 m
	RUN =	10"			RUN =	0.35 m
	RISE =	12"			RISE =	0.5 m
	SLOPE =	1.2			SLOPE =	1.429

NOTE: To calculate flow for channel shapes other than Round, Square, Egg or Trapezoid, export the data (**File/Export Data**) and perform the flow calculation using a spreadsheet program like Microsoft Excel and your own conversion formula.

## Flow Calculation for Flumes and Weirs

Greyline Logger supports flow calculation from level data log files for the following:

- V-Notch Weirs
- Parshall Flumes
- Palmer Bowlus Flumes
- Leopold Lagco Flumes
- Rectangular Weirs
- Rectangular Weirs with End Contractions
- Khafagi Flumes
- Trapezoidal Flumes
- Custom Flumes

To collect level data the Stingray sensor should be installed at the correct location in the flume or weir for level/flow measurement.

### To Generate a Flow Log

1. Select **Data Tools** from the drop down menu and then click **Extract Level Data**. A new graph window will open with Level data only.

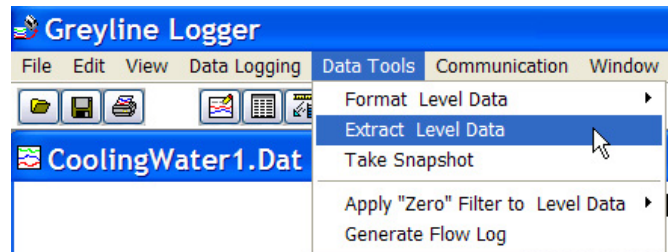

2. Select **Data Tools** from the drop down menu and then click **Generate Flow Log**. The **Channel Setup** window will open.

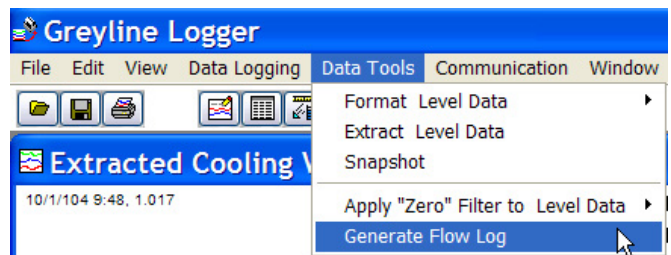

3. From the **Channel Setup** window select your flume type and then **Flume Size**. Click **OK** and a new Flow log window will open indicating flow for the flume or weir you selected.

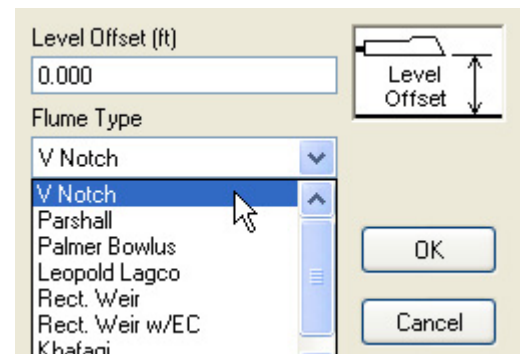

4. Use the **View** drop down menu and click **Change Units** to change flow volume units as required.



## **FIELD TROUBLESHOOTING**

The Stingray uses an ultrasonic level sensor to determine water LEVEL and an ultrasonic Doppler sensor to measure flow VELOCITY.

The QZ02L transducer combines both sensors in one housing.

<b><u>SYMPTOMS</u></b>	<b><u>FAULTS</u></b>	<b><u>SOLUTIONS</u></b>
Pressing display button does not turn on LCD display	Batteries not installed properly	Check battery polarity
	Battery latch not fully closed	Slide latch to the fully closed position
	Batteries dead	Replace batteries with 4 premium quality Alkaline D-Cell
	Operating below minimum temperature	Rated for operation above -4°F / -20°C
	New batteries just installed	Allow 10 seconds for Stingray to activate after installation of new batteries
Level reading zero with level >1" / 25.4 mm	Sensor not connected	Connect sensor
	No echo detected	Sensor misaligned. Use a level to confirm sensor mounting is horizontal
	Sensor coated with debris or sediment	Clean sensor with a soft brush
Level reading correct but not changing	Batteries discharged	Replace batteries with 4 premium quality Alkaline D-Cell
	Sample rate	Stingray LCD display and Greyline Logger real-time display are refreshed every 10 seconds.
Level reading not correct and not changing	Extreme turbulence	Relocate sensor where water surface is calm and evenly distributed
	Debris attached to sensor or mounting structure	Clean sensor with a soft brush and remove debris
Level reading is erratic	Extreme turbulence and highly aerated water	Relocate sensor where water surface is calm and evenly distributed
	Sensor coated with debris or sediment	Clean sensor with a soft brush
Velocity reading is zero with flow	Sensor not connected	Connect sensor
	Sensor coated with debris or sediment	Clean sensor with a soft brush

<u>SYMPTOMS</u>	<u>FAULTS</u>	<u>SOLUTIONS</u>
Velocity reading is correct but not changing	Batteries too low to sample, displays last recorded value	Replace batteries with 4 premium quality Alkaline D-Cell
Velocity reading with no flow	Wave action on water surface or upstream turbulence	Relocate sensor
Temperature display is blank	Fluid temperature is below 5°F / -15°C	Minimum fluid temperature for sensor operation is 5°F / -15°C
Temperature displayed in Greyline Logger is 103.5°C / 218.3°F	Sensor not connected	Connect sensor
Memory capacity display is 0%	Data logger memory is full	Run Greyline Logger software - download log file - click <b>Write</b> from real-time display to restart the logger

## **FREQUENTLY ASKED QUESTIONS**

### *1. How to turn Stingray On and Off?*

Stingray is On when batteries are installed. Default logger rate is 30 seconds which will run for 45 days before filling the logger memory and discharging the batteries. To turn Off the Stingray remove the batteries.

### *2. Is logger memory retained with batteries removed and Stingray Off?*

Yes, logger memory is maintained with Stingray batteries removed. The only way to delete logger memory is through Greyline Logger software **Real-Time display** and clicking **Write**.

### *3. How long do D-cell Alkaline batteries last?*

New D-cell Alkaline batteries will power the Stingray for the same time duration as the logger capacity. Refer to “Logging Interval” in this manual.

**SENSOR CLEANING INSTRUCTIONS BEFORE HANDLING**

Stingray sensors that have been immersed in sewage should be cleaned before handling.

1. Rinse sensor and cable to remove debris.
2. Immerse sensor and cable in a solution of 1 part household bleach (Javex, Clorox etc.) to 20 parts water for 5 minutes. Do not immerse open end of sensor cable or cable plug. Ensure that the protective cap is properly fitted to the cable plug before immersing in water or cleaning solution
3. Remove grease from sensor with clean water and mild soap. Do not use abrasive cleaners, solvents or high pressure washers.

**SENSOR CLEANING WHILE STINGRAY IS IN OPERATION**

Use a soft brush or broom to wipe the sensor face. DO NOT USE an abrasive tool or gouge the surfaces of the sensor.

Remove the sensor from its mounting bracket to remove severe build-up of debris or “stringers” attached to the sensor, cable or mounting bracket.



**APPLICATIONS HOTLINE**

For applications assistance, advice or information on any Greyline Instrument contact your Sales Representative, write to Greyline or phone the Applications Hotline below:

United States:	Tel: 315-788-9500	Fax: 315-764-0419
Canada:	Tel: 613-938-8956	Fax: 613-938-4857
Toll Free:	888-473-9546	
Email:	info@greyline.com	
Web Site:	http://www.greyline.com	

Greyline Instruments Inc.

Canada  
16456 Sixsmith Drive  
Long Sault, Ont. K0C 1P0

USA:  
105 Water Street  
Massena, NY 13662

## **PRODUCT RETURN PROCEDURE**

Instruments may be returned to Greyline for service or warranty repair.

- 1** Obtain an RMA Number from Greyline -  
Before shipping a product to the factory please contact Greyline by telephone, fax or email to obtain an RMA number (Returned Merchandise Authorization). This ensures fast service and correct billing or credit.

When you contact Greyline please have the following information available:

1. Model number / Software Version
2. Serial number
3. Date of Purchase
4. Reason for return (description of fault or modification required)
5. Your name, company name, address and phone number

- 2** Clean the Sensor/Product -  
**Important: unclean products will not be serviced and will be returned to the sender at their expense.**

1. Rinse sensor and cable to remove debris.
2. If the sensor has been exposed to sewage, immerse both sensor and cable in a solution of 1 part household bleach (Javex, Clorox etc.) to 20 parts water for 5 minutes. Important: do not immerse open end of sensor cable.
3. Dry with paper towels and pack sensor and cable in a sealed plastic bag.
4. Wipe the outside of the enclosure to remove dirt or deposits.
5. Return to Greyline for service.

- 3** Ship to Greyline -  
After obtaining an RMA number please ship the product to the appropriate address below:

*Canadian and International  
Customers:*

Greyline Instruments Inc.  
16456 Sixsmith Drive  
Long Sault, Ont. K0C 1P0

RMA#

*USA  
Customers:*

Greyline Instruments Inc.  
204 150th Avenue  
Madeira Beach, FL 33708

RMA#

## LIMITED WARRANTY

---

Greyline Instruments warrants, to the original purchaser, its products to be free from defects in material and workmanship for a period of one year from date of invoice. Greyline will replace or repair, free of charge, any Greyline product if it has been proven to be defective within the warranty period. This warranty does not cover any expenses incurred in the removal and re-installation of the product.

If a product manufactured by Greyline should prove defective within the first year, return it freight prepaid to Greyline Instruments along with a copy of your invoice.

This warranty does not cover damages due to improper installation or handling, acts of nature, or unauthorized service. Modifications to or tampering with any part shall void this warranty. This warranty does not cover any equipment used in connection with the product or consequential damages due to a defect in the product.

All implied warranties are limited to the duration of this warranty. This is the complete warranty by Greyline and no other warranty is valid against Greyline. Some states do not allow limitations on how long an implied warranty lasts or limitation of incidental or consequential damages, so the above limitations or exclusions may not apply to you.

This warranty gives you specific legal rights, and you may also have other rights which vary from state to state.

Greyline Instruments Inc.

**APPENDIX A - OPTIONS**

**SENSOR CABLE EXTENSION  
(OPTION PVXC5)**

Each Stingray QZ02L sensor includes 25 ft. (7.6 m) submersible tri-coaxial sensor cable. This cable is shielded from electrical interference and is watertight with a polyurethane jacket.

Extend sensor cable an additional 50 ft (15 m) with one PVXC5 Sensor Cable Extension connected between the Stingray enclosure and the sensor. The extension includes watertight, submersible connector plugs.

NOTE: Use only one PVXC5 Sensor Cable Extension for a total cable length of 75 ft (23 m).

## SS PIPE MOUNTING BAND - OPTION VSJ

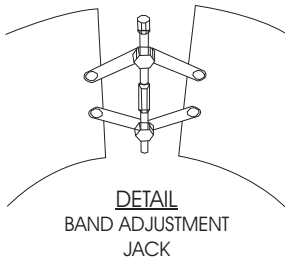

Use optional VSJ stainless steel Pipe Mounting Bands for easy Sensor installation in round pipes.

Each Pipe Band includes:

- Band Adjustment Jack allowing  $\pm 0.5"$  (13 mm) adjustment from the nominal band size
- Stainless steel bracket for Sensor mounting
- Pre-drilled for tie wraps (included) to secure Sensor cable

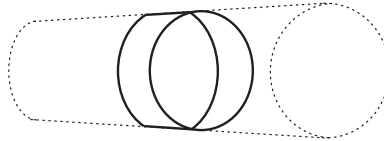
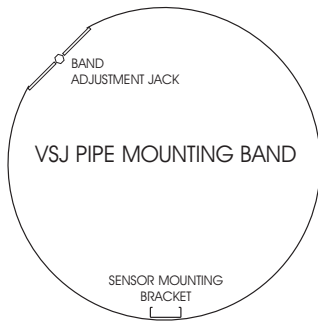

### CODE BAND SIZE

CODE	BAND SIZE
VSJ6	6"/150 mm ID pipes
VSJ8	8"/200 mm ID pipes
VSJ10	10"/250 mm ID pipes
VSJ12	12"/300 mm ID pipes
VSJ14	14"/350 mm ID pipes
VSJ15	15"/375 mm ID pipes
VSJ16	16"/400 mm ID pipes
VSJ18	18"/450 mm ID pipes
VSJ20	20"/500 mm ID pipes
VSJ24	24"/600 mm ID pipes
VSJ30	30"/750 mm ID pipes

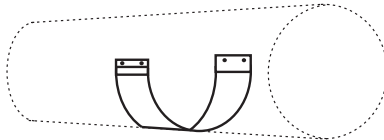
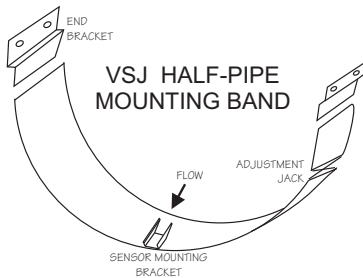

VSJ32-40	32-40" / 800-1000 mm ID pipes
VSJ42-54	42-54" / 1100-1375 mm ID pipes
VSJ56-72	56-72" / 1400-1800 mm ID pipes

### Mounting Instructions:

Install the stainless steel pipe band with the sensor mounting bracket at the invert (bottom) of the pipe. Ensure that the sensor bracket is parallel to the water surface (check with a level). Mount so the tapered end of the sensor will point upstream and the sensor cable will point downstream. Turn the  $\frac{1}{4}"$  hex nut clockwise to expand the bracket and secure to the pipe wall by friction fit.

Insert the sensor into the mounting bracket and clip or tie wrap the sensor cable securely to the stainless steel pipe band.

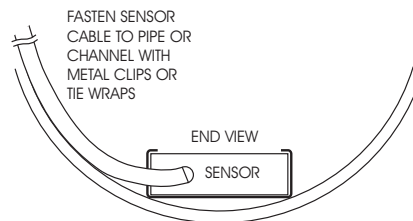

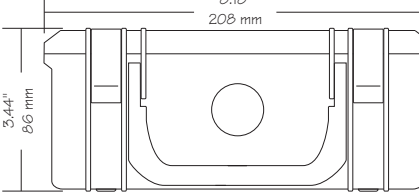
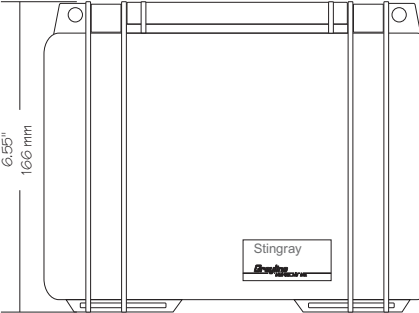

## SPECIFICATIONS

<b>Electronics Enclosure:</b>	Watertight, airtight, dust proof (IP 67) polycarbonate	
<b>Accuracy:</b>	Level: $\pm 0.25\%$ of Range. Velocity: $\pm 2\%$ of Reading	
<b>Display:</b>	LCD displays: Level, Velocity, Water Temperature, Battery and Memory capacity	
<b>Operating Temp. (electronics):</b>	-4° to 140°F (-20° to 60°C)	
<b>Instrument Set-up:</b>	via Greyline Logger software for Windows: Logging Time Interval, Site Name	
<b>Logger Interval:</b>	10 sec (15 days), 30 sec (45 days), 1 min (3 months), 2 min (6 months), 5 min (1 year), 10 min (2 years), 20 min (4 years)	
<b>Data Logger Capacity:</b>	130,000 data points	
<b>Power:</b>	4 Alkaline 'D' cells	
<b>Output/Communications:</b>	RS232, 28,800 Baud	
<b>RS232 Cable:</b>	20 ft (6 m) shielded with DB9 M/F connectors	
<b>Software:</b>	Greyline Logger for Windows. Supports real-time monitoring, log file download and export, graph and data table presentation, level/velocity to flow conversion	

## Velocity/Level Sensor QZ02L

<b>Velocity Measurement Range:</b>	0.1 to 10 ft/sec (0.03 to 3.05 m/sec)
<b>Level Measurement Range:</b>	Minimum Head: 1 in (25.4 mm). Maximum Head: 15 ft. (4.5 m)
<b>Operating Temperature:</b>	5 to 150°F (-15 TO 65°C)
<b>Exposed Materials:</b>	PVC, polyurethane, epoxy
<b>Sensor Cable:</b>	25 ft. (7.6 m) submersible polyurethane jacket, shielded, 3 coaxial
<b>Sensor Mounting:</b>	includes MB-QZ stainless steel mounting bracket
<b>Temperature Compensation:</b>	Automatic, continuous

