

# ALNOR® LOFLO BALOMETER® CAPTURE HOOD

---

OWNER'S MANUAL

P/N 116620001, REV 09  
FEBRUARY 2016



---

## LIMITATION OF WARRANTY AND LIABILITY

(effective February 2015)

(For country-specific terms and conditions outside of the USA, please visit [www.tsi.com](http://www.tsi.com).)

Seller warrants the goods, excluding software, sold hereunder, under normal use and service as described in the operator's manual, to be free from defects in workmanship and material for **24 months**, or if less, the length of time specified in the operator's manual, from the date of shipment to the customer. This warranty period is inclusive of any statutory warranty. This limited warranty is subject to the following exclusions and exceptions:

- a. Hot-wire or hot-film sensors used with research anemometers, and certain other components when indicated in specifications, are warranted for 90 days from the date of shipment;
- b. Pumps are warranted for hours of operation as set forth in product or operator's manuals;
- c. Parts repaired or replaced as a result of repair services are warranted to be free from defects in workmanship and material, under normal use, for 90 days from the date of shipment;
- d. Seller does not provide any warranty on finished goods manufactured by others or on any fuses, batteries or other consumable materials. Only the original manufacturer's warranty applies;
- e. This warranty does not cover calibration requirements, and seller warrants only that the instrument or product is properly calibrated at the time of its manufacture. Instruments returned for calibration are not covered by this warranty;
- f. This warranty is **VOID** if the instrument is opened by anyone other than a factory authorized service center with the one exception where requirements set forth in the manual allow an operator to replace consumables or perform recommended cleaning;
- g. This warranty is **VOID** if the product has been misused, neglected, subjected to accidental or intentional damage, or is not properly installed, maintained, or cleaned according to the requirements of the manual.
- h. Unless specifically authorized in a separate writing by Seller, Seller makes no warranty with respect to, and shall have no liability in connection with, goods which are incorporated into other products or equipment, or which are modified by any person other than Seller.

The foregoing is **IN LIEU OF** all other warranties and is subject to the **LIMITATIONS** stated herein. **NO OTHER EXPRESS OR IMPLIED WARRANTY OF FITNESS FOR PARTICULAR PURPOSE OR MERCHANTABILITY IS MADE. WITH RESPECT TO SELLER'S BREACH OF THE IMPLIED WARRANTY AGAINST INFRINGEMENT, SAID WARRANTY IS LIMITED TO CLAIMS OF DIRECT INFRINGEMENT AND EXCLUDES CLAIMS OF CONTRIBUTORY OR INDUCED INFRINGEMENTS. BUYER'S EXCLUSIVE REMEDY SHALL BE THE RETURN OF THE PURCHASE PRICE DISCOUNTED FOR REASONABLE WEAR AND TEAR OR AT**

### **SELLER'S OPTION REPLACEMENT OF THE GOODS WITH NON-INFRINGEMENTS GOODS.**

TO THE EXTENT PERMITTED BY LAW, THE EXCLUSIVE REMEDY OF THE USER OR BUYER, AND THE LIMIT OF SELLER'S LIABILITY FOR ANY AND ALL LOSSES, INJURIES, OR DAMAGES CONCERNING THE GOODS (INCLUDING CLAIMS BASED ON CONTRACT, NEGLIGENCE, TORT, STRICT LIABILITY OR OTHERWISE) SHALL BE THE RETURN OF GOODS TO SELLER AND THE REFUND OF THE PURCHASE PRICE, OR, AT THE OPTION OF SELLER, THE REPAIR OR REPLACEMENT OF THE GOODS. IN THE CASE OF SOFTWARE, SELLER WILL REPAIR OR REPLACE DEFECTIVE SOFTWARE OR IF UNABLE TO DO SO, WILL REFUND THE PURCHASE PRICE OF THE SOFTWARE. IN NO EVENT SHALL SELLER BE LIABLE FOR LOST PROFITS, BUSINESS INTERRUPTION, OR ANY SPECIAL, INDIRECT, CONSEQUENTIAL OR INCIDENTAL DAMAGES. SELLER SHALL NOT BE RESPONSIBLE FOR INSTALLATION, DISMANTLING OR REINSTALLATION COSTS OR CHARGES. No Action, regardless of form, may be brought against Seller more than 12 months after a cause of action has accrued. The goods returned under warranty to Seller's factory shall be at Buyer's risk of loss, and will be returned, if at all, at Seller's risk of loss.

Buyer and all users are deemed to have accepted this LIMITATION OF WARRANTY AND LIABILITY, which contains the complete and exclusive limited warranty of Seller. This LIMITATION OF WARRANTY AND LIABILITY may not be amended, modified or its terms waived, except by writing signed by an Officer of Seller.

### **Service Policy**

Knowing that inoperative or defective instruments are as detrimental to TSI as they are to our customers, our service policy is designed to give prompt attention to any problems. If any malfunction is discovered, please contact your nearest sales office or representative, or call TSI's Customer Service department at 1-800-874-2811 (USA) or (651) 490-2811.

### **Trademarks**

TSI<sup>®</sup>, TSI logo, Alnor<sup>®</sup>, and Balometer<sup>®</sup> are registered trademarks of TSI Incorporated.

# START SEEING THE BENEFITS OF REGISTERING TODAY!

---

Thank you for your TSI instrument purchase. Occasionally, TSI releases information on software updates, product enhancements and new products. By registering your instrument, TSI will be able to send this important information to you.

**<http://register.tsi.com>**

As part of the registration process, you will be asked for your comments on TSI products and services. TSI's customer feedback program gives customers like you a way to tell us how we are doing.



UNDERSTANDING, ACCELERATED

**TSI Incorporated** - Visit our website **[www.tsi.com](http://www.tsi.com)** for more information.

<b>USA</b>	<b>Tel:</b> +1 800 874 2811	<b>India</b>	<b>Tel:</b> +91 80 67877200
<b>UK</b>	<b>Tel:</b> +44 149 4 459200	<b>China</b>	<b>Tel:</b> +86 10 8219 7688
<b>France</b>	<b>Tel:</b> +33 1 41 19 21 99	<b>Singapore</b>	<b>Tel:</b> +65 6595 6388
<b>Germany</b>	<b>Tel:</b> +49 241 523030		

©2015 TSI Incorporated

Printed in U.S.A.



---

## TABLE OF CONTENTS

Section 1	General Description .....	1
Section 2	Theory of Operation .....	1
Section 3	Safety .....	2
Section 4	Instrument Setup and Storage .....	2
Section 5	About the Instrument Display .....	4
Section 6	Getting Started .....	5
Section 7	Detailed Operation .....	5
Section 8	Troubleshooting .....	8
Section 9	Maintenance .....	9
Section 10	Service Information .....	10
Appendix A	Correction Factors for Standard Flow Rate to Actual Flow Rate .....	11
Appendix B	Model 6200 LoFlo Balometer® Capture Hood Field Setting Instruction for User Programmable Correction Factors .....	12



---

## SECTION 1

### General Description

The Alnor® LoFlo Balometer® Capture Hood is a compact instrument that measures very low air flow rates in HVAC systems. It measures from 10 to 500 cfm (17 to 850 m<sup>3</sup>/h, 4.7 to 236 l/s). The LoFlo Balometer® Capture Hood displays standard air volume rate when placed at supply or return diffusers, registers, or grilles located on the ceiling, wall, or floor.

The LoFlo Balometer® Capture Hood has a vent mechanism which reduces the restriction of air flow caused by the instrument. This unique venting system (patent pending) allows the instrument to remain compact while still measuring a wide range

of volume rates. The LoFlo Balometer® Capture Hood should be used with the vents closed at lower volume rates, but higher volume rates should be measured with the vents open to minimize any resistance effects. A 2-point measurement may be taken to compensate for the resistance effect of the instrument at higher volume rates.

The LoFlo Balometer® Capture Hood is battery powered and may be used with or without optional hoods. It weighs just over 6 pounds with the 2' x 2' hood, helping to reduce worker fatigue.

---

## SECTION 2

### Theory of Operation: Capture Hoods and Thermo-anemometry Sensing

As air exits a diffuser, it is captured in the hood or base and directed over a manifold. The manifold averages the velocity pressure and directs air over the sensors. The velocity and temperature of the air passing through the manifold are sensed, using a constant temperature thermo-anemometer principle. The voltage output from the sensor is then calibrated for the entire volume rate passing through the LoFlo Balometer® Capture Hood.

All capture hoods are susceptible to “odd” air flow patterns. “Odd” could refer to any air flow pattern different from the pattern where it was calibrated. Substantial negative effects can be observed when using a large hood on a small diffuser. For

example, using a 2' x 2' hood on a 10" x 10" diffuser. This creates large recirculation regions on the sides of the fabric hood and causes an “odd” air flow pattern as it passes over the manifold. It is recommended to match the hood closely to the size of the diffuser.

➔ **NOTE:** *Throughout this manual, the units cfm, m<sup>3</sup>/h and l/s are used for simplicity. Note, however, that the LoFlo Balometer® Capture Hood actually reads in standard cubic feet per minute (scfm), standard cubic meters per hour (std. m<sup>3</sup>/h), or standard liters per second (std. l/s).*

---

## SECTION 3

### Safety

When using the LoFlo Balometer® Capture Hood to check air flow at ceiling diffusers, make certain that you can safely raise and hold the unit while making measurements. Be especially careful when working on a ladder.

Observe all necessary precautions so that the unit does not become caught in moving machinery or touch any exposed electrical wiring.

The LoFlo Balometer® Capture Hood is not designed for gas mixtures other than air. Use with corrosive or other dangerous or explosive gas mixtures is not recommended and is at the user's risk.

	<b>CAUTION</b>
	WHILE USING THE LOFLO BALOMETER® INSTRUMENT TO TEST AIR FLOW IN DUCTS, YOU MAY COME INTO CONTACT WITH OR BE EXPOSED TO DUST, POLLEN, MOLD, FUNGUS, OR OTHER AIRBORNE CONTAMINANTS. IF YOU ARE OR MAY BE SENSITIVE TO DUST, POLLEN, MOLD, FUNGUS, OR OTHER AIRBORNE CONTAMINANTS, <b>ALWAYS</b> USE AN APPROPRIATE MASK OR RESPIRATOR WHILE EMPLOYING THE LOFLO BALOMETER® INSTRUMENT.

---

## SECTION 4

### Instrument Setup and Storage

#### Hood Setup

1. Locate the four (4) aluminum channels for the hood and position them into a square with the foam facing up. Slide the "U" opening on the channel end (Fig. 1) and corner bracket toward the brass eyelets until you feel it latch.
2. Continue with the other two channels until you have a square frame that is locked tightly in all four corners.
3. Locate the hood for the frame size you have assembled.
4. Position a corner seam of the hood onto the corner of the frame. Stretch the nylon hood to an adjacent corner until the hood corner meets the frame corner.
5. Push the elastic cord into the channel along the side of the frame.
6. Repeat steps 4 and 5 until the hood assembly is complete and ready to mount onto the base.
7. Place hood on a table or clean floor with the base inside the opening. Pull the hood over

the base. Rotate the hood assembly until the metal cups are above the spring-loaded pins.

8. Locate the hood support rods. Extend the hood so it is taut and insert one support rod onto the spring-loaded pin closest to you.
9. Push the support rod down and insert the top end of the rod into the metal cup on the hood frame. Fig 1.
10. Install the rod on the opposite side then install the last two rods.

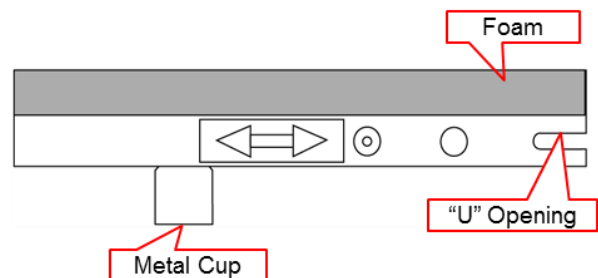

**Figure 1**  
**Hood Frame Channel**



## **Instrument Storage**

The hood and frame assemblies can be detached from the instrument base and placed inside their own carrying case without disassembly.

The LoFlo Balometer® Capture Hood should always be turned off before re-packing the instrument. If storing the LoFlo Balometer® Capture Hood for an extended period of time, remove the batteries to prevent damage due to leakage.

## **Battery Installation**

To install the 4 C-size batteries that ship with the LoFlo Balometer® Capture Hood:

1. Make sure the LoFlo Balometer® Capture Hood switch is off.
2. Remove the battery cover located on top of the meter.
3. Slide the battery holder up until the snap connector is exposed.
4. Disconnect the battery holder from the LoFlo Balometer® Capture Hood.
5. Install the 4 C size batteries in the holder.
6. Reconnect the snap connector and slide the battery holder into the battery compartment.
7. Replace battery cover.

## SECTION 5

### About the Instrument Display

This display is an analog display, simulated with 26 LCD segments to give the user the response of a mechanical Balometer® Capture Hood. It also displays an exact digital number, using 3½ digit numeric section. The LCD has indicators for supply, return, manual range, vent modes, and low battery.

Figure 3 shows the front of the LoFlo Balometer® Capture Hood.

Index No.	Name
1	LCD
2	On/Off Switch
3	Supply/Return Button
4	Manual Range Button
5	Handle Button
6	Battery Holder
7	Vents
8	Vent Open/Close Slide

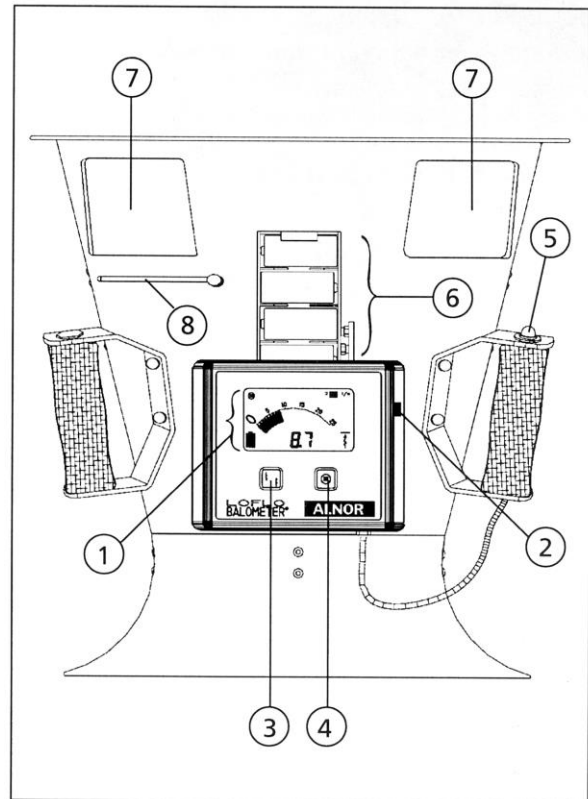

**Figure 3**  
Front View of LoFlo Balometer® Capture Hood

Figure 4 shows the LCD.

Index No.	Name
1	Digital Readout
2	Simulated Analog Display
3	Manual Range Indicator
4	Supply/Return Indicator
5	2-Point Mode Indicator
6	Vent Indicator
7	Units Indicator
8	Low Battery Indicator

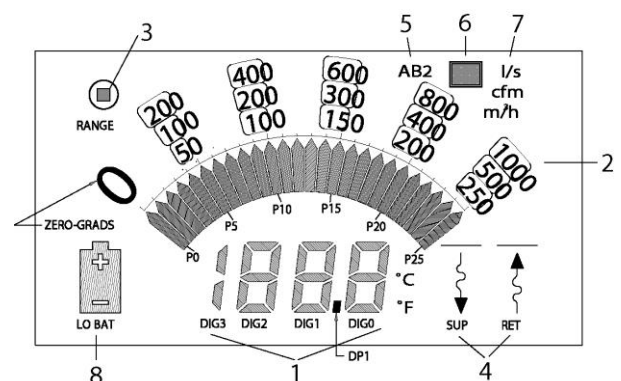

**Figure 4**  
LoFlo Balometer® Capture Hood LCD

---

## SECTION 6

### Getting Started

- ➔ **NOTE:** *The instrument should be allowed to stabilize to room conditions in order to achieve specified accuracy.*
1. If you are using a hood with the unit, assemble the LoFlo Balometer<sup>®</sup> Capture Hood as described in Section 4, "[Instrument Setup and Storage](#)."
  2. Turn on the unit using the slide switch located on the right side of the meter.
  3. When turned on, the LoFlo Balometer<sup>®</sup> Capture Hood displays the vent closed indicator. Close the vent on the base by turning the top baffle counter clockwise.
  4. Select the proper mode for air flow direction, supply or return.
  5. Place the LoFlo Balometer<sup>®</sup> Capture Hood over the diffuser or grille to be measured.
  6. The auto range feature of the LoFlo Balometer<sup>®</sup> Capture Hood will choose the correct scale and display the volume rate in the digital readout section. A quick press on the handle switch will freeze the display.
  7. Another quick press will unfreeze the display.
  8. For volume rates above 150 cfm (255 m<sup>3</sup>/h, 71 l/s), it is recommended to use the vent open mode to minimize air flow resistance effects. See Section 7, "[Detailed Operation](#)."
- ➔ **NOTE:** *Make sure that there are no gaps between the LoFlo Balometer<sup>®</sup> Capture Hood and the surface around the diffuser or grille. Also, make sure that your body or other objects are not blocking or diverting the air flow where the air is exiting (supply) or entering (return). This will affect the reading.*
- 

## SECTION 7

### Detailed Operation

#### Handle Button

In 1-point mode, the handle button will freeze the digital reading and flash the value when it is pressed for less than three seconds. When the handle button is pressed for more than three seconds, it switches the LoFlo Balometer<sup>®</sup> Capture Hood between vent closed mode and vent open mode.

In 2-point mode, the handle button cycles the instrument through the 2-point measurement process. See 2-point mode section for detail.

#### Auto/Manual Ranging Button



When turned on, the instrument is in auto-range mode. The user can switch to manual range mode by pressing the range button. The manual range indicator will show. By pressing the range button, the meter display switches to the next volume range. To return to auto-range mode, press and hold the range switch until the manual range indicator disappears.

#### Changing Measurement Units

To change measurement units:

1. Turn the instrument off.
2. Press and hold the supply/return button and switch the instrument on at the same time.
3. The display will flash one of the three available measurement units: cfm, m<sup>3</sup>/h, l/s.
4. Press and hold the supply/return button or the range button to scroll through the measurement units.
5. When the units you desire are displayed, switch the instrument off.
6. When you turn the instrument on again, your chosen units will be displayed.

## Supply/Return Button

The LoFlo Balometer® Capture Hood is in supply mode when turned on. This is indicated on the display with the supply indicator . To take return air measurements, press the supply/return button on the front of the meter. Return air mode will be indicated on the display with the return indicator .



Significant errors may result if:

- Instrument is not in proper mode.
- Fabric hood is not used with vent open mode.

## Vent Closed/Vent Open Modes

When the instrument is turned on, it is in the vent closed mode . When the vent closed indicator is on, the vents must be closed to take the measurement. Close the vents by loosening the thumbscrew and sliding the vent baffle to the fully closed position and locking the vent in place again.

The vent open mode is indicated with the vent open indicator on the LCD . Open the vents by loosening the thumb screw and sliding the vent baffle to the fully open position and locking it into place again. Then press and hold the handle switch for more than 3 seconds to switch the LoFlo Balometer® Capture Hood to the open vent mode.

The vent open mode was developed for higher volume rates on larger diffusers; the 2' x 2' or 650 mm x 650 mm hood should always be used with vent open mode.

## 1-Point Measurement Mode

The default mode of the LoFlo Balometer® Capture Hood is the 1-point measurement mode. If you are in 2-point measurement mode, simply turn the instrument off and turn back on.

The 1-point measurement mode is described in the [Getting Started](#) section earlier in this manual. This is the faster, simpler way to take measurements.

Use Vent Closed Mode for measurements between:

10 to 150 cfm (17 to 255 m<sup>3</sup>/h, 4.7 to 71 l/s).

➔ **NOTE:** *In Vent Closed Mode, volume rates below 8 cfm (13 m<sup>3</sup>/h, 3.6 l/s) are displayed as 0; volume rates above 517 cfm (879 m<sup>3</sup>/hr, 244 l/s) are displayed as Or.*

Use Vent Open Mode for measurements between:

150 to 500 cfm (255 to 850 m<sup>3</sup>/h, 71 to 236 l/s)

➔ **NOTE:** *In Vent Open Mode, volume rates below 150 cfm (255 m<sup>3</sup>/h, 71 l/s) are displayed as Ur; volume rates above 517 cfm (879 m<sup>3</sup>/h, 244 l/s) are displayed as Or.*

## 2-Point Measurement Mode—Supply Only

To activate the 2-point measurement mode, turn the instrument off. While pressing the handle button, turn the instrument back on. The 2-point mode indicator will show.

The 2-point measurement mode takes both vent open and vent closed measurements to calculate a resistance-compensated volume flow rate.

The process starts with the vents closed and the display showing the vent closed indicator.

1. Place the LoFlo Balometer® Capture Hood over the diffuser to be measured and press the handle switch once to take the vent closed measurement.
2. The instrument stores that reading.
3. The display will now show the open vent indicator and you should open the vents.

➔ **NOTE:** *Make certain you are using a fabric hood when in 2-point mode.*

4. Again place the LoFlo Balometer® Capture Hood over the diffuser to be measured and press the handle switch to take the vent open measurement.
5. The instrument calculates and displays the compensated reading.
6. The numeric display will flash; press the handle switch again and the instrument will display the vent closed indicator. Close the vents.
7. Return to Step 1 to take another resistance compensated reading.

➔ **NOTE:** *Return to 1-point measurement mode at any time by turning the power off and on.*

When “—” is displayed at the last step of the 2-point mode, the calculation for the resistance effect cannot be made. It can be caused by any of the conditions listed here.

Condition	Reason
The vent closed or vent open measurement is less than 150 cfm (70 l/s, 255 m <sup>3</sup> /h).	<ul style="list-style-type: none"> <li>Calculations are not made at the low end since the effect is small and can generally be neglected. Use 1-point mode.</li> </ul>
The vent closed or vent open measurement is greater than 500 cfm (235 l/s, 850 m <sup>3</sup> /h).	<ul style="list-style-type: none"> <li>Calculations are not made beyond the calibrated range.</li> </ul>
The vent open measurement minus the vent closed measurement is too small (< 0).	<ul style="list-style-type: none"> <li>A mistake has occurred in the process. Repeat the two-point measurement.</li> <li>The resistance effect is small and was overwhelmed by natural fluctuations. Use single-point mode.</li> </ul>
The vent open measurement minus the vent closed measurement is too large.	<ul style="list-style-type: none"> <li>A mistake has occurred in the process. The vent may not have been open for the open vent measurement. Repeat the two-point measurement.</li> <li>The effect is beyond the range of the compensation equation. Perform a traverse of the system instead.</li> </ul>

➔ **NOTE:** The display will also show “—” when the return mode is selected. The 2-point measurement mode is for supply only.

## SECTION 8

### Troubleshooting

Symptom	Possible Cause and Corrective Action
Meter does not turn on.	<ul style="list-style-type: none"> <li>• Battery holder snap connector not connected. Connect battery holder to instrument.</li> <li>• Batteries may be discharged. Charge or replace them.</li> <li>• Switch failure, wiring failure, or circuit failure. Call TSI.</li> </ul>
Meter reading lower than expected.	<ul style="list-style-type: none"> <li>• Wrong vent mode chosen. Choose correct vent mode, open or closed.</li> <li>• Wrong air direction mode chosen. Choose correct direction, supply or return.</li> <li>• Back pressure effects could be significant. Use 2-point measurement mode.</li> <li>• Hood frame not sealing properly around diffuser or grill. Press hood evenly against diffuser.</li> <li>• Odd air flow pattern present. Perform traverse and use proportional balancing.</li> <li>• Hood torn. Replace, or repair tear with duct tape or other non-porous material.</li> <li>• Meter out of calibration. Call TSI.</li> <li>• Damage to manifold. Call TSI.</li> </ul>
Meter reading higher than expected.	<ul style="list-style-type: none"> <li>• Wrong vent mode chosen. Choose correct vent mode, open or closed.</li> <li>• Wrong air direction mode chosen. Choose correct direction, supply or return.</li> <li>• Odd air flow pattern present. Perform traverse and use proportional balancing.</li> <li>• Meter out of calibration. Call TSI.</li> </ul>
Meter not at zero at zero flow.	<ul style="list-style-type: none"> <li>• Instrument not at room temperature. Allow instrument to acclimate before turning on the power.</li> <li>• The LoFlo Balometer® Capture Hood is reading real room air currents. Place on floor with a piece of cardboard over the top to determine if it is measuring real air currents.</li> <li>• Meter out of calibration. Call TSI.</li> </ul>
Meter displays Er.	<ul style="list-style-type: none"> <li>• Self test failed. Call TSI.</li> </ul>
Handle button not working.	<ul style="list-style-type: none"> <li>• Call TSI.</li> </ul>

---

## SECTION 9

### Maintenance

#### Hoods

Hoods may be cleaned in cool water with a mild detergent.

#### Sensing Manifold

The manifold should be checked visually before using to be certain that the sensing holes have not become clogged with dirt or dust particles. Do **not** immerse the manifold in water. It is recommended that cleaning be done with extreme care with the manifold in place. Do **not** use highly compressed air to clean the manifold tubes.

#### Calibration

It is recommended that your LoFlo Balometer<sup>®</sup> Capture Hood be returned to the factory once a year for a calibration check. When shipping the LoFlo Balometer<sup>®</sup> Capture Hood for factory calibration, pack it carefully, and follow the Instructions for Return in this manual.

#### Vent Operation

If the vent becomes difficult to operate, remove both thumbscrews from the vent mechanism and spray the contacting surfaces with silicone spray lubricant. Wipe off excess and reassemble vent mechanism.

#### Performance Check

If the calibration is to be checked, the best way is to use a reference flow standard more accurate than the LoFlo Balometer<sup>®</sup> Capture Hood. Flow standards that may be used for this purpose include orifice plates, venturis, nozzles, and laminar flow elements. These devices require accurate differential pressure, barometric pressure, and temperature reading instruments to measure either actual or standard volume rate.

If the LoFlo Balometer<sup>®</sup> Capture Hood is checked against a velocity instrument such as a pitot probe/manometer or thermo-anemometer, there may be errors. If a velocity standard is used, the average velocity must be obtained by taking a traverse.\* The accuracy of the traverse is dependent on the flow uniformity, the number of readings taken, the accuracy of the velocity instrument, and operator expertise. This average velocity reading must then be multiplied by the area over which the traverse was taken.

Finally, air flow instrumentation is dependent on environmental conditions such as temperature, atmospheric pressure, humidity, and even turbulence. These conditions can have very different effects on various instrument types. Caution must be exercised when making comparisons.

*\*A traverse is a set of velocity readings taken in a prescribed pattern which will provide an overall velocity value when averaged together. Any of the Alnor velocity measuring instruments can be used for this purpose.*

---

## SECTION 10

### Service Information

#### Service and Repair

Please return your Product Registration Card immediately. This allows us to send you service reminders, special offers, and important information about your product.

Before sending your instrument for calibration or repair, you should call TSI Customer Service. The Service Department will provide you with the cost of service or calibration, Return Material Authorization (RMA) number, and shipping instructions.

Please have the following information available when you call:

- Owner's name, address, and phone number
- Billing address, if different and applicable
- Instrument name or model
- Serial number
- Date of purchase
- Where purchased

TSI recommends that you keep a "calibration log" and keep all records of service on your instrument.

#### Instructions for Return

Send the instrument prepaid. Securely package your instrument in a strong container surrounded by at least two inches (5 cm) of suitable shock-absorbing material. Include the Purchase Order showing instrument model number, cost of service and/or calibration, and the RMA number. Mark the outside of the shipping container with the RMA number. This will expedite processing of your instrument when we receive it.

#### Damaged in Transit

All orders are carefully packed for shipment. On receipt, if the shipping container appears to have been damaged during shipment, the instrument should be thoroughly inspected. The delivering carrier's papers should be signed noting the apparent damage. **DO NOT DISCARD THE BOX.**

If the instrument itself has been damaged, a claim should be promptly filed against the carrier by the customer. The selling agent will assist the customer by supplying all pertinent shipping information; however, the claim must be filed by the insured. If the instrument is damaged beyond use, a new order should be placed with TSI while awaiting reimbursement from the carrier for the damaged instrument.

Call TSI directly for assistance if necessary.



## APPENDIX A

### Correction Factors for Standard Flow Rate to Actual Flow Rate

The LoFlo Balometer® Capture Hood measures standard volumetric flow rate. Standard flow is defined as the flow rate at standard conditions, 70°F (21.1°C) and 14.7 psia (29.92 inHg, 760 mmHg). Actual flow rate is the true volumetric rate of air at the local temperature and barometric pressure. If you desire standard flow rate, use the displayed reading. However, if the actual flow rate is desired, use the information below.

To correct the standard flow rate to actual flow rate use the equation below.

$$V_{act} = V_{std} \times CF$$

$V_{act}$  = Actual flow rate

$V_{std}$  = Standard flow rate (this is displayed by the instrument)

$T_{act}$  = Actual Temperature

$\rho_{act}$  = Actual barometric pressure

$\rho_{std}$  = Standard density 0.075 lb/ft<sup>3</sup>  
(at 70°F and 14.7 psia)

$\rho_a$  = Actual density in lb/ft<sup>3</sup>

$$CF = \rho_{std} / \rho_a \text{ (Correction Factor)}$$

Using the equations or chart below, you can bypass the full density calculation.

Calculations in imperial units

$$CF = (14.7 / \rho_{act}) * (460 + T_{act}) / 530$$

Where  $\rho_{act}$  is in psia and  $T_{act}$  is in °F

Calculations in imperial units

$$CF = (29.92 / \rho_{act}) * (460 + T_{act}) / 530$$

Where  $\rho_{act}$  is in inHg and  $T_{act}$  is in °F

Calculations in metric units

$$CF = (760 / \rho_{act}) * (273.15 + T_{act}) / 294.25$$

Where  $\rho_{act}$  is in mmHg and  $T_{act}$  is in °C

For your convenience, we have made a chart for determining the correction factor given temperature and pressure.

➤ **NOTE:** The atmospheric pressure as reported by the National Weather Service is corrected to sea level and cannot be used if measurements are not at sea level.

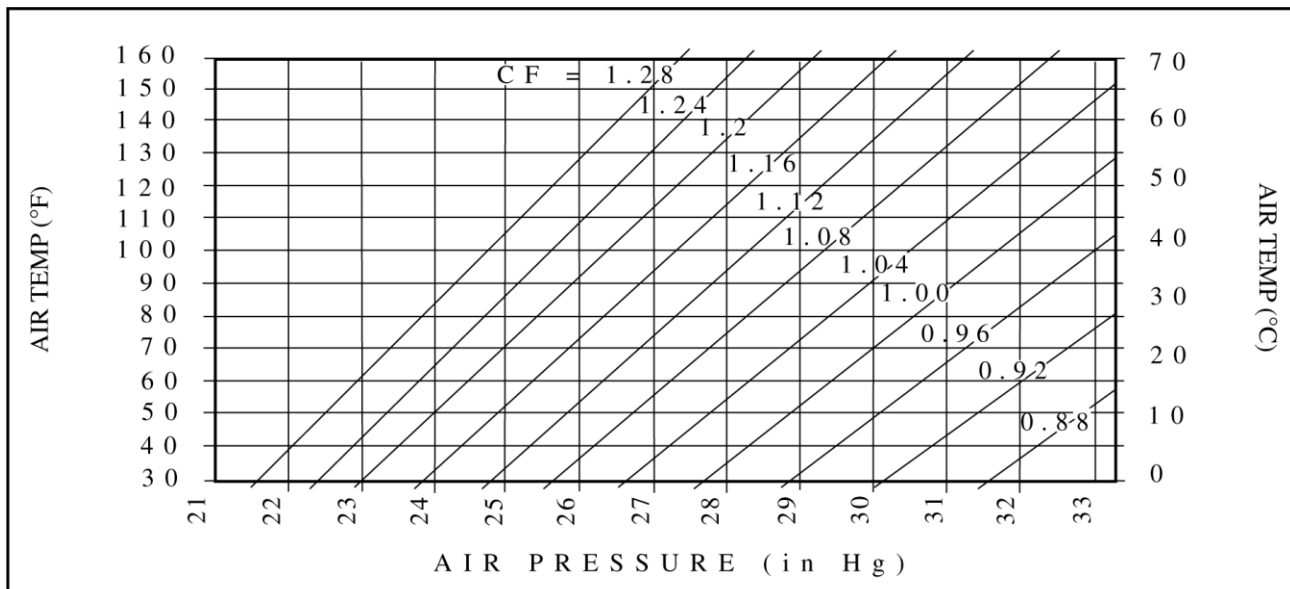

---

## APPENDIX B

### Model 6200 LoFlo Balometer® Capture Hood Field Setting Instructions for User Programmable Correction Factors

#### HISTORY:

It is well known that capture hoods are susceptible to diffuser styles that are different from that upon which they were calibrated. Understanding that these productivity tools may require adjustment in the field, the LoFlo Balometer® Capture Hood is equipped with two separate sets of field programmable correction factors, “**FLD A**” and “**FLD B**”, that allow for a field calibration of the instrument to different diffusers.

#### DETERMINING FIELD PROGRAMMABLE CORRECTION FACTORS:

Correction factors are simply the relation between the actual volume flow rate and that which is displayed on the LoFlo Balometer® Capture Hood. The actual volume flow rate is most accurately established through performing a duct traverse. The correction factor is then determined as the ratio of the actual volume flow rate divided by the volume flow displayed on the LoFlo Balometer® Capture Hood set in the factory calibration setting (default from factory). The number obtained is used as the multiplier for that particular diffuser.

#### Example:

Duct Traverse yields **120 CFM**  
LoFlo Balometer® Capture Hood in Supply Mode  
with Vents Closed yields **107 CFM**  
Correction Factor = **120/107 = 1.121**



Because there are no decimal points available for the correction factor values, this number will be programmed into the LoFlo Balometer® unit as **1121**.

If all available operating modes of the LoFlo instrument are to be used, a separate multiplier must be determined for each mode. The four available modes are:

- Supply, Vent Closed (10-150 CFM)
- Supply, Vent Open (150-500 CFM)
- Return, Vent Closed (10-150 CFM)
- Return, Vent Open (150-500 CFM)

#### PROGRAMMING THE CORRECTION FACTORS TO THE INSTRUMENT:

Once the multipliers have been determined, the correction factors are programmed to the LoFlo instrument using the following steps:

1. Turn the instrument off.
2. Press and hold the range selector button  while simultaneously switching the instrument on. The display will show “**FAC**” with the seven segment characters, indicating the unit is in its default factory setting.
3. Use the supply/return button  to cycle through the available storage fields, “**FLD A**”, “**FLD B**” or “**FAC**”. Use the handle hold switch to select the desired field. If “**FLD A**” or “**FLD B**” are selected, the field letter chosen will be displayed at the upper right of the LCD throughout the programming cycle. **Note that the factory calibration setting, “FAC”, cannot be altered.**
4. Once the desired storage field has been selected, the unit will display the symbols for the Supply, Vent Closed mode, along with the current correction factor programmed for that mode. The factory default coefficient for each mode within both of the programmable storage fields is **1000** (recall that decimal points are not available, and thus the stored value of **1000** is actually **1.000**). Use the supply/return button to increase the coefficients value, or the range selector button to decrease the value as desired. When the correct multiplier is displayed, press the handle hold switch to store the value. The display will then cycle to the Supply, Vent Open mode (indicated by the appropriate symbols), again allowing for increasing/decreasing of the multiplier to the desired set-point as described above. This process will repeat for the remaining two operating modes (Return, Vent Closed; and Return, Vent Open).

5. Once a correction factor has been selected and stored for each of the four operating modes, the unit will proceed into operation using the programmed coefficients of the storage field that was selected. Once again, use of "**FLD A**" or "**FLD B**" will be indicated by the field letter chosen being displayed at the upper right of the LCD throughout the operating cycle. The selected storage field will remain as the start-up default setting unless changed by the user.
6. To return to the factory calibration setting, "**FAC**", press and hold the range selector button while simultaneously switching the instrument on. Select the "**FAC**" setting by depressing the handle hold switch. The factory calibration has just been restored as the default operating setting. Stored coefficients in "**FLD A**" and "**FLD B**" will remain for future use.

**NOTES:**

- Always use the factory calibration setting, "**FAC**", in determining the correction factors.
- Correction factors must be in the range of 0.250 to 1.999 (0250 to 1999 without the decimal point).
- Use of correction factors greater than 1.000 may cause the display to indicate a flow value at zero flow (typically 12-13 CFM at zero flow). This is normal and will limit the use of correction factors at the extreme low-end of the operating range.
- Do not use measurements which are less than 10 CFM \* correction factor. For example, if you program a correction factor of 1.5, do not use measurements less than 15 CFM ( $10 * 1.5 = 15$ ).

*(This page intentionally left blank)*

---

## LOFLO BALOMETER®

### Specifications\*

Range:	10–500 cfm (17–850 m <sup>3</sup> /h) (4.7–236 l/s)	Display:	3.5 digit, .44 in. (11 mm) high, digital display with 26 segment simulated analog display
Accuracy:	±(3% + 5 cfm) [±(3% + 8,5 m <sup>3</sup> /h, 2,4 l/s)]	Resolution	1 cfm from 10–500 cfm (Supply or 0.1 l/s from 4.7 to 9.9 Return) 1 l/s from 10 to 236 l/s
Height:	15.5 in., base only (394 mm) 22 in., with 16 x 16 hood (559 mm) 34.5 in., with 2 x 2 hood (876 mm)	Power Source:	4C 1.5V alkaline batteries (optional Nickel Cadmium)
Weight:	about 6 lbs (2.7 kg) with hood 4.6 lbs (2.1 kg) base only	Battery Life:	10 hrs. minimum with continuous use
Base Diameter Opening:	13.3 in. diameter (338 mm)		
Hood sizes:	16 x 16 in., 2 x 2 ft., or 26 x 26 in. (406 x 406 mm, 610 x 610 mm, or 650 x 650 mm)		

\*Specifications subject to change without notice.



**Alnor Products, TSI Incorporated**

Visit our website [www.alnor.com](http://www.alnor.com) for more information.

**USA**      **Tel:** +1 800 874 2811  
**India**     **Tel:** +91 80 67877200

**China**    **Tel:** +86 10 8219 7688  
**Singapore** **Tel:** +65 6595 6388

P/N 116-620-001 Rev. 09

©1998–2016 TSI Incorporated

Printed in U.S.A.

