

# GL100-N/GL100-WL

**PetitLOGGER**

## USER'S MANUAL

MANUAL NO.GL100-UM-151

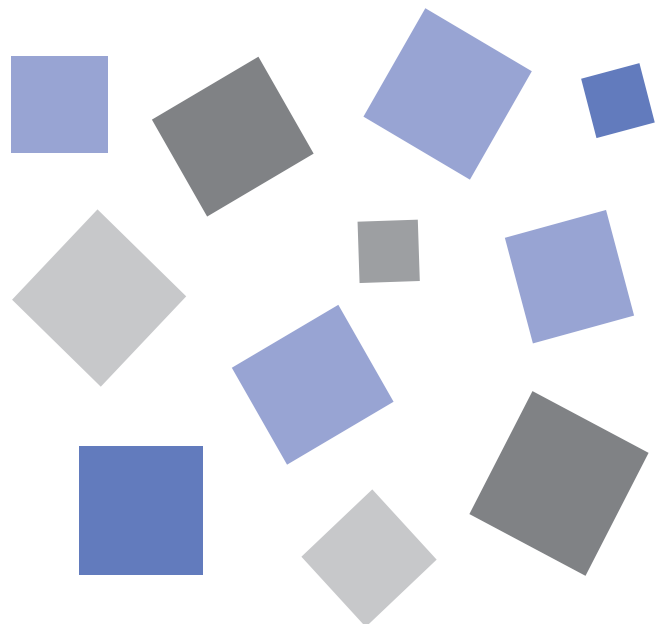

# GRAPHTEC



## To Ensure Safe and Correct Use

- To ensure safe and correct use of the GL100, read this Manual thoroughly before use.
- After having read this Manual, keep it in a handy location for quick reference as needed.
- Do not permit small children to touch the GL100.
- The following describes important points for safe operation. Please be sure to observe them strictly.

### Conventions Used in This Manual

To promote safe and accurate use of the GL100 as well as to prevent human injury and property damage, safety precautions provided in this manual are ranked into the five categories described below. Be sure you understand the difference between each of the categories.



#### **DANGER**

This category provides information that, if ignored, is highly likely to cause fatal or serious injury to the operator.



#### **WARNING**

This category provides information that, if ignored, is likely to cause fatal or serious injury to the operator.



#### **CAUTION**

This category provides information that, if ignored, could cause physical damage to the GL100.



#### **HIGH TEMPERATURE**

This category provides information that, if ignored, is likely to cause burns or other injury to the operator due to contact with high temperature.





#### **ELECTRICAL SHOCK**



This category provides information that, if ignored, is likely to expose the operator to electrical shock.

### Description of Safety Symbols





The  symbol indicates information that requires careful attention (which includes warnings). The point requiring attention is described by an illustration or text within or next to the  symbol.



The  symbol indicates action that is prohibited. Such prohibited action is described by an illustration or text within or next to the  symbol.



The  symbol indicates action that must be performed. Such imperative action is described by an illustration or text within or next to the  symbol.

## Safety Precautions

### ! WARNING

**In the event of a malfunction, remove the batteries and do not attempt to use the device.**

- Attempting to use the device when malfunctioning may cause an electrical shock or fire. Remove the batteries immediately and request repairs.

**Do not use the device in the event that it is producing smoke, is unusually hot, is producing an unusual smell, or other similar circumstances.**

- Attempting to use the device when malfunctioning may cause an electrical shock or fire. Immediately move the device to a non-flammable location and, after confirming it is safe, remove the batteries and request for repairs.



Use prohibited

**Do not use the device for unintended purposes.**

- Do not use the device for uses other than measuring.

**Do not insert foreign objects into the device.**

- Inserting metallic objects or flammable objects into the device may cause an electrical shock or fire.

**Keep away from children.**

- Do not setup the device in a place within the measuring location that children can reach. They may swallow the device and/or injure themselves.

**Do not use the device if it is damaged.**

- This can cause an electrical shock or fire hazard.



Use prohibited

**Do not allow the device to get wet.**

- This can cause an electrical shock or fire hazard. Be especially careful when using the device near windows during rain or snow or in coastal areas.



Avoid water

**Never disassemble or remodel the GL100.**

- Modifying this GL100 may cause an electrical shock or fire due to short circuiting and generating heat.



No disassembly

**If fluid or foreign matters enters inside the GL100, turn off the Power switch and disconnect the power cord from the electrical socket.**

- Use in such status may cause a fire hazard due to electrical shock or current leakage.
- Contact your sales representative or nearest Graphtec vendor to request repair.



Use prohibited

**Do not input voltage that exceeds the permissible input voltage range that is specified on the GL100's label.**

- Exceeding the specified voltage input range may cause electrical shock or a fire hazard.



Use prohibited

## Safety Precautions



### Do not put the device in any of the following places when installing it:

- locations in direct contact with oily smoke or steam
- locations with direct sunlight
- locations that experience temperatures outside the operating range
- Putting the device into places like these may cause short circuiting, heat, deformation of the case, electrical shocks, fires and malfunctions.

### Do not use the device in locations with severe mechanical vibration or large amounts of electrical static.

- Such location may impair the GL100's performance.



Use prohibited

### Do not put heavy objects on top of the device nor climb on top of the device.

- Loss of balance may cause falling, which may cause injury or malfunction.

### Do not insert fingers or other foreign objects into connectors or gaps in the device.

- This can cause injury or malfunction.

### Do not clean the logger using a volatile solvent (such as thinner or benzene).

- Cleaning with volatile solvents may impair the GL100's performance. If the GL100 becomes dirty, wipe it with a clean, soft cloth.



Use prohibited

### Use the specified batteries.

- Using the device with other batteries may cause electrical shock or fire hazard.
- The batteries and exterior of the LOGGER may be very hot.



HIGH TEMPERATURE



Strict observance

### Be careful of gradual deterioration over time.

- Vibration and/or gradual deterioration over time may cause battery terminal contacts to not work properly.

### Be careful of static electricity.

- Static electricity may damage the device. To prevent this from happening, touch a different metal object to discharge any built-up static electricity before touching the GL100.



CAUTION

### Do not touch the device with wet hands.

- This can cause an electrical shock or malfunction.



Don't touch with wet hands

### Remove the batteries when the device is not used for long periods.

- Battery leakage may cause malfunction.



Strict observance

## Safety Precautions



### When using the GL100-WL, note the following:

- If you have an implantable pacemaker or implantable defibrillator installed, radio signals from the device may have an effect on the operation of your implantable pacemaker or implantable defibrillator.



Strict observance

### When using the GL100-WL in a medical establishment, note the following rules:

- Please turn off the power of this product in hospital wards.
- Each medical institution has its own usage prohibitions in various areas. Be sure to follow these.



Strict observance

### When using the GL100-WL, note the following:

- Turn off the device in places where wireless radio signal use is restricted, such as on aircrafts and in hospitals. The device can have an effect on electronic devices, medical devices, etc., and may cause malfunctions.



Use prohibited

### When using the GL100-WL, note the following:

- In the event that the device has an effect on automatic electronic devices such as cars or elevators, immediately turn the GL100-WL off.



Use prohibited

**Do not use the device in any way not specified in this instruction manual. There is a danger that protective provisions will have not been put in place.**



Use prohibited

**The module connection terminal is for use only with separately sold sensors and modules. Do not connect any other devices. Doing so may damage the GL100.**



Use prohibited

**This GL100 is not meant for use with lifesaving devices or devices with mission-critical high reliability or high safety requirements (medical devices, aerospace devices, shipping devices, nuclear power devices, etc.). In the event that this GL100 causes injury or property damage when used under these circumstances, the maker assumes absolutely no responsibility and is not liable.**

# Introduction

Thank you for purchasing the GL100 Petit LOGGER.

Please read this manual thoroughly before attempting to use your new product to ensure that you use it correctly and to its full potential.

## Notes on Use

Be sure to read all of the following notes before attempting to use the GL100 Petit LOGGER.

### 1. Note on the CE Marking

The GL100 Petit LOGGER complies with the following standards.

- N 61326-1 (Class A) standard based on the EMC directive (2004/108/EC)
- EN 61010-1:2010 3rd standard based on the LVD directive (2006/95/ EC)
- EN 301 489-17/-1, EN 300 328 standards based on the R&TTE directive (1999/5/EC)

Although the GL100 complies with the above-mentioned standards, be sure to use it correctly in accordance with the instructions and notes provided in this manual.

Moreover, use of the GL100 by incorrect procedures may result in damage to the GL100 or may invalidate its safeguards. Please confirm all of its notes regarding use and other related information to ensure correct use.

### 2. Warning

This is a Class A product according to the EMC directive. In a domestic environment, this product may cause radio interference or may be affected by radio interference to the extent that proper measurement cannot be performed.

### 3. Notes on Radio Law

This GL100-WL contains a wireless module that Radio Law certified. Make sure to note the following points:

- Do not remove the technical standards compliance label. Do not use the device if it does not have a label on it.
- This GL100 uses the 2.4GHz frequency band.

The following devices and transmitters use the same frequencies and should not be used near this GL100:

- Microwave ovens
- Pacemakers and other industrial, science, and medical devices
- Radio transmitters used in mobile body identification devices on factory production lines, etc. (transmitters requiring licensing)
- Specified low-power radio transmitters (transmitters not requiring licensing) Communications may become slower or impossible due to radio interference.
- The signal may be weak or communications may become slower or impossible depending on the circumstances this GL100 is used in. Take particular note of steel-reinforced, metal, concrete, and other structural materials that can inhibit radio waves.

- This GL100 is meant for use in Japan, the US, and Europe. It has not been certified for use under any other country's radio laws.

The following are each region's certification marks.

Japan



US

Contains FCC ID:YOPGS1011MIPS

Canada

Contains IC ID:9154A-GS1011MIPS

Europe.....CE Mark

#### 4. Notes for Safe Operation

- (1) When connected to high-voltage signal through an analogue signal from 4ch voltage / temperature terminal (GS-4VT), do not touch the central line of the input terminal's signal line.  
There is a risk of electric shock due to high voltage.

#### 5. Notes on Functions and Performance

- (1) Use AA alkaline batteries. Using other types of batteries may cause damage to the device.
- (2) Using the module, sensor, etc. with the vent hole covered may result in inaccurate measurements.
- (3) Using this GL100 in the following environments may cause inaccurate measurements or damage:
  - Places with high temperatures or high humidity, such as direct sunlight and heaters.

Allowable emperature range: -10 to 50°C, allowable humidity range: 0 to 80% RH, non-condensing

#### **If Condensation Occurs**

Condensation occurs in the form of water droplets on the device surfaces and interior when the GL100 is moved from a cold location to a warm one. Using the GL100 with condensation will cause the GL100 to malfunction. Wait until the condensation has evaporated before turning on the power.

#### **CAUTION**

When Temperature and humidity sensors (GS-TH) and GL100-N/GL100-WL are used at the same time, they should be used in the GL100-N/GL100-WL operating environment.

- Locations subject to excessive salt spray or heavy fumes from corrosive gas or solvents.
  - Excessively dusty locations.
  - Locations subject to strong vibrations or shock.
  - Locations subject to surge voltages and/or electromagnetic interference.
- (4) If the GL100 becomes soiled, wipe it off using a soft, dry cloth. Do not use the organic solvents (such as thinner or benzene).
  - (5) Do not use the GL100 in the vicinity of other devices which are susceptible to electromagnetic interference.



- (6) Measured results may not conform to the stated specifications if the GL100 is used in an environment which is subject to strong electromagnetic interference
- (7) Position the input signal cables as far away as possible from any other cables which are likely to cause electromagnetic interference.
- (8) GS-TH Temperature and Humidity Sensors:
  - Humidity sensors measure the change in dielectric capacity of water adsorption. As a result, humidity from organic materials such as fine particles or exhaust gas may have an effect on the sensor. Use in environments with large quantities of these organic materials may lead to significant measurement inaccuracies.
- (9) GS-CO<sub>2</sub> CO<sub>2</sub> Sensor:
  - Because exhaled CO<sub>2</sub> may have an effect on the sensor readings, do not use the sensor to take measurements near the face. Additionally, should air flow to the sensor be blocked, it will result in inaccurate readings, so be sure to keep vent holes open.
- (10) GS-LXUV Illumination / Ultraviolet Sensor
  - When measuring illumination or ultraviolet light that can have harmful effects on the eyes or skin, be sure to use protective eyewear, shielding, etc.
  - If the sensor becomes dirty it may affect measurements, so wipe it with a soft cloth when it becomes dirty.
  - Take care to avoid cracking the sensor when handling it. If the sensor is damaged or cracked it may affect measurements, so replace the sensor.
- (11) Others
  - The GS-TH temperature and humidity sensor, the GS-CO<sub>2</sub> CO<sub>2</sub> sensor, and the S-LXUV illumination / ultraviolet sensor may gradually deteriorate over time depending on usage circumstances and environment, so we recommend periodically replacing these sensors every year or so.
  - The GL100-N/GL100-WL units meet IP54 standards when the sensor or sensor module is connected and then the connector cover and battery cover are closed.  
Note that you cannot use the GL100-N/GL100WL units with devices that do not meet IP54 standards (except for the 3-axis acceleration sensor) when sensors and sensor modules are located in the same environments.  
Additionally, when there is deterioration or damage to the gasket on the connector cover or battery cover of the GL100-N/GL100-WL, it no longer meets IP54 standards, so be sure to either periodically replace them or have them repaired.
  - If the non-optional device is connected to the GL100-N/GL100-WL's module connection terminal or the GS-DPA branch adapter connector, the GL100-N/GL100-WL or branch adapter may be damaged. Please do not connect it.

### **Notes on the Use of This Manual**

- (1) All rights reserved. No part of this publication may be reproduced, stored in a retrieval system, or transmitted, in any form or by any means, without the prior written permission of Graphtec Corporation.
- (2) The specifications and other information in this manual are subject to change without notice.
- (3) While every effort has been made to supply complete and accurate information about this product, please address any inquiries about unclear information, possible errors, or other comments to your sales representative or nearest Graphtec vendor.
- (4) Notwithstanding the preceding paragraph, Graphtec Corporation assumes no liability for damages resulting from the use of the information contained herein or of the product.

### **About Registered Trademarks**

Microsoft and Windows are registered trademarks or trademarks of Microsoft Corporation in the U.S. and elsewhere.

Other company names and product names included in this manual are registered trademarks or trademarks of their respective companies.

### **Copyright**

All copyrights regarding this manual belong to Graphtec Corporation.

# CONTENTS

To Ensure Safe and Correct Use .....	i
Safety Precautions .....	ii
Introduction .....	I
Notes on Use .....	I
Notes on the Use of This Manual .....	IV
About Registered Trademarks .....	IV
Copyright .....	IV

## CHAPTER 1 General Description

1.1 Overview .....	1-2
1.2 Features .....	1-2
1.3 Operating Environment .....	1-3
Ambient Operating Conditions .....	1-3
Warming-up Before Use .....	1-4
Configuration When in Use .....	1-4
1.4 Explanation of Symbols Used on the Equipment .....	1-5

## CHAPTER 2 Checks and Preparation

2.1 Checking the Outer Casing .....	2-2
2.2 Checking the Accessories .....	2-2
GL100-N/GL100-WL Standard Accessories .....	2-2
2.3 Checking the Optional Accessories .....	2-3
Module .....	2-3
Accessories .....	2-3
2.4 Nomenclature and Functions .....	2-4
GL100-N/GL100-WL .....	2-4
Descriptions of Screen Display .....	2-5
2.5 Various Connections .....	2-6
Module Connection Terminal .....	2-6
microSD .....	2-7
USB I/F .....	2-7
Alarm Output Terminal .....	2-7
2.6 Various Modules .....	2-8
4ch Voltage / Temperature Terminal (GS-4VT): Optional .....	2-8
3-axis Acceleration / Temperature Sensor (GS-3AT): Optional .....	2-11
4ch Thermistor Terminal (GS-4TSR): Optional .....	2-13
Adapter for AC Current Sensor (GS-DPA-AC): Optional .....	2-16
Illumination / Ultraviolet Sensor (GS-LXUV): Optional .....	2-22
CO <sub>2</sub> Sensor (GS-CO2): Optional .....	2-24
Temperature / Humidity Sensor (GS-TH): Optional .....	2-25
Adapter for Branch Adapter (GS-DPA): Optional .....	2-27

**CHAPTER 3 Measure and Set**

3.1	Before Setting Up . . . . .	3-2
3.2	Power-on . . . . .	3-3
3.3	Date/Time Adjustment . . . . .	3-8
3.4	Measurement Procedure . . . . .	3-12
	1. Supply the power . . . . .	3-12
	2. Connect the modules . . . . .	3-12
	3. Set the common items (OTHER-1) . . . . .	3-12
	4. Set the measurement conditions . . . . .	3-15
	5. Start or stop the measurement . . . . .	3-24
	6. How to confirm the recorded data . . . . .	3-26

**CHAPTER 4 Specification**

4.1	Standard Specifications . . . . .	4-2
	GL100-N/GL100-WL . . . . .	4-2
4.2	Standard Specifications (Module) . . . . .	4-4
	4ch Voltage / Temperature Terminal (GS-4VT): Optional . . . . .	4-4
	3-axis Acceleration / Temperature Sensor (GS-3AT): Optional . . . . .	4-6
	4ch Thermistor Terminal (GS-4TSR): Optional . . . . .	4-8
	Adapter for AC Current Sensor (GS-DPA-AC): Optional . . . . .	4-10
	Illumination / Ultraviolet Sensor (GS-LXUV): Optional . . . . .	4-12
	CO <sub>2</sub> Sensor (GS-CO2): Optional . . . . .	4-14
	Temperature / Humidity Sensor (GS-TH): Optional . . . . .	4-16
	GS Branch Adapter(GS-DPA): Optional . . . . .	4-18
4.3	Specifications of Application Software . . . . .	4-20
	GL100-APS . . . . .	4-20
	GL100-Network_Config . . . . .	4-20
	Smart Device Application Software . . . . .	4-20

<b>INDEX . . . . .</b>	<b>I-1</b>
------------------------	------------

# ***CHAPTER 1 General Description***

---

This chapter provides a general description of the GL100 and its features.

## ***Product Summary***

- 1.1 Overview***
- 1.2 Features***
- 1.3 Operating Environment***
- 1.4 Explanation of symbols used on the equipment***

## 1.1 Overview

The GL100 series is a small, light-weight data logger that operates with batteries and/or a USB cable connected to a power source.

You can record continuously for long periods of time depending on the power saving settings.

The GL100 series can be easily set up and be used to measure anywhere due to its reduced body size. You can remotely perform measurements and control the device by using the GL100-WL, the wireless model.

You can also conduct multipurpose measurements by using the various sensors and modules.

## 1.2 Features

- You can use it to measure easily due to its small size.
- The GL100 can record data using its internal memory and/or a microSD card.  
The recorded data can be transferred directly to a computer using a USB cable connection, or transferred wirelessly with the GL100-WL type.
- The GL100 meets IP54 standards for basic water resistance and dustproofing, so it can be used in a wide range of measuring environments.
- The GL100 can use commercial batteries (two AA alkaline batteries) and/or a USB cable connected to a power source.  
However, some of the sensors have power source restrictions.
- The GL100 has an alarm output terminal. When the alarm level has been exceeded after the alarm has been set on the various sensors and modules, a signal will be output while also confirming the alarm with the LED.
- All condition settings and measurement data can be checked on the GL100's LCD.
- A wide range of temperature (-20°C to 85°C) and humidity (0% to 100% R.H.) can be measured at the same time by using the temperature and humidity sensor module (GS-TH).
- The 4ch voltage / temperature terminal sensor module can measure up to 4ch of voltage (20mV to 50V and 1V to 5V) and thermocouples (K and T types). It can also measure 4ch logic/pulse separately at the same time (GS-4VT).
- The 4ch thermistor terminal module can be connected to the appropriate thermistor sensor and measure up to 4ch of temperature (-40°C to 105°C and -40°C to 120°C). It can also measure 4ch logic/pulse separately at the same time (GS-4TSR).
- Acceleration oscillation in three directions (2G, 5G and 10G) can be measured using the 3-axis acceleration / temperature sensor (GS-3AT). Temperature (-10°C to 50°C) can also be measured at the same time with the 3-axis acceleration / temperature sensor's internal temperature sensor.
- Voltage can be measured for single-phase two-wire systems, single-phase three-wire systems, three-phase three-wire systems, etc. by using the AC current sensor adapter and AC current sensor (GS-DPA-AC and GS-AC\*\*A).
- Illumination (0 to 200,000 lx) and ultra violet rays (0 to 30 mW/cm<sup>2</sup>) can be measured at the same time by using the illumination / ultraviolet sensor module (GS-LXUV).
- CO<sub>2</sub> (0 ppm to 9999 ppm) can be measured using the CO<sub>2</sub> sensor (GS-CO2).
- You can connect two sensors from among the GS-TH, GS-CO2, and GS-LXUV and perform a combined measurement by using the branch adapter.

## 1.3 Operating Environment

This section explains the operating environment for the GL100.

### Ambient Operating Conditions

1) Ambient Temperature and Humidity ( Use the GL100 within the following ranges)

- Temperature range: -10 to 50°C
- Humidity range: 20% to 80% RH, non-condensing

When connected to the sensor below and used in the same operating conditions, operating conditions are as listed above.

<Temperature and humidity sensor>

- Temperature range: -20 to 85°C
- Humidity range: 0% to 100% RH

2) Environment (This GL100 is designed for indoor use. Do not use in the following locations.)

- When the GL100 body is simple-waterproof and dustproof to IP54 standards but the sensors and modules attached are not in compliance with the IP54, please do not use in this environment.
- A Location such as being exposed to direct sunlight
- Locations exposed to salty air, corrosive gases, or organic solvents
- Dusty locations
- Locations subject to vibration or impact
- Locations subject to voltage surge or electromagnetic interference such as lightning or electric furnaces

---

#### **CHECKPOINT** If Condensation Occurs

**Condensation occurs in the form of water droplets on the device surfaces and interior when the GL100 is moved from a cold location to a warm one. Using the GL100 with condensation will cause the GL100 to malfunction. Wait until the condensation has evaporated before turning on the power.**

---

3) Installation Category (Overvoltage Category)

- The GL100 belongs to Installation Category II defined in IEC 60664-1.
- Never use the GL100 for Installation Category III or IV.

4) Overvoltage Category

Overvoltage categories as defined by IEC 61010 are as follows:GL100-N/GL100-WL: Overvoltage category I. When connected to a PC/AC adapter: Overvoltage category II

\* Be sure to use either a commercially available AC adapter or a PC (with a IEC 60950-1 certified Limited Power Source USB output) with this GL100.

\* Furthermore, do not use this GL100 with IEC 61010-defined overvoltage category III or IV.

5) Altitude

- This GL100 can be used at altitudes up to 2,000m.

6) Power

- Two alkaline batteries or a USB cable connection (5V, 200 mA or higher) can be used to provide power.

7) Degree of Contamination

- This GL100 is IEC 60664-1-certified for use in up to Contamination Degree 2.

8) Use

- This GL100 is intended for use as industrial equipment.

### Warming-up Before Use

The main module should be allowed to warm up with the power turned on for approximately 30 minutes to ensure that it operates according to the specified performance.

### Configuration When in Use

When using this module, please use it on a flat surface or mounted on a wall using wall-mounting brackets.

< Usage Configuration >

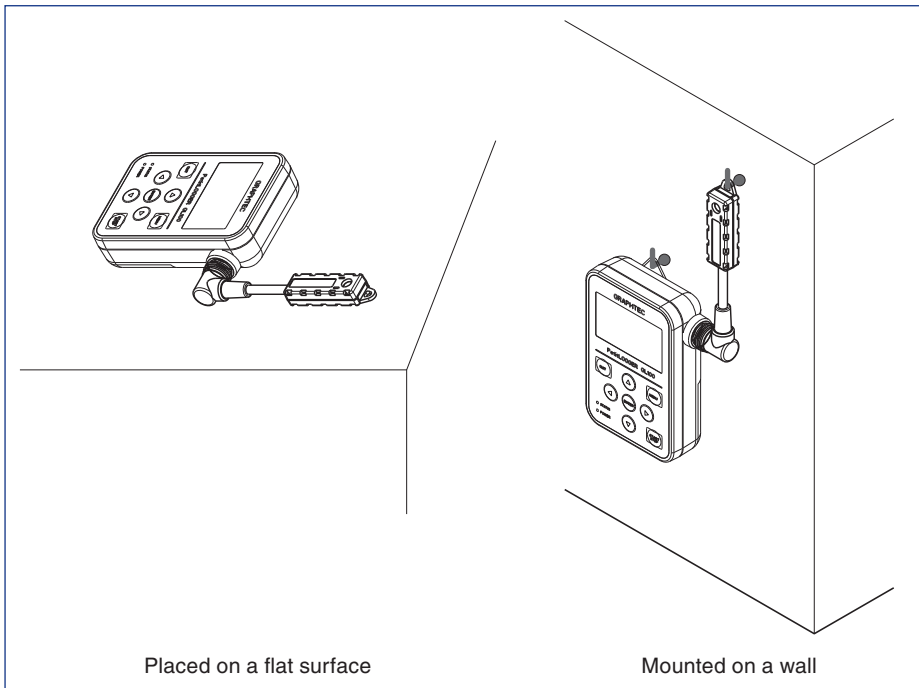



---

**CAUTION** If you use the main module in other position than described in the above, the measurement accuracy may not meet the specifications.

---



## 1.4 Explanation of Symbols Used on the Equipment

Symbols	Meaning	Display locations	Notes
	Caution (Refer to Manual)	<ul style="list-style-type: none"> <li>GL100 Rear Panel Section</li> <li>Module (option) rear panel section</li> </ul>	<ul style="list-style-type: none"> <li>Avoid touching the input terminals and leads of the input terminal's signal cable to prevent electrical shock due to high voltage.</li> <li>If a voltage exceeding the specified value is input, the main unit will be damaged.</li> <li>Install the specified cable to each I/F connector.</li> </ul>
	Earth (Ground) Terminal	<ul style="list-style-type: none"> <li>Module (option) rear panel section</li> </ul>	<ul style="list-style-type: none"> <li>If the measured value is unstable due to the exogenous noise, it is probably better that the cables are thicker between the GND terminal of DUT and the GND terminal of GS-4VT. In addition, the both GND terminals should be connected to the earth for same potential level.</li> <li>If a voltage exceeding the specified value is input, the main unit will be damaged.</li> </ul>

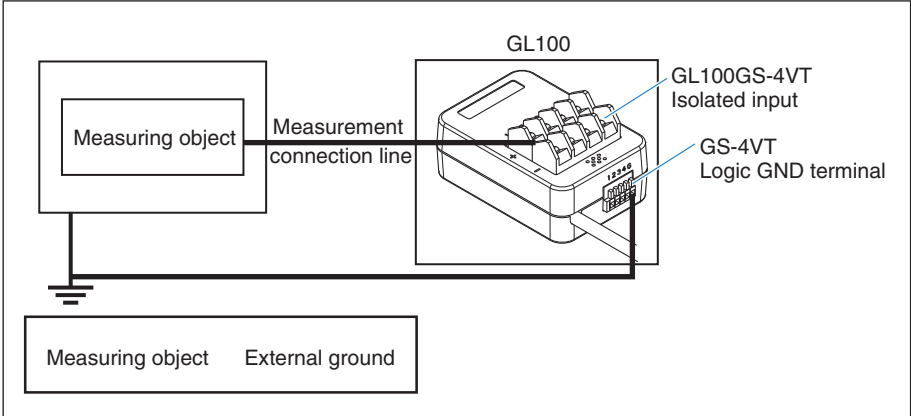

The diagram illustrates the connection setup for the GL100 rear panel. It shows a 'Measuring object' connected to the 'GL100GS-4VT Isolated input' terminal on the GL100 unit. The 'Measuring object' is also connected to an 'External ground' symbol. The GL100 unit also has a 'GS-4VT Logic GND terminal' which is connected to the same ground line.



# ***CHAPTER 2 Checks and Preparation***

---

This chapter explains how to check the main module's external casing and accessories, and how to prepare the main module for operation.

## ***Product Summary***

- 2.1 Checking the Outer Casing***
- 2.2 Checking the Accessories***
- 2.3 Checking the Optional Accessories***
- 2.4 Nomenclature and Functions***
- 2.5 Various Connections***
- 2.6 Modules***

## 2.1 Checking the Outer Casing

After unpacking, check the GL100's outer casing before use. In particular, please check for the following:

- Surface scratches
- Other flaws such as stains or dirt

## 2.2 Checking the Accessories

After unpacking, check that the following standard accessories are included.

- GL100-N : Standard model
- GL100-WL : Wireless LAN model

### GL100-N/GL100-WL Standard Accessories

Item	Description	Quantity
Quick Start Guide	GL100-UM-85x	1
CD-ROM	User's Manual, Application software	1
USB cable	MicroB-A approximate 0.5 m	1

## 2.3 Checking the Optional Accessories

### Module

Item	Model	Description
4ch Voltage / Temperature Terminal	GS-4VT	Terminal for 4ch voltage / temperature measurement (thermocouple only)
3-axis Acceleration / Temperature Sensor	GS-3AT	For 3-axis acceleration and temperature measurement
4ch Thermistor Terminal	GS-4TSR	Terminal for 4ch thermistor temperature measurement (GS thermistor sensor)
Adapter for AC Current Sensor	GS-DPA-AC	Adapter for 2ch AC power measurement (AC current sensor only)
CO <sub>2</sub> Sensor	GS-CO2	CO <sub>2</sub> measurement sensor
Illumination / Ultraviolet Sensor	GS-LXUV	Sensor for 1ch illuminance / 1ch ultraviolet measurement
Temperature / Humidity Sensor	GS-TH	Temperature / Humidity Sensor measurement adapter
Adapter for Branch adapter	GS-DPA	2ch sensor measurement adapter

### Accessories

Item	Model	Description
GS thermistor sensor	GS-103AT-4P	GS-4TSR only (approx. 3 m) Thermistor (-40 to 105°C)
	GS-103JT-4P	GS-4TSR only (approx. 3 m) Ultra-thin shape thermistor (-40 to 120°C)
AC current sensor (50A)	GS-AC50A	GS-DPA-AC-dedicated CT (50A)
AC current sensor (100A)	GS-AC100A	GS-DPA-AC-dedicated CT (100A)
AAC current sensor (200A)	GS-AC200A	GS-DPA-AC-dedicated CT (200A)
GS extension cable	GS-EXC	1.5 m extension cable (between GL100 and sensor, branch adapter and sensor)
Shunt resistance	B-551	250Ω (±0.1%) Rated power of 1 W, Maximum service voltage of 15.8 V, Built to order

## 2.4 Nomenclature and Functions

### GL100-N/GL100-WL

Functions of the GL100-N and GL100-WL (with wireless LAN function) are not same.

Use it after confirming the model name on the rear name plate.

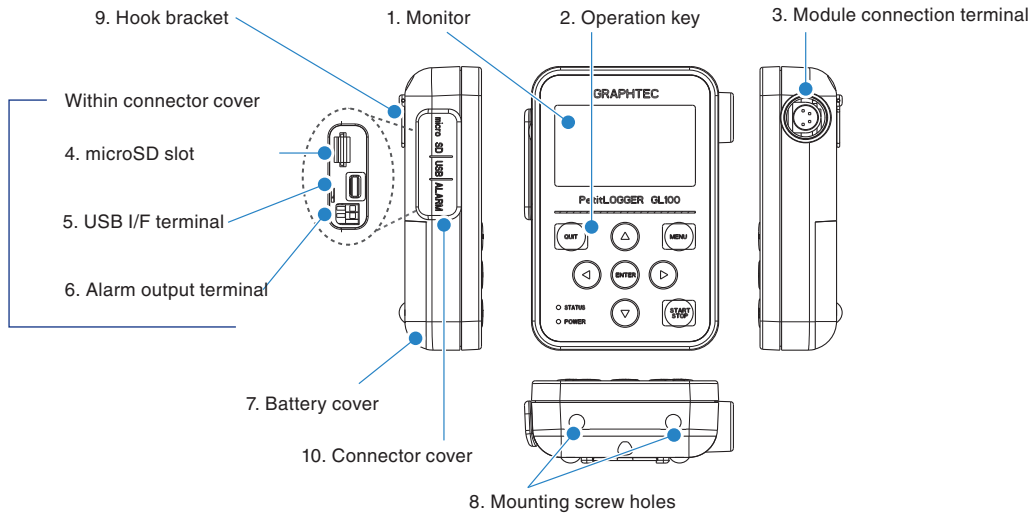

1. Monitor ..... The settings and measured values are displayed.

2. Operation key ..... Key operation is performed on the screen.

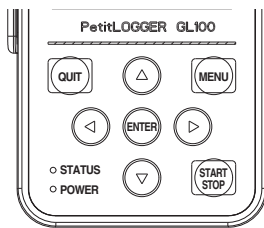

- MENU key : Information about the measurement condition settings and this module is displayed.
- ◀▶ key : Used to select when operating the menu.
- ENTER key : Used to confirm when operating the menu.
- QUIT key : Used to return to the previous screen or display the free-running screen when setting the menu.
- START/STOP key : Used to start/stop the measurement.
- STATUS lamp : The measurement information of this module is displayed in orange.
- POWER lamp : The power supply status is displayed in green.

3. Module connection terminal ..... Used to connect to various measurement module.

4. microSD slot ..... Used to insert microSD card.

5. USB I/F terminal ..... Used to communicate and power supply with USB cable.

6. Alarm output terminal ..... Alarm signal is output from this terminal.

7. Battery cover ..... Two AA alkaline batteries are housed in the battery cover.

8. Mounting screw holes ..... The size of the mounting screw holes is M4 × L5.

9. Hook bracket ..... A metal fixing that suspends and secures the product.

10. Connector cover ..... This is the cover for each connector.

**CAUTION** The module connection terminal is used for the sensor and module sold separately. Do not connect the sensor and module other than them. The GL100 may be damaged.

## Descriptions of Screen Display

### Initial Screen

The following screen is displayed after initializing.

The initial screen shows the following information:

- 1. Data recording status display:** STOP : Recording stopped, ARMED : Awaiting recording start, REC : Recording
- 2. Alarm display:** ALM.
- 3. Current time:** 1 : 28. Note: The current time display can be switched to the elapsed time with the [QUIT] key when recording.
- 8. Measured value display:** +0.01V, +0.10V, +0.50V, +1.00V
- 9. Logic etc. settings display:** L : OFF (repeated for each voltage)
- 7. Sampling interval:** S : 1.0s
- 4. Battery replacement display:** BAT
- 5. LAN:** LAN (displayed when the wireless LAN connection is enabled)
- 6. Displayed only when accessing SD card:** SD

### Descriptions of Setting Screen

Pressing [MENU] key goes to setting menu mode.

The setting screen shows the following information:

- 1. Setting mode display:** [AMP]
- 2. Setting mode page display:** 1 / 10. (e.g. 1/10; page 1 of 10). Press the [MENU] key or use the < and > keys to change the page.
- 3. Settings Display:** Press the  $\Delta$  and  $\nabla$  operation keys to move the cursor. The item the cursor is on can be changed.
- 4. Setting items:** Press the [ENTER] key to display the setting screen for the item with  $\nabla$  displayed (e.g. TEMP  $\nabla$ )

CH	Input	Range
ALL :	TEMP $\nabla$	TC-K $\nabla$
1 :	TEMP $\nabla$	TC-K $\nabla$
2 :	TEMP $\nabla$	TC-K $\nabla$
3 :	TEMP $\nabla$	TC-K $\nabla$
4 :	TEMP $\nabla$	TC-K $\nabla$

## 2.5 Various Connections



<Power-on>: (Refer to 3.2 Power-on.)

- 1) Supply the power.
- 2) The GL100 is ready for operation by holding down [MENU] key.
- 3) Connect the module.

The following screen is displayed. Perform the procedure below.

### Module Connection Terminal

Connect the module (sensor, terminal, and adapter, etc.) sold separately to the module connection terminal.

When the module is not connected, the "Sensor error!!" appears and the setting screen is not displayed. Be sure to connect the module to be used before operating the GL100.



**CAUTION** Please perform the following procedure to replace the module when the power is supplied.

Free-running screen

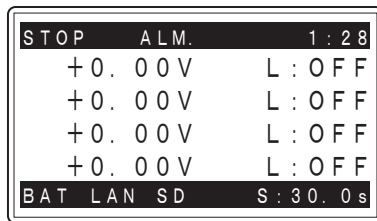

Hold down [QUIT] key to display the "Sleeping!!".

Standby state

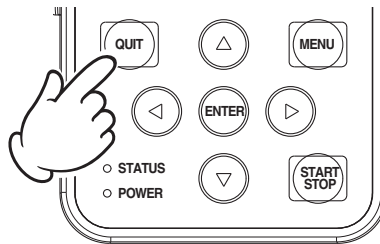

Switches to Power OFF mode.

[QUIT] key

The Power OFF mode is used to save the battery power when the GL100 is not operated. In the Power OFF mode, the battery life is approx. 5 months. When the GL100 is in Power OFF mode (temperature 25°C, new batteries), the GL100 switches to standby state by holding down the [MENU] key.

Even when the "Sleeping!!" is displayed, the module can be replaced.

While the "Initializing" is executed, please do not operate anything.

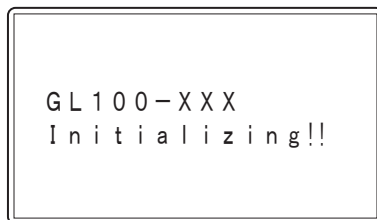



## microSD

To insert or remove the microSD, follow the procedure below.

Gently push the microSD card into the slot until it is locked.

\* Make sure to insert the card the right way.

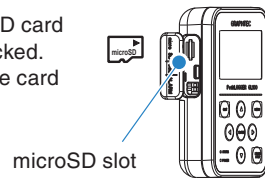

When ejecting the microSD card, push it in gently, then remove the card.

- 
- CAUTION**
- When mounting, the STATUS lamp will turn on while it checks the amount of available space. Please wait until it turns off.
  - When the microSD is inserted, the data free space is checked even in free-running, therefore The SD display and STATUS lamp are lit for a moment.
- 

## USB I/F

The USB I/F is used to supply the external power to the GL100-N/GL100-WL and communicate and control the data. For the power supply capacity, refer to the section “Power Supply Connection”.

## Alarm Output Terminal

Specification: Photo-coupler insulation switching type

Rating: 30V, 50mA (power dissipation 150 mW)

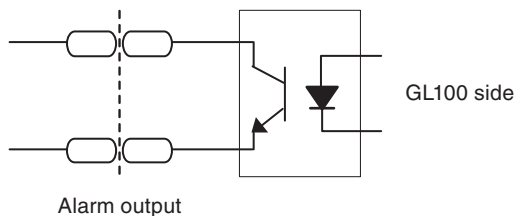

Alarm output

Within connector cover

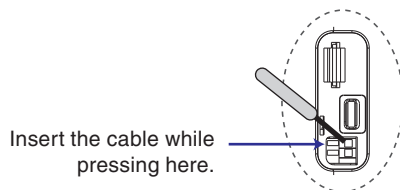

**\*CAUTION**

When pressing here with a flat screwdriver, please press the tip of the driver so as not to be deeper than the connector surface. If the connector is pressed too much, it will be damaged.

## 2.6 Various Modules

### 4ch Voltage / Temperature Terminal (GS-4VT): Optional

This section describes the name and function of each part.

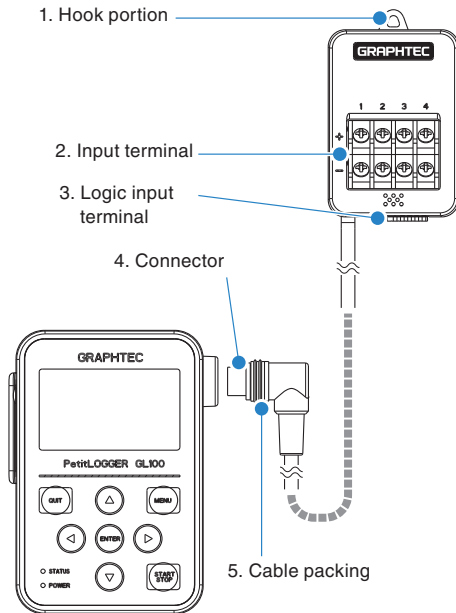

1. Hook portion ..... Used to mount to a wall.
2. Input terminal ..... Used to connect voltage input or thermocouple.
3. Logic input terminal ..... Used to apply logic input.
4. Connector ..... Used to connect to the connector on the GL100 module.
5. Cable packing ..... This packing is used when connecting the connector.

---

**CAUTION** This module is not dustproof or waterproof. Please use it in a proper usage environment.

---



---

**CHECKPOINT** After connecting the GL100 to modules or sensors, please always check/set the time and date.

---



---

**CHECKPOINT** < Extension cable >  
 The module can be used approx. 1.5 m away from the GL100 by using an extension cable for GS (GS-EXC). However, you cannot connect and use multiple extension cables.

---

## Tip of Each Input Terminal Function

### 1. Voltage input

Make sure to pay attention to the + and – terminals when connecting it.

- + ..... High-voltage terminal (terminal input on the input signal's high-voltage side)
- ..... Low-voltage terminal (terminal input on the input signal's low-voltage side)

### 2. Thermocouple input

Connect thermocouple to the + and – terminals.

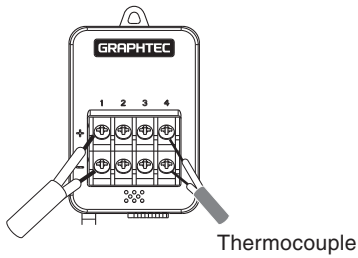

### 3. Current input

Attach shunt resistance when measuring the current input.

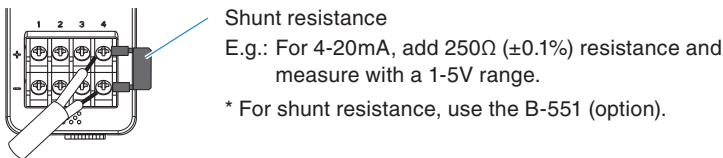

### 4. Logic / pulse input

- + ..... No. 1 to No. 4: High-voltage terminal (terminal input on the input signal's high-voltage side)
- ..... G: Low-voltage terminal (terminal input on the input signal's low-voltage side)

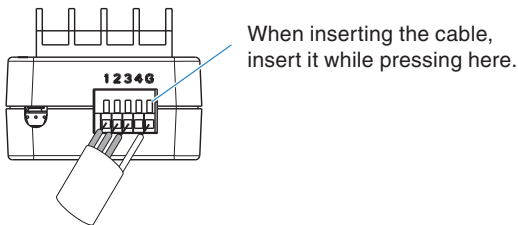

---

**CAUTION** • G is the GND terminal for this module.  
• For the maximum input voltage, refer to “3 Regarding Maximum Input Voltage.”

---

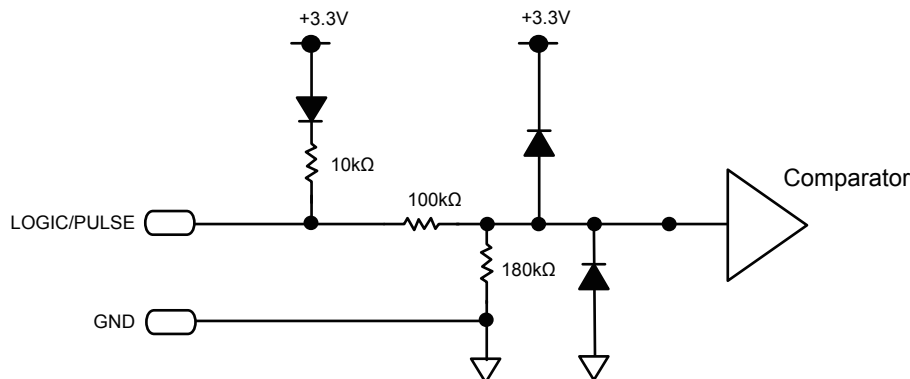

---

**⚠ CAUTION** Notes on temperature measurement

When measuring the temperature, please pay attention to the following.

- Do not block the air vents of the GL100. Leave a clear space of at least 20 cm around it.
  - To measure stably the temperature, please warm up for 30 minutes or more after power-on.
  - When rapid temperature change occurs in the input terminals, the error may occur on the measurement.
  - When the measurement is performed in noisy place, be sure to connect to the ground through the GND terminal.
- 

### Regarding Maximum Input Voltage

To avoid break-downs or short-circuiting accidents, please make sure to abide by the items written below.

In case the input voltage exceeds the specifications, the circuit at the input part will break down. Please don't input it.

<Input terminal (+) / Input terminal (-) interval>

Maximum input voltage: DC60Vp-p

<Input terminal (-) /Input terminal (-) interval>

Maximum input voltage: 60Vp-p

<Input terminal (-) /GND terminal interval>

Maximum input voltage: DC60Vp-p

Withstand voltage: 350Vp-p/1min.

Logic/Pulse

<Input terminal (+) / GND terminal interval>

Maximum input voltage: DC24V

- For the display screen when maximum input voltage is applied, if a voltage exceeding 10% of full scale for the measurement range is input, the “+++++” is displayed for positive direction, or the “- - - -” is displayed for negative direction.

### 3-axis Acceleration / Temperature Sensor (GS-3AT): Optional

This section describes the name and function of each part.

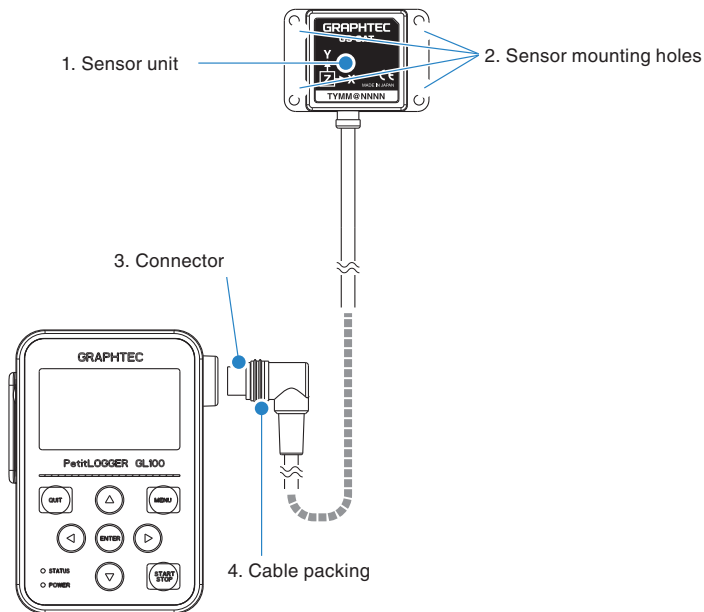

1. Sensor unit ..... The 3-axis acceleration and temperature sensor are built in this module.
2. Sensor mounting hole ..... Used to fix the sensor.
3. Connector ..... Used to connect to the connector on the GL100 module.
4. Cable packing ..... This packing is used when connecting the connector.

---

**CAUTION** This sensor unit is dustproof and splash-resistant to IP54 standards. It can be used in the same conditions as the module. Please take care not to drop or shock the sensor.

---



---

**CHECKPOINT** After connecting the GL100 to modules or sensors, please always check/set the time and date.

---



---

**CHECKPOINT** < Extension cable >  
The module can be used approx. 1.5 m away from the GL100 by using an extension cable for GS (GS-EXC). However, you cannot connect and use multiple extension cables.

---

### Tip of the Sensor Mounting

Check the operating direction of the sensor unit, then securely mount it using four M3 screws to what is to be measured.

#### 1. Connecting to the module

When connecting this module, you can also use the GS extension cable (GS-EXC; sold separately) for more convenient connection.

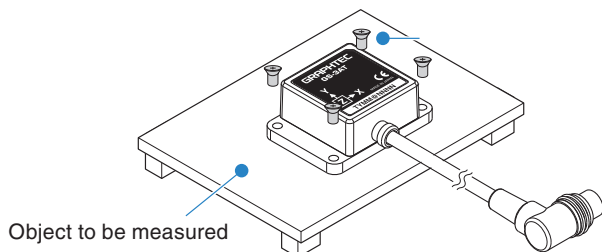



---

**CAUTION** If the sensor's mounting is loose, it will give inaccurate readings.

---

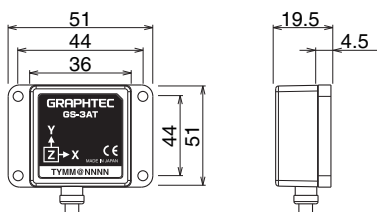
Sensor unit mounting dimensions  
(Unit: approx. mm)



---

### CHECKPOINT

#### < Extension cable >

The module can be used approx. 1.5 m away from the GL100 by using an extension cable for GS (GS-EXC). However, you cannot connect and use multiple extension cables.

---

There are  $\pm 2G$ ,  $\pm 5G$ , and  $\pm 10G$ , or  $\pm 20m/s^2$ ,  $\pm 50m/s^2$ , and  $\pm 100m/s^2$  in the acceleration range.

However, the gravitational acceleration is  $1G = \text{Approx. } 9.807 \text{ m/s}^2$ .

### 4ch Thermistor Terminal (GS-4TSR): Optional

This section describes the name and function of each part.

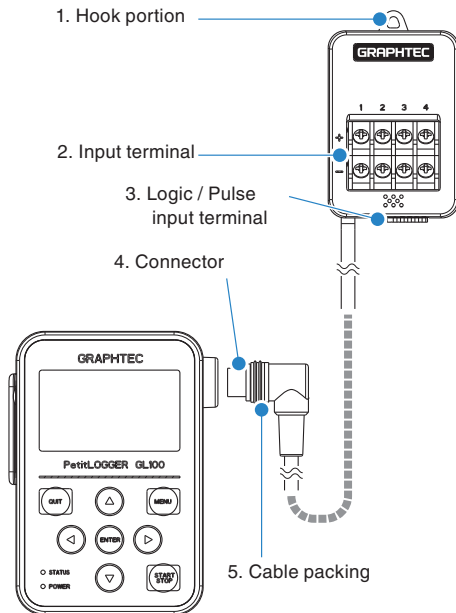

1. Hook portion ..... Used to mount to a wall.
2. Input terminal ..... Used to connect Thermistor.
3. Logic/Pulse  
input terminal ..... Used to input logic / pulse.
4. Connector ..... Used to connect to the connector on the GL100 module.
5. Cable packing ..... This packing is used when connecting the connector.

---

**CAUTION** The GL100 is not waterproof and dustproof. Please use it in a proper usage environment.

---



---

**CHECKPOINT** After connecting the GL100 to modules or sensors, please always check/set the time and date.

---



---

**CHECKPOINT** < Extension cable >  
The module can be used approx. 1.5 m away from the GL100 by using an extension cable for GS (GS-EXC). However, you cannot connect and use multiple extension cables.

---

## Tip of Each Input Terminal Function

### 1. Thermistor input

Connect the GS thermistor sensor (GS-103AT-4P or GS-103JT-4P; each sold separately) to the +/-.

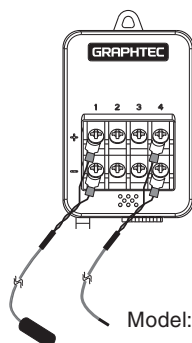

Model: GS-103JT-4P (Ultra-thin shape)

Model: GS-103AT-4P

---

**⚠ WARNING** This terminal is for thermistor input only. Make sure not to input voltage or electric current, as this can cause damage.

---

### 2. Logic / pulse input

Connect GS thermistor sensor (GS-103AT-4P or GS-103JT-4P) sold separately to the + and – terminals.

- + ..... No. 1 to No. 4: High-voltage terminal (terminal input on the input signal's high-voltage side)
- ..... G: Low-voltage terminal (terminal input on the input signal's low-voltage side)

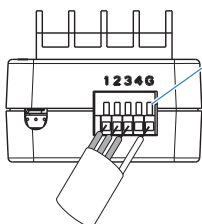

When inserting the cable,  
insert it while pressing here.

---

**⚠ CAUTION** G is the GND terminal for this module.

---



---

**CHECKPOINT** For the circuit configuration, please refer to “Tip of each input terminal function” in “4ch voltage / temperature terminal (GS-4VT)” described above.

---



## Regarding Maximum Input Voltage

To avoid break-downs or short-circuiting accidents, please make sure to abide by the items written below.

In case the input voltage exceeds the specifications, the circuit at the input part will break down. Please don't input it.

Logic / Pulse

<Input terminal (+) / GND terminal interval>

Maximum input voltage: DC24V

## Adapter for AC Current Sensor (GS-DPA-AC): Optional

This section describes the name and function of each part.

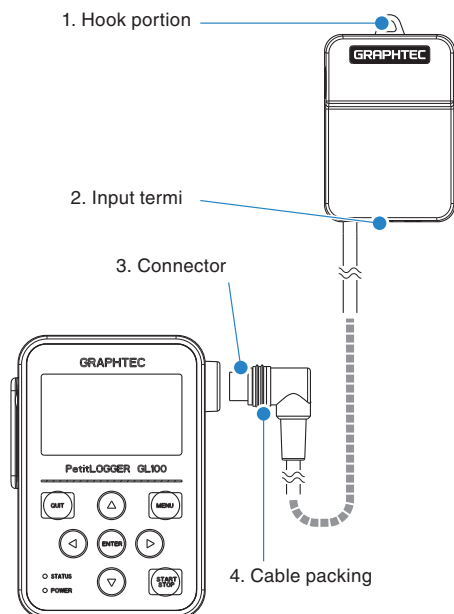

1. Hook portion ..... Used to mount to a wall.
2. Input terminal ..... Terminal that connects to the AC Current Sensor (sold separately).
3. Connector ..... Used to connect to the connector on the GL100 module
4. Cable packing ..... This packing is used when connecting the connector.



After connecting the GL100 to modules or sensors, please always check/set the time and date.



< Extension cable >

The module can be used approx. 1.5 m away from the GL100 by using an extension cable for GS (GS-EXC). However, you cannot connect and use multiple extension cables.

**Tip of the sensor mounting**

**1. Connect the AC Current Sensor (GS-AC\*\*A, sold separately) (1) Recording to the module.**

Connecting : Push the connector in until it locks in.

Disconnecting : Pull the connector out while pressing down on the lock on the bottom with your finger.

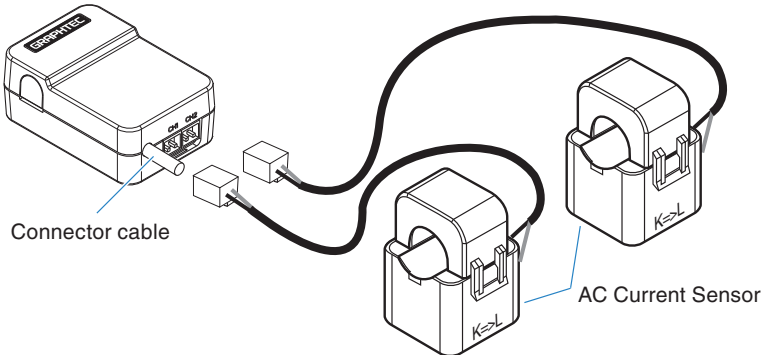

**WARNING** The connector is exclusively to be used to connect the AC Current Sensor. Do not connect it to voltages, other electrical currents, etc. It will damage the module.

**CAUTION** Pulling the AC Current Sensor's cable and holding the sensor by the cable will damage the cable's wires.

**2. How to measure with AC Current Sensor**

Remove the AC Current Sensor's lock, insert the measurement cable and push it in until it locks (putting the cable in the wrong way will cause the module to measure incorrectly).

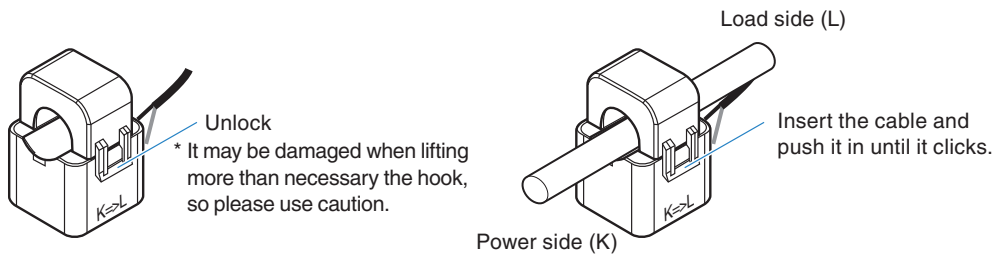

**CHECKPOINT**

Clamp ch1 or ch2 to L-phase when using single-phase 2-wire

Clamp ch1 and ch2 to R-phase and S-phase respectively when using single-phase 3-wire.

Clamp ch1 and ch2 to R-phase and T-phase respectively when using 3-phase 3-wire.

Example of wiring

< Single-phase 2-wire >

Load side (L)

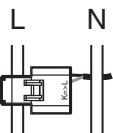

Power side (K)

< Single-phase 3-wire >

Load side (L)

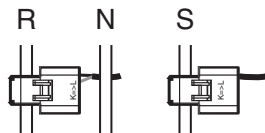

Power side (K)

< 3-phase 3-wire >

Load side (L)

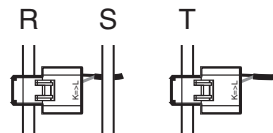

Power side (K)

**Tip of Settings**

**1. Various settings**

In AMP setting screen, select the measurement mode. Next select the sensor type to be used and then set the measurement voltage and power factor.

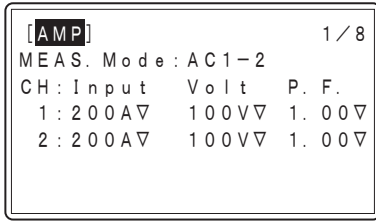

**MEAS. Mode**

AC1φ2W (2ch)	
Input	Off, 50, 100, 200A
DC-V	90 to 264V
Power factor	0.30 to 1.00
AC1φ3W, AC3φ3W	
Input	50, 100, 200A
DC-V	90 to 264V
Power factor	0.30 to 1.00

- Input: : Be sure to match to the AC current sensor type to be used.
- DC-V : Set the effective voltage to be measured. Since it is used to internally convert the current value, be sure to set to the correct value.
- Power factor : Specify the power factor to be measured.

The power factor is ratio of active power to (apparent) power, depends on the measuring object.

Since the power factor is used to internally convert the current value to the power value, it is required to adjust according to the measuring object.

**Formula used internally**

Actually the current value is measured. The power value is converted by multiplying the AMP setting voltage by the current value measured with the power factor (ratio of active power). (See the following formula.)

- AC1φ2W : Measurement setting when single-phase 2-wire is used  
2ch measurement is possible.  
\* Power = Measured current x Voltage x Power factor
- AC1φ3W : Measurement setting when single-phase 3-wire is used  
\* Power = (Measured current (ch1) + Measured current (ch2)) x Voltage x Power factor
- AC3φ3W : Measurement setting when three-phase 3-wire is used  
\* Power = ((Measured current (ch1) + Measured current (ch2)) ÷ 2) x Voltage x √3 x Power factor

**2. Example of measurement**

**(1) Measurement with single-phase 100V, 2 loads**

When the following connection is established, each current measurement for  $I$ ,  $I_a$ , and  $I_b$  is possible.

(The clamp in the following figure indicates the measurement point of AC current sensor.)

However, when measured by the GL100, it is not necessarily  $I = I_a + I_b$  (Since it is calculated in vector quantity.).

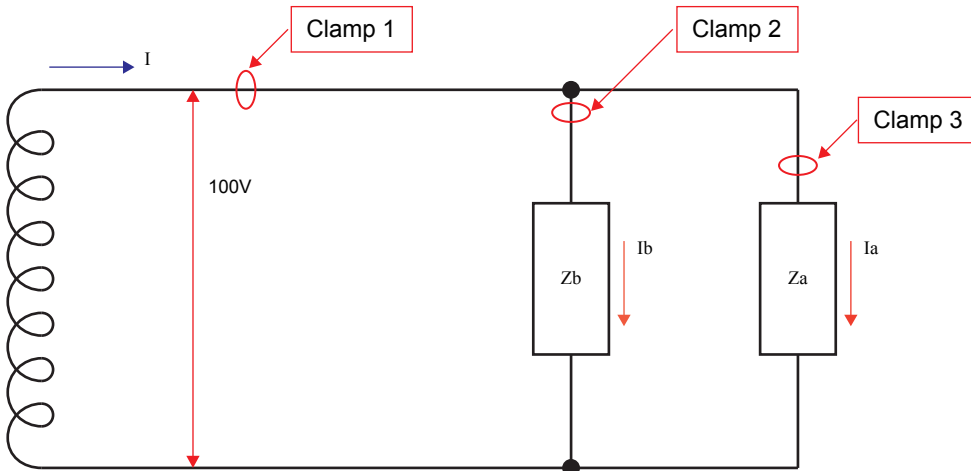

**(2) Single-phase 3-wire (100V and 200V)**

(The clamp in the following figure indicates the measurement point of AC current sensor.)

1) Single-phase 3-wire (AC1 $\phi$ 3W): Measured at the clamp 1 (CH1) and clamp 2 (CH2).

Current effective value of  $I_1 = I_a + I_b$  is measured at the clamp 1 (CH1).

Current effective value of  $I_3 = -I_a - I_c$  is measured at the clamp 2 (CH2).

**Note: Positive value is displayed regardless of the current direction because it is effective value.**

Total power is calculated in accordance with the set voltage 100V and power factor.

2) Single-phase 2-wire (AC1 $\phi$ 2W): Measured at the clamp 3, clamp 4 and clamp 5 in single-phase 2-wire mode.

Current effective value of  $I_b$  is measured at the clamp 3.

Current effective value of  $-I_c$  is measured at the clamp 4.

**Note: Positive value is displayed regardless of the current direction because it is effective value.**

Current effective value of  $I_a$  is measured at the clamp 5.

Each power is calculated in accordance with the set voltage 100V and power factor at the clamp 3 and clamp 4.

Power is calculated in accordance with the set voltage 200V and power factor at the clamp 5.

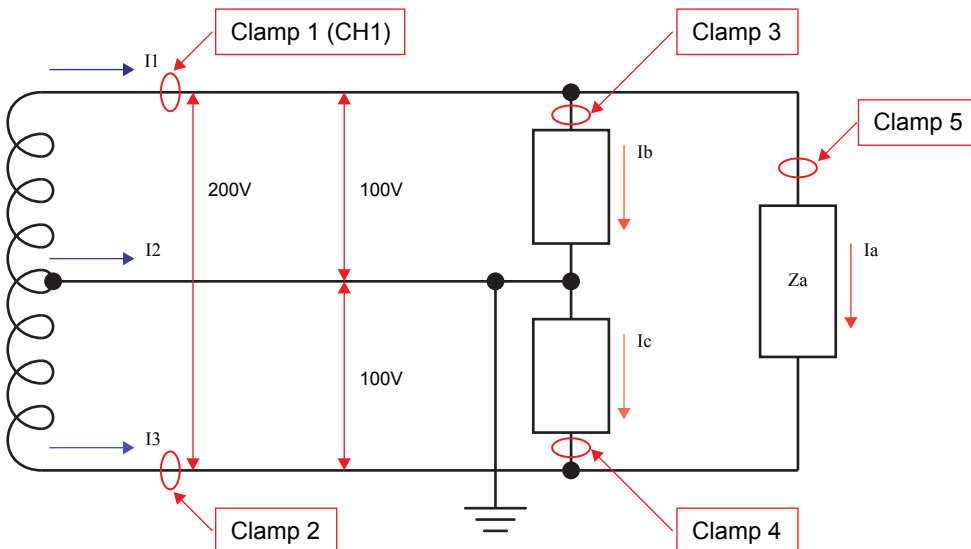

$$\begin{aligned}
 I_1 - I_2 - I_3 &= 0 \\
 I_1 &= I_a + I_b \\
 I_2 &= I_c - I_b \\
 I_3 &= I_a - I_c
 \end{aligned}$$

3) How to measure with three-phase 3-wire

(The clamp in the following figure indicates the measurement point of AC current sensor.)

Blondel's theorem: "When the number of electrical conductors is n, the multi-phase power can be measured by the watt-meter (n-1)". The Δ-connection and Y-connection are described below. The current effective value of R and T power line are measured at the clamp 1 and 2.

Using the Blondel's theorem, the GL100 calculates the power with the following formula.

$$\text{Power} = ((\text{Measured current (CH1)} + \text{Measured current (CH2)}) \div 2) \times \text{Set voltage} \times \sqrt{3} \times \text{Set power factor}$$

Measurement method: Measured at the clamp 1 (CH1) and clamp 2 (CH2) in three-phase 3-wire (AC3φ3W) mode.

The current effective value of R (U) phase is measured at the clamp 1 (CH1), and the current effective value of T (W) phase is measured at the clamp 2 (CH2).

The power is calculated in accordance with the set voltage and power factor.

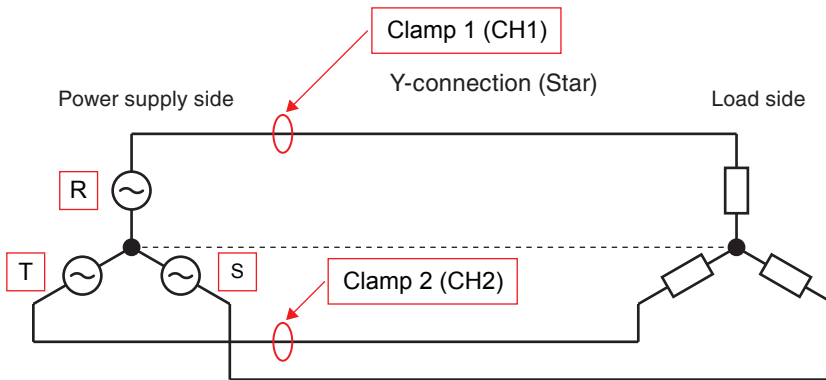
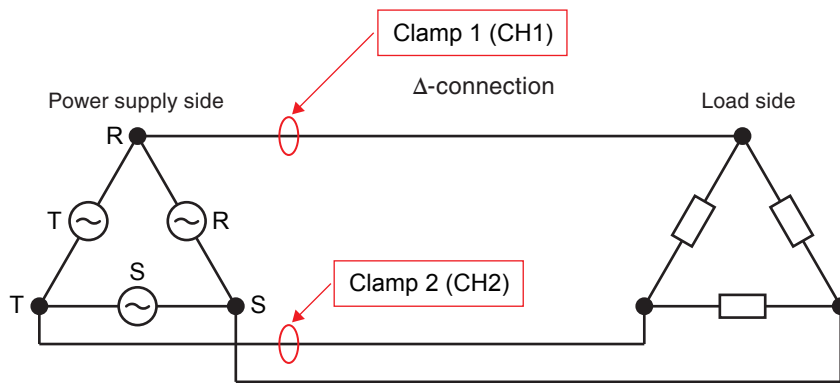

Note: If the current flows in the neutral conductor in the Y-connection, the measurement error occurs because the sum of the three phase currents is not zero.

**(3) Display screen**

In display screen

STOP	ALM.	1:28
1. AC (A) :	105.08 A	
PWR.	10.51 kW	
2. AC (A) :	105.08 A	
PWR.	10.51 kW	
BAT LAN SD	S: 1.0 s	

- The instantaneous power only is displayed during free-running.

**Accumulated Value**

During recording, you can switch to the accumulation screen by operating [◀] and [▶] keys.

REC.	ALM.	1:28
1. AC (A) :	105.08 A	
PWR.	10.51 kW	
2. AC (A) :	105.08 A	
PWR.	10.51 kW	
BAT LAN SD	S: 1.0 s	

Normal display



STOP	ALM.	1:28
1. AC (A) :	105.08 A	
PWR.	10.51 kWh	
2. AC (A) :	105.08 A	
PWR.	10.51 kWh	
BAT LAN SD	S: 1.0 s	

Accumulated value display

How to clear the accumulated value

To clear the accumulated value, follow the following procedure.

- When you start, the accumulated value is cleared and the accumulation operation is performed.  
The accumulation operation is performed even in trigger waiting state.

## Illumination / Ultraviolet Sensor (GS-LXUV): Optional

This section describes the name and function of each part.

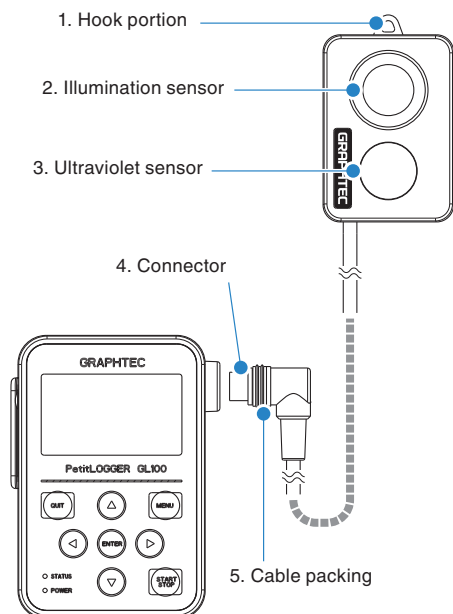

1. Hook portion ..... Used to mount to a wall.
2. Illumination sensor ..... Sensor unit that measures illumination rays.
3. Ultraviolet sensor ..... Sensor unit that measures ultraviolet rays.
4. Connector ..... Used to connect to the connector on the GL100 module.
5. Cable packing ..... This packing is used when connecting the connector.

- 
- CAUTION**
- When measuring ultraviolet rays that have an effect on the eyes or the skin, wear protective glasses, apply light shielding, etc.
  - If the sensor unit becomes dirty, this may affect measurements. Wipe it down with a soft cloth.
  - Make sure to handle the sensor unit in a way that it will not crack. If the sensor unit is cracked it may affect measurements. Replace the sensor if cracked.
- 

---

**CHECKPOINT** After connecting the GL100 to modules or sensors, please always check/set the time and date.

---



---

**CHECKPOINT** < Extension cable >  
The module can be used approx. 1.5 m away from the GL100 by using an extension cable for GS (GS-EXC). However, you cannot connect and use multiple extension cables.

---



### Tip of measurement

The illumination wavelength is 560 nm and the peak of spectral sensitivity is UV wavelength 370 nm.

<Spectral Sensitivity Characteristic>

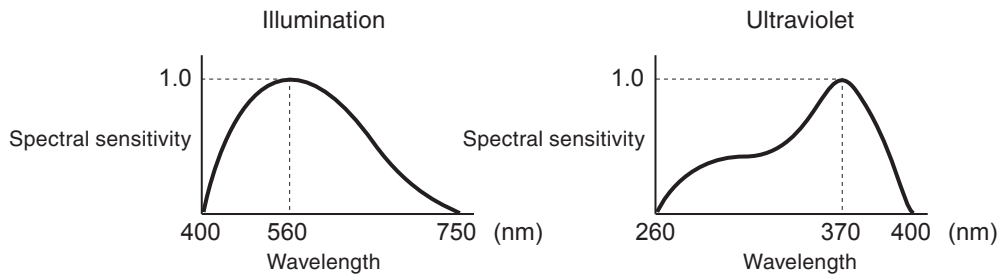

### Accumulated Value

During recording, you can switch to the accumulation screen by operating [◀] and [▶] keys.

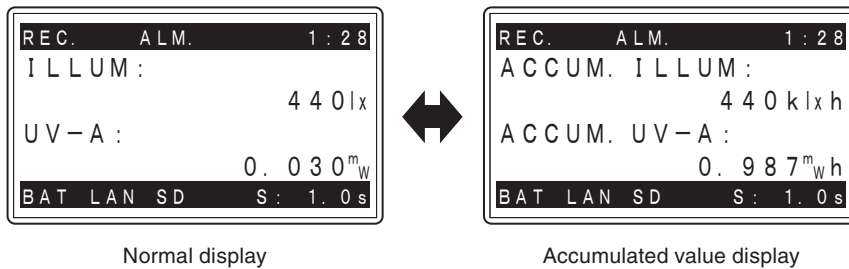

### How to clear the accumulated value

To clear the accumulated value, follow the following procedure.

- When you start, the accumulated value is cleared and the accumulation operation is performed. The accumulation operation is performed even in trigger waiting state.

## CO<sub>2</sub> Sensor (GS-CO2): Optional

This section describes the name and function of each part.

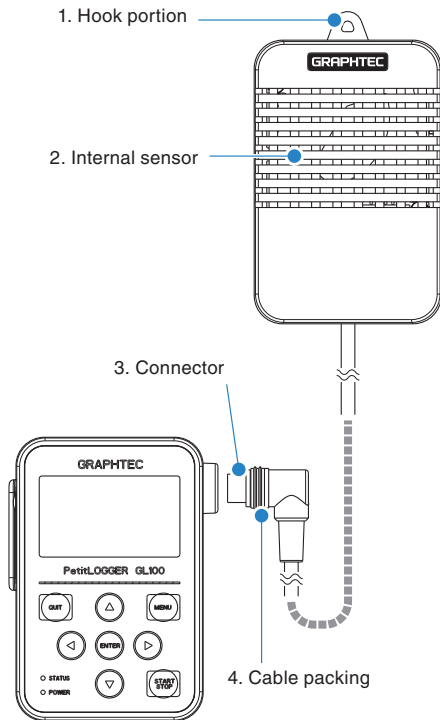

1. Hook portion ..... Used to mount to a wall.
2. Internal sensor ..... There is an internal sensor that detects the CO<sub>2</sub>.  
The lamp for detecting flashes every two seconds.
3. Connector ..... Used to connect to the connector on the GL100 module.
4. Cable packing ..... This packing is used when connecting the connector.

- 
- CAUTION**
- The battery is not available for power supply. Use the USB cable to supply the power.
  - Do not use the module close to your face.  
Your breath may affect measurements.
  - Blocking the module's aperture may cause the airflow to affect measurements.
- 

---

**CHECKPOINT** After connecting the GL100 to modules or sensors, please always check/set the time and date.

---



---

**CHECKPOINT** < Extension cable >  
The module can be used approx. 1.5 m away from the GL100 by using an extension cable for GS (GS-EXC). However, you cannot connect and use multiple extension cables.

---

## Temperature / Humidity Sensor (GS-TH): Optional

This section describes the name and function of each part.

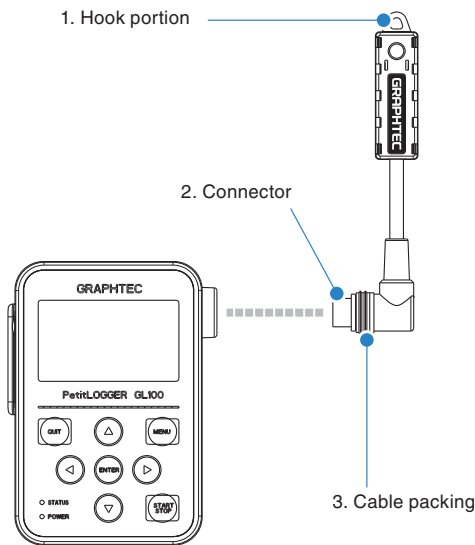

1. Hook portion ..... Used to mount to a wall.
2. Connector ..... Used to connect to the connector on the GL100 module.
3. Cable packing ..... This packing is used when connecting the connector.

---

**CAUTION** Attaching just this module to the wall, etc. will damage the connector cable. Always connect to the GL100.

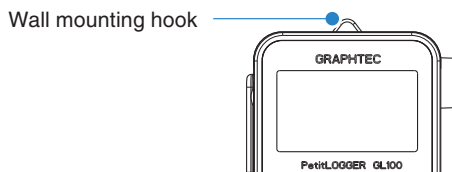

---

**CAUTION** The temperature sensor measures the change in capacitance of the conductivity caused by moisture absorption. Therefore, dust, fumes and other organic compound may affect measurements. Usage in an environment with a large quantity of these substances floating about will cause large measurement deviations.

---

**CHECKPOINT** After connecting the GL100 to modules or sensors, please always check/set the time and date.

---

**CHECKPOINT** < Extension cable >  
The module can be used approx. 1.5 m away from the GL100 by using an extension cable for GS (GS-EXC). However, you cannot connect and use multiple extension cables.

---

## Accumulated Value

During recording, you can switch to the accumulation screen by operating [◀] and [▶] keys.

REC.	ALM.	1:28
TEMP :	+34.1	°C
HUM. :	+59.8	°C
DEWP :	+12.18	°C
BAT LAN SD	S: 1.0	s

Normal display



REC.	ALM.	1:28
ACCUM. TEMP :	+65535	°C h
BAT LAN SD	S: 1.0	s

Accumulated value display

### How to clear the accumulated value

To clear the accumulated value, follow the following procedure.

- When you start, the accumulated value is cleared and the accumulation operation is performed.  
The accumulation operation is performed even in trigger waiting state.

## Adapter for Branch Adapter (GS-DPA): Optional

This section describes the name and function of each part.

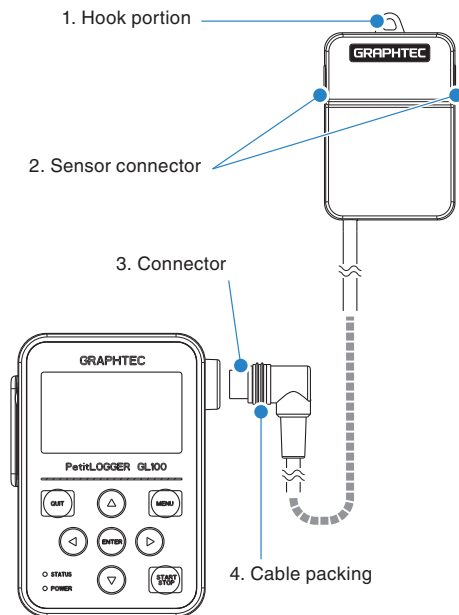

1. Hook portion ..... Used to mount to a wall.
2. Sensor connector ..... The sensor connectors are on the left and right.
3. Connector ..... Used to connect to the connector on the GL100 module.
4. Cable packing ..... This packing is used when connecting the connector.



- CAUTION**
- The GL100 has basic water protection but this module has no water protection. Be careful when installing and handling.
  - Before connecting to the GL100, always connect all of the sensors to the branch adapter and then connect.
  - When using the CO<sub>2</sub> sensor in combination with other sensors, always use a USB cable connection as the power source.
  - The sensor connector is used for GS-LXUV, GS-CO<sub>2</sub> or GS-TH only. Please do not connect the device other than them. The GL100-N/GL100-WL may be damaged.



< Extension cable >

The module can be used approx. 1.5 m away from the GL100 by using an extension cable for GS (GS-EXC). However, you cannot connect and use multiple extension cables.

**Tip of the sensor combination.**

**CAUTION** It is not possible to be used by connecting two same sensors.

**CHECKPOINT** < Extension cable >  
The module can be used approx. 1.5 m away from the GL100 by using an extension cable for GS (GS-EXC). However, you cannot connect and use multiple extension cables.

There are the following three sensor combinations.

**1. Combined illumination / ultraviolet sensor and temperature and humidity sensor measurement**

Composite measurement can be done by using the illumination / ultraviolet sensor (GS-LXUV) and the temperature and humidity sensor (GS-TH) (each sold separately).

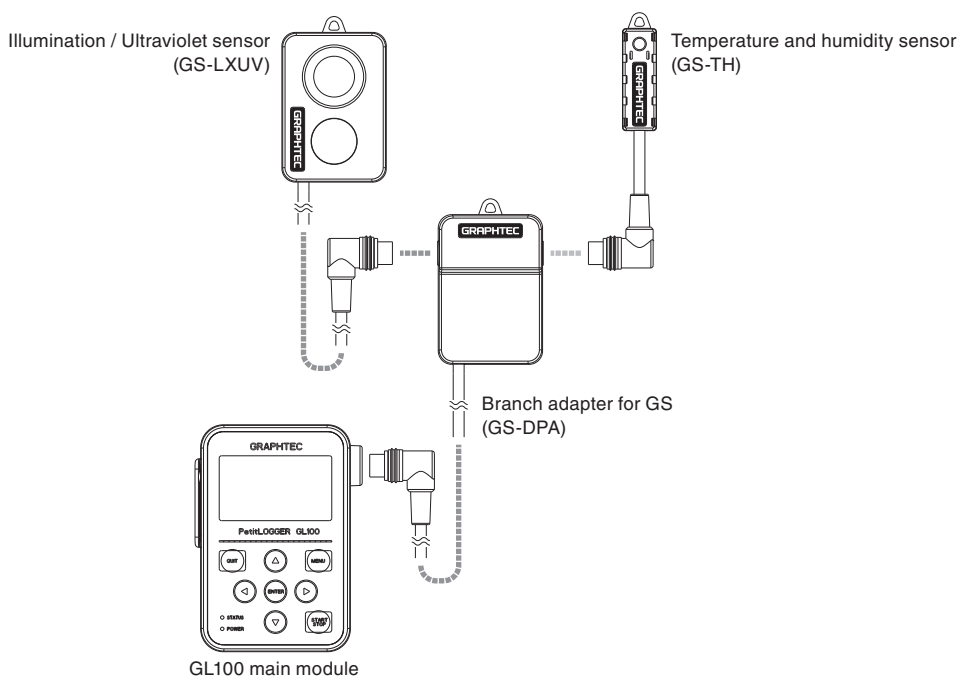

2. Combined CO<sub>2</sub> sensor and temperature and humidity sensor measurement

Composite measurement can be done by using the CO<sub>2</sub> sensor (GS-CO2) and the temperature and humidity sensor (GS-TH) (each sold separately).

**WARNING** If the CO<sub>2</sub> sensor (GS-CO2) is included in the assembly, it cannot be powered with batteries.

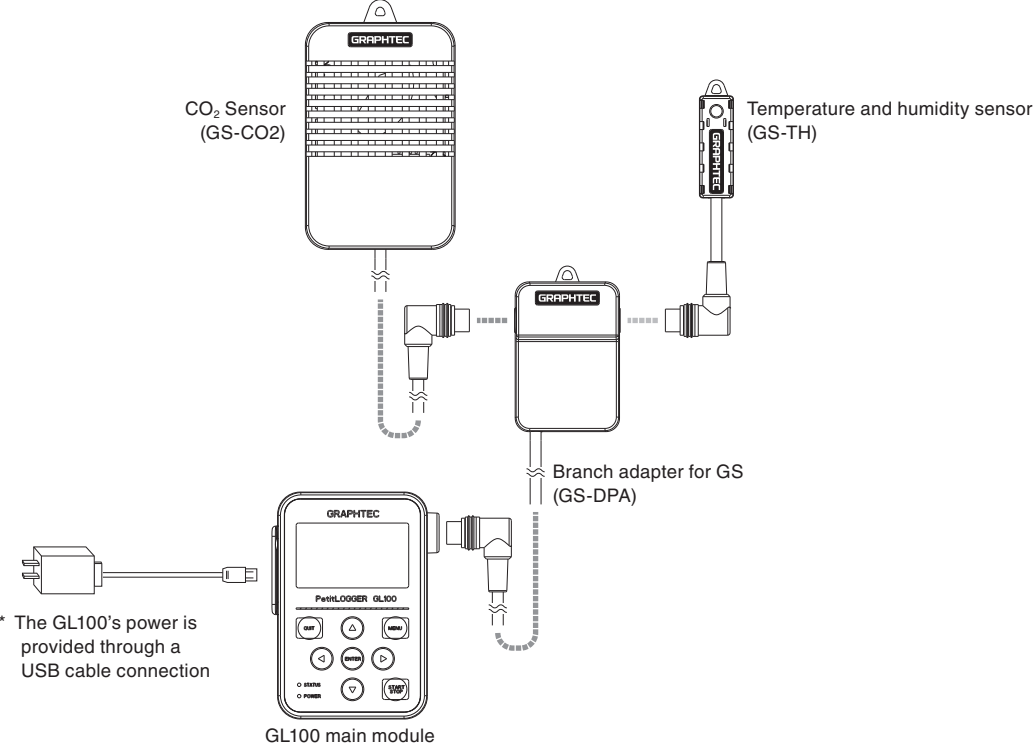

### 3. Combined CO<sub>2</sub> sensor and illumination / ultraviolet sensor

Composite measurement can be done by using the CO<sub>2</sub> sensor (GS-CO2) and the illumination / ultraviolet sensor (GS-LXUV) (each sold separately).

---

**WARNING** If the CO<sub>2</sub> sensor (GS-CO2) is included in the assembly, it cannot be powered with batteries.

---

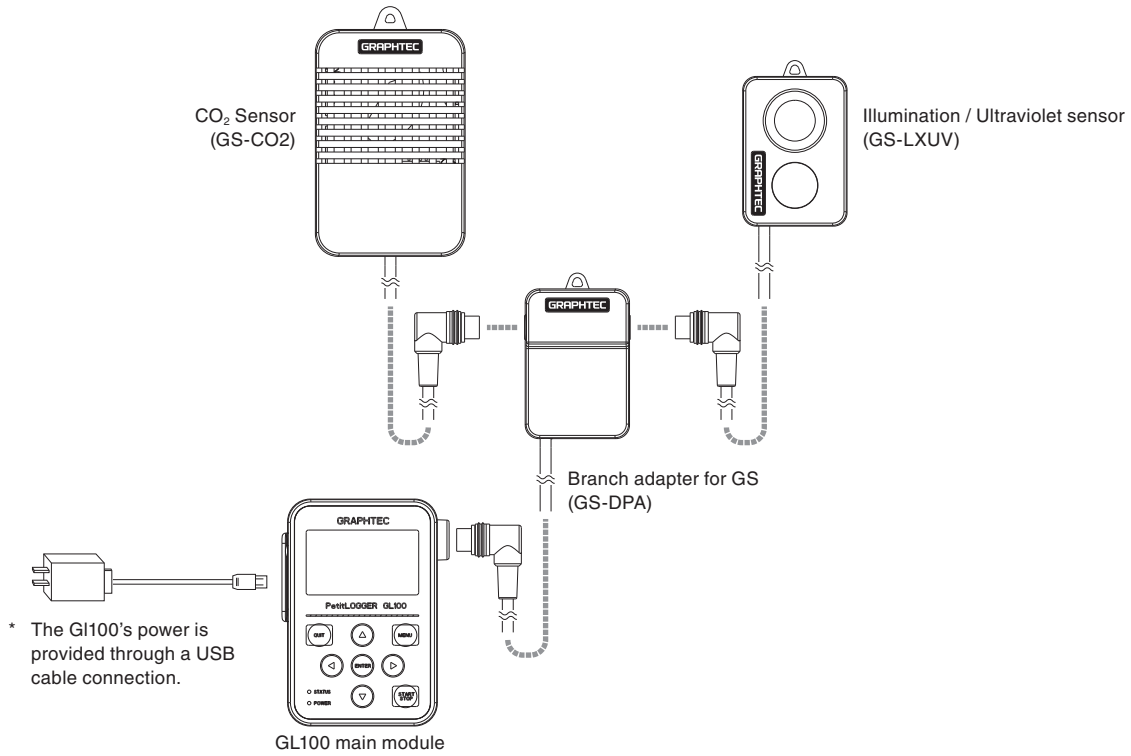



## Accumulated Value

By switching the displayed data, the recorded data can be displayed in detail during data recording.

### 1. Combined measurement of the illumination / ultraviolet sensor and temperature and humidity sensor

In display screen, two measurements of illumination / ultraviolet sensor and temperature and humidity sensor are displayed.

During recording, you can switch to the accumulation screen by operating [ $\leftarrow$ ] and [ $\rightarrow$ ] keys.

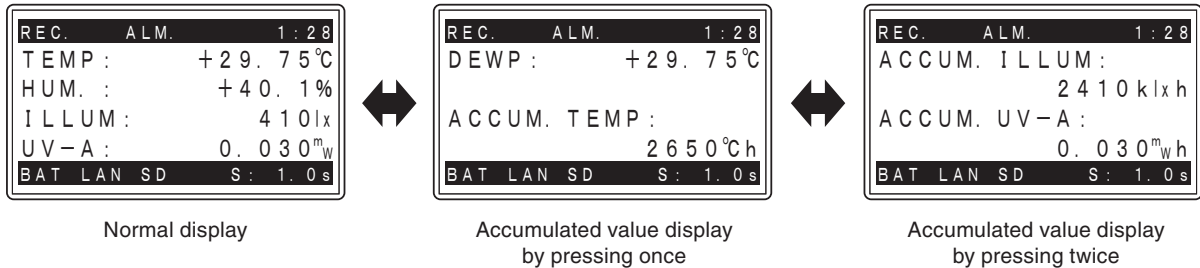

### 2. Combined measurement of the CO<sub>2</sub> sensor and temperature and humidity sensor

In display screen, two measurements of CO<sub>2</sub> sensor and temperature and humidity sensor are displayed.

During recording, you can switch to the accumulation screen by operating [ $\leftarrow$ ] and [ $\rightarrow$ ] keys.

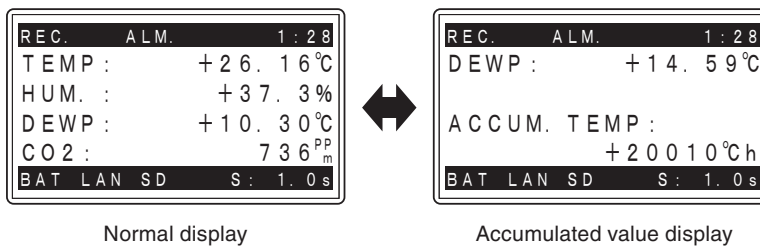

### 3. Combined measurement of the CO<sub>2</sub> sensor and illumination / ultraviolet sensor

In display screen, two measurements of CO<sub>2</sub> sensor and illumination / ultraviolet sensor are displayed.

During recording, you can switch to the accumulation screen by operating [ $\leftarrow$ ] and [ $\rightarrow$ ] keys.

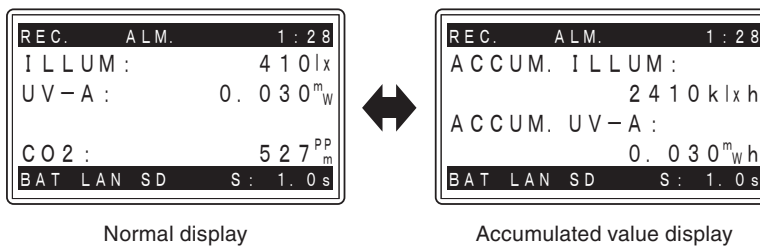

#### How to clear the accumulated value

To clear the accumulated value, follow the following procedure.

- When you start, the accumulated value is cleared and the accumulation operation is performed.

The accumulation operation is performed even in trigger waiting state.



# CHAPTER 3 Measure and Set

---

This chapter explains how to check the main module's external casing and accessories, and how to prepare the main module for operation.

## **Product Summary**

- 3.1 Before Setting Up**
- 3.2 Power-on**
- 3.3 Date/Time Adjustment**
- 3.4 Measurement Procedure**

## 3.1 Before Setting Up

When you connect the module and power supply to the GL100, various screen display and operation are possible.

First, set the date/time and language (English/Japanese) and then set up various settings.

- 1) Power-on : Refer to “3.2 Power-on”.
- 2) Setting date : When the power is consumed, the set values returns to the default values. Be sure to set them in accordance with “3.3 Date/Time Adjustment”.
- 3) Setting languag : The default display language is English. To switch the display language to Japanese, refer to ” Setting Language” in “3.4 Measurement Procedure”.

## 3.2 Power-on

This GL100 can be powered by alkaline batteries, an AC adaptor (USB cable connection) or a PC (USB cable connection).

Refer to the following description.

**⚠ CAUTION** Wait about 20 seconds until the power is turned on again after power off.  
If the sensors and modules are not recognized, check the connections and restart the GI100. Turn on after waiting about 20 seconds.  
When the power is supplied, it is ready for operation by holding down the [MENU] key.

### How to Switch On the Power

When the screen is not displayed after power-on, the GL100 is ready for operation by holding down [MENU] key.

When the module is not connected, the “SENSOR ERROR!!” is displayed. When the module is connected properly, the “Sleeping!!” is displayed.

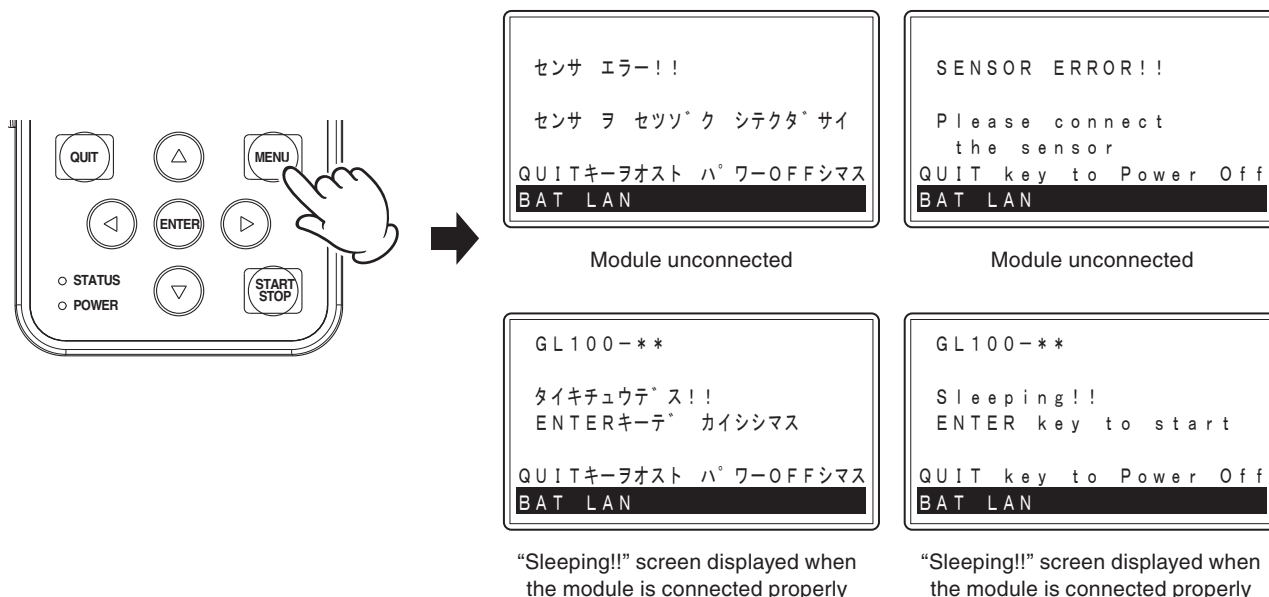

#### **TIP** <When using GL100-WL>

- When the wireless LAN mode in the I/F setting is other than OFF, the wireless LAN is enabled in Standby state.
- When the wireless LAN is not used, set the wireless LAN mode in the I/F setting to OFF. In the case of battery use, the alkaline battery life is extended.

## How to Switch to Power OFF Mode

To switch to this mode while the “Sleeping!!” screen is displayed, press [QUIT] key.  
(This screen is displayed when the power is supplied and the module is connected.)

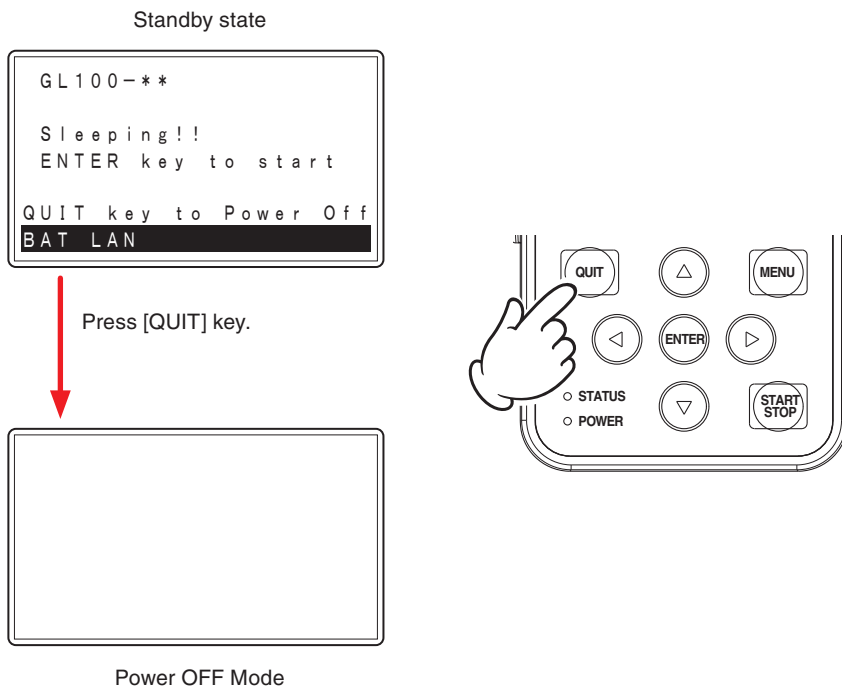

In this case, there is nothing displayed in this screen.

The GL100 is ready for operation and the “Sleeping!!” screen above is displayed by holding down [MENU] key.

- When BAT (Low Battery Status) is displayed in the bottom left corner of the LCD screen, it is not possible to proceed to the next screen for the battery shortage.  
Press [QUIT] key to switch to Power OFF Mode and replace the battery.
- When BAT (Low Battery Status) and LAN connecting state is displayed in the bottom left corner of the LCD screen, it is not possible to proceed to the next screen for the battery shortage.  
Press [QUIT] key to switch to Power OFF Mode and replace the battery. In this case, since the LAN connection is disabled, re-connect to the LAN after replacing the battery.

---

**CAUTION** There is no screen display while the screen saver is running, but the Power lamp (green) flashes. In such cases, the screen is displayed by pressing any key.  
When the Power lamp (green) does not flash, the GL100 is in Power OFF state. In such cases, hold down [MENU] key.

---



---

**TIP** <Power OFF Mode>  
By switching to the Power OFF Mode, the battery life is extended when not in use.  
New alkaline battery life is about 5 months. (at 25°C).

---

### 1. How to install the batteries

- (1) Loosen the screws on the back cover.

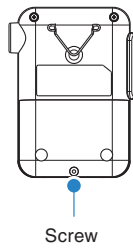

- (2) Remove the back cover.

- (3) Insert two AA alkaline batteries.

\* Make sure to insert the batteries the right way.

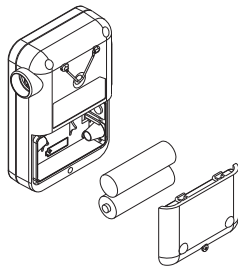

- (4) Attach the back cover and tighten the screws.

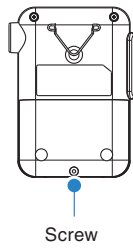

---

**CAUTION** Make sure to use two size AA alkaline batteries.  
Do not use zinc-carbon batteries or nickel hydride (rechargeable) batteries.

---

## 2. How to connect AC adapter (USB cable connection)

### (1) Connecting AC adapter

Connect this module to a commercial AC adaptor using a USB cable.

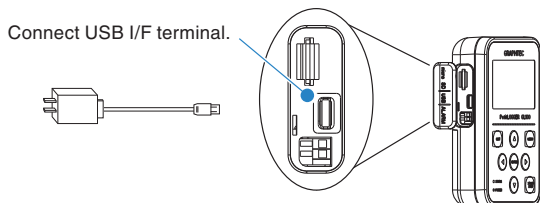

- 
- ⚠ CAUTION**
- Make sure to use an AC adaptor rated 5V (at least 1A).
  - Smartphone chargers cannot be used, because they usually have overcharge protection lines that may identify this module as being fully charged and stop output.
- 

### (2) How to connect to PC

Please use the included USB cable and connect the USB I/F terminal to a PC.

\* IEC60950-1-certified product with a USB output compatible with the Limited Power Source.

- 
- ⚠ CAUTION**
- Make sure to use a USB cable connection rated 5V (at least 200mA).
  - Do not connect via a USB hub.
- 

- The recommended power sources for each combination of modules are listed below.

Setting items	Sensor module connected	Built-in alkaline battery	USB cable connection
Temperature and humidity measurement	GS-TH	B	A
3-axis acceleration / Temperature Measurement	GS-3AT	B	A
4ch voltage / temperature measurement	GS-4VT	C	A
4ch thermistor temperature measurement	GS-4TSR	B	A
Illuminance / Ultraviolet measurement	GS-LXUV	B	A
CO2 measurement	GS-CO2	D	A
AC current / power measurement	GS-DPA-AC	B	A
Temperature and humidity + CO2 measurement	GS-DPA+GS-TH+GS-CO2	D	A
Temperature and humidity + illumination /UV measurement	GS-DPA+GS-TH+GS-LXUV	B	A
CO2 + illumination / UV measurement	GS-DPA+GS-CO2+GS-LXUV	D	A

\*: The GS-DPA listed is a measurement that uses the branch adapter for GS.

A: Full operation

B: This works on alkaline batteries.

C: This works on alkaline batteries, but power consumption is relatively high, the operating time will be shorter.

D: Cannot be used as a power source



- **DC current consumption is as follows.**

When driving in the batteries, use as a reference of battery consumption.

Model	Power Supply	Wireless LAN	LCD Backlight	Screen-saver	SD Card	Consumption current (mA)						
						TH	3AT	4VT	4TSR	AC	LXUV	CO2
GL100-WL	Battery (3V)	OFF	MAX	OFF	No	15	17	120	24	29	24	-
			OFF	OFF	No	6	8	110	15	20	15	-
			-	ON	No	5	7	109	14	19	14	-
			-	ON	Yes	6	8	110	15	20	15	-
	USB (5V)	ON	MAX	OFF	No	108	108	168	112	120	115	135
			OFF	OFF	No	102	102	162	108	116	110	130
			-	ON	No	100	100	160	107	114	109	128
			-	ON	Yes	102	102	162	109	116	111	130
GL100-N	Battery (3V)	OFF	MAX	OFF	No	14	16	118	22	28	22	-
			OFF	OFF	No	5	7	108	14	19	14	-
			-	ON	No	4	6	107	13	18	13	-
			-	ON	Yes	5	7	108	14	19	14	-
	USB (5V)	OFF	MAX	OFF	No	18	21	79	25	31	25	46
			OFF	OFF	No	13	16	74	20	26	20	41
			-	ON	No	12	15	73	19	25	19	40
			-	ON	Yes	13	16	74	20	26	20	41

\* The above value is the average value of the body + sensor.

\* There is no change in consumption current by the sampling rate.

\* The consumption current increases up to about 20 mA while accessing the SD card.

\* When the CO<sub>2</sub> sensor is used, the consumption current increases periodically (about two-second intervals) about 500 mA.

### 3.3 Date/Time Adjustment

After connecting the module and power source to the GL100, set the date and time in accordance with the following procedure.

**CAUTION** Life of the internal clock back-up battery is about 10 hours.  
When the power has been not supplied for a long time, the set date and time are reset. Always check the date and time after connecting the module. If this date and time is wrong, the data name when recorded is different from the real time.

**CHECKPOINT**

- Hold down the [QUIT] key (approx. 3 seconds) to put the module into standby state.
- In the case of battery-powered, put the module into standby state automatically if you do not operate for 3 minutes.
- Press [ENTER] key in Standby state to return to the free-running screen.

1. Set up the power source
2. Prepare the GL100-N/GL100-WL and modules.  
If not connecting the module, it is not possible to set.
3. Perform the following procedure (GL-TH is used in this procedure).
  - 1) Before connecting the module, the following screen is displayed.

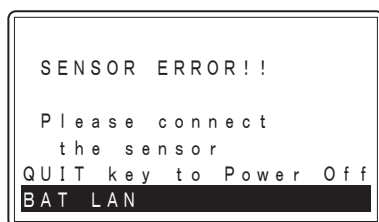

Module unconnected state

- 2) Connect the (GL-TH) module to the GL100-N/GL100-WL.

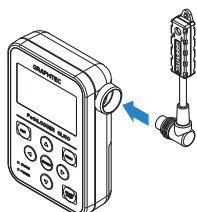

The following screen is displayed after connecting it.



Recognition of module types

The GL100-N/GL100-WL is in standby state after recognizing the module type.



Standby state

3) Press [ENTER] key to display the free-running screen.

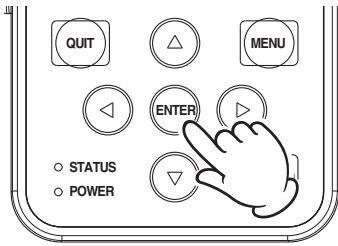

The free-running screen is displayed after confirming the module conditions.

Free-running screen

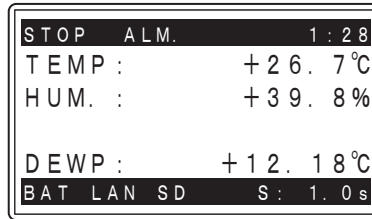
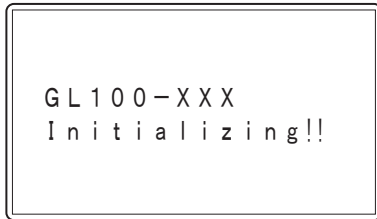

4) Press [MENU] key to display the setting screen.

First page of the setting screen is displayed..

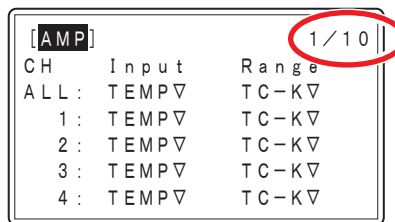
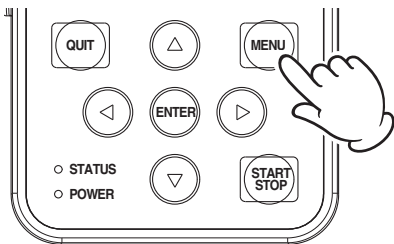

5) Display the date and time adjustment page (8/10).

Press [▽] key or [MENU] key until the page is switched to the "OTHER-1" page.

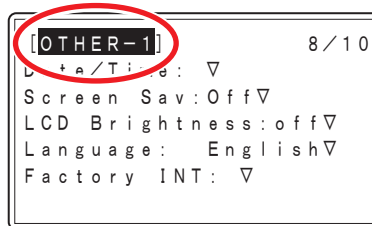
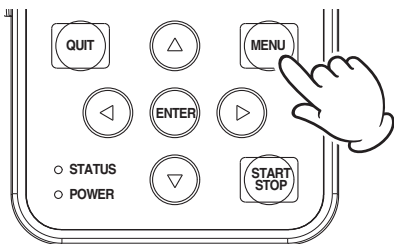

Or

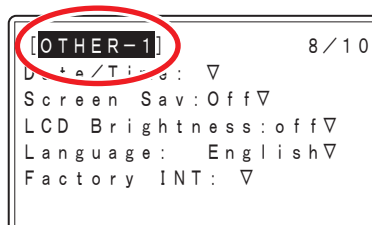
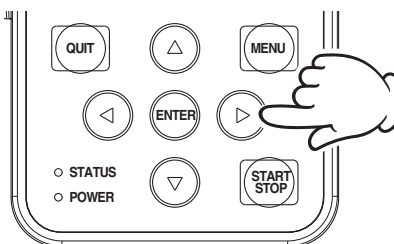

6) Select the display mode (Mode).

Press [▽] key until the “Data/Time” is highlighted.

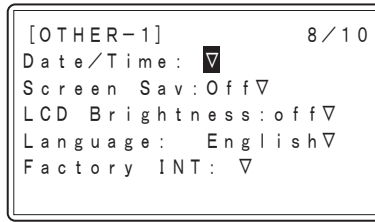
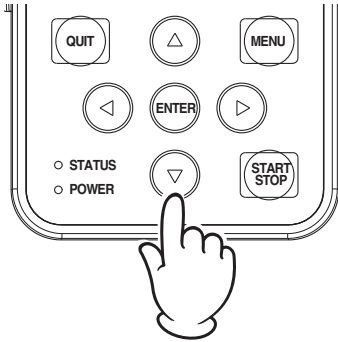

Press [ENTER] key to display the “Mode” setting screen.

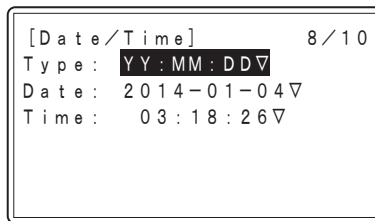
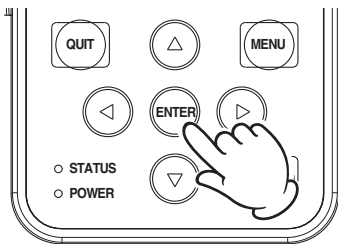

Again press [ENTER] key to select the Display mode using [△] or [▽] key. Press [ENTER] key to confirm it.

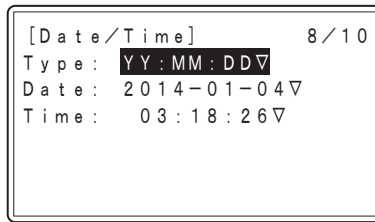
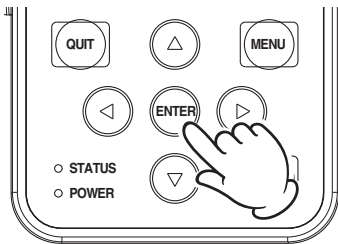

7) Set the date.

Press [▽] key to highlight the Date.

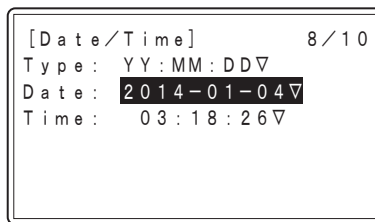
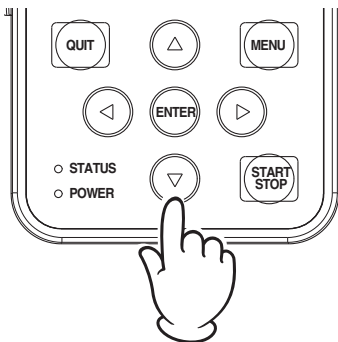

Again press [ENTER] key to display the screen to change the value.

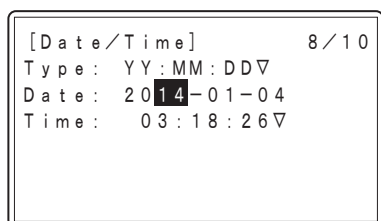

Press [△] or [▽] key to increase or decrease the value.

To adjust the value of MM:DD, highlight the value to be modified by operating [◀] or [▶] key and then adjust it by operating [△] or [▽] key. Press [ENTER] key to confirm it after completion.

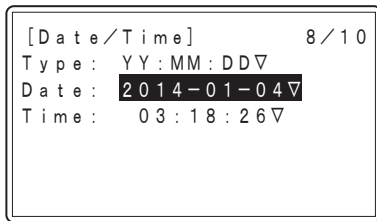

### 8) Set the time.

Press [▽] key to highlight the "Time".

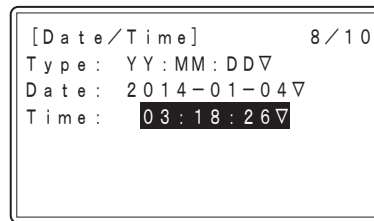
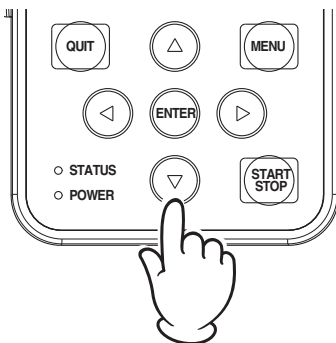

Press [ENTER] key to display the screen to change the value.

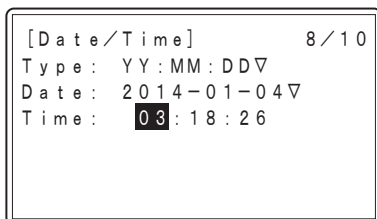

Press [△] or [▽] key to increase or decrease the value.

Highlight the value to be modified by operating [◀] or [▶] key and then adjust it by operating [△] or [▽] key.

Press [ENTER] key to confirm it after completion.

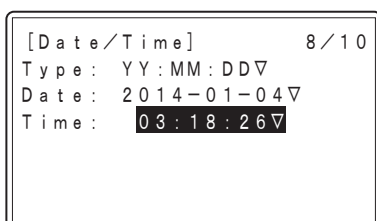

### 9) Complete the Data/Time adjustment

When completing the settings, press [QUIT] key to return to the free-running screen.

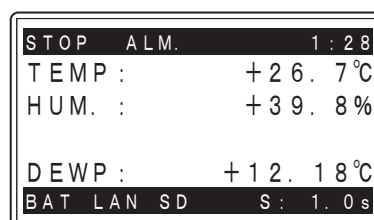
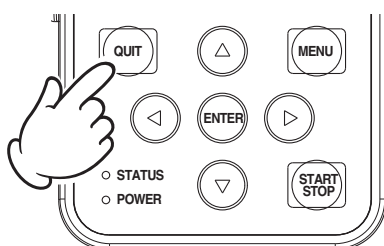

## 3.4 Measurement Procedure

The measurement procedure is described in the following order.

1. Supply the power
2. Connect the modules
3. Set the common items (OTHER-1)
4. Set the measurement conditions
5. Start or stop the measurement
6. How to confirm the recorded data

### 1. Supply the power

Supply the power to the GL100-N/GL100-WL (Refer to “3.2 Power-on”).

### 2. Connect the modules

Connect the module to display the free-running screen. (Refer to Step 3 in “3.3 Date/Time Adjustment”).

### 3. Set the common items (OTHER-1)

In setting screen, set the common items (Refer to Step 4 in “3.3 Date/Time Adjustment”).

Common settings (OTHER-1)

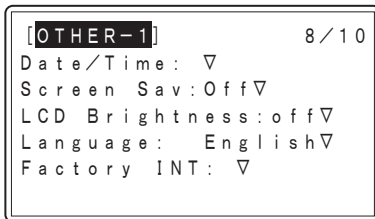

- Date/Time ..... Be sure to check the date and time after power-on.

Mode	YY:MM:DD, DD:MM:YY
Date	2014-07-01, 07-01-2014
Time	10:10:00 (Hour:Minute:Second)

- Screen Sav ..... Set the time to turn off the screen when the GL100 is not in operation.

Screen-saver	Off, 1, 2, 5, 10, 20, 30, 60 min.
--------------	-----------------------------------

**⚠ CAUTION** There is no screen display while the screen saver is running, but the Power lamp (green) flashes. In such cases, the screen is displayed by pressing any key.  
 When the Power lamp (green) does not flash, the GL100 is in Power OFF state. In such cases, hold down [MENU] key.

- LCD Brightness ..... Adjust the brightness of LCD backlight.

LCD brightness	Off, Dark, Middle, Bright
----------------	---------------------------

- Language ..... The display language can be switched to English or Japanese. (The default display language is English.)

Language	English, Japanese
----------	-------------------

- Factory INT .....Return to the factory settings.

All settings will be reset, so please use caution.

Yes: (ENTER)	When [ENTER] key is pressed, the settings are initialized.
No: (QUIT)	To quit this screen without changing, press [QUIT] key.

<Display language of GL100-N/GL100-WL>

Initial menu is displayed in English.

When you want to display in English, switch to English in accordance with the following procedure.

- 1) Supply the power to the GL100-N/GL100-WL.
- 2) Next, connect the module to the GL100-N/GL100-WL (Example of GS-TH connection).

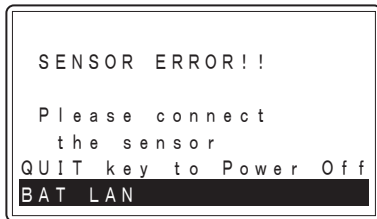

Module unconnected state



Recognition of module types



Standby state

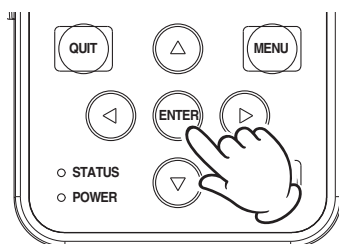

Free-running screen

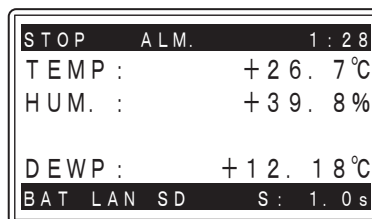

- 3) Press [MENU] key to display the setting screen.

First page of the setting screen is displayed.

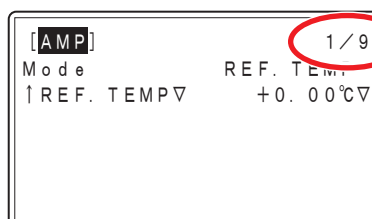
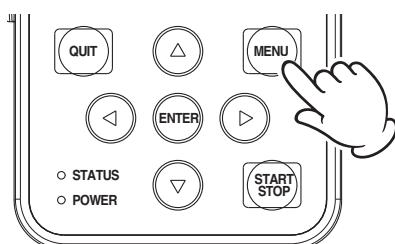

4) Display the language display item.

Press [MENU] key until the "OTHER-1" is displayed.

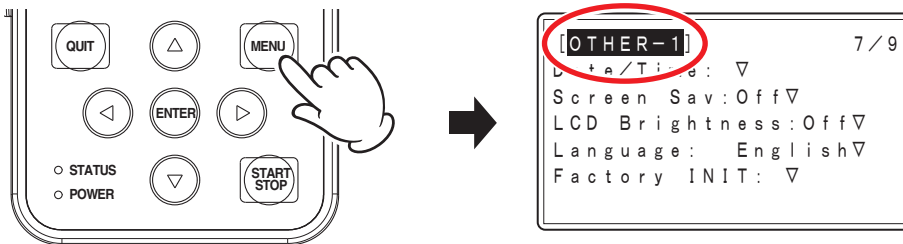

5) Select the language display.

Using [▽] key, highlight the "Language" (English).

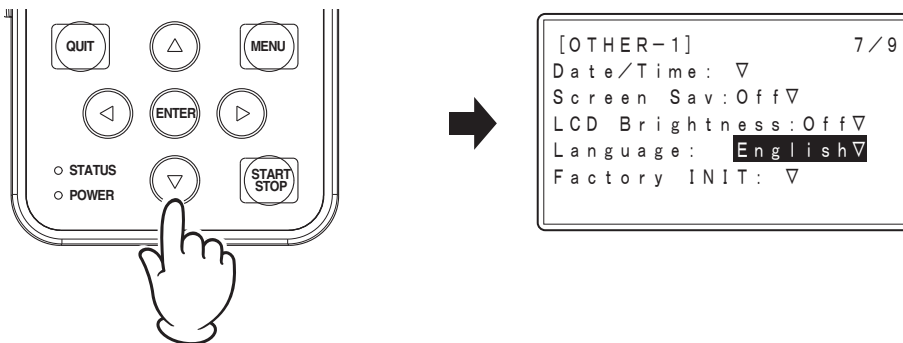

Press [ENTER] key to display the "Language" setting screen.

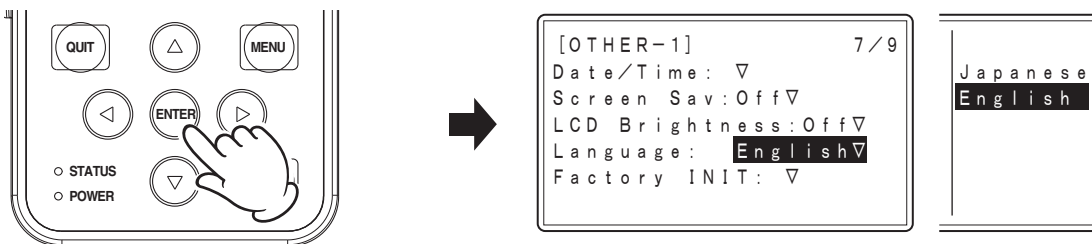

Using [△] and [▽] keys, select the "English".

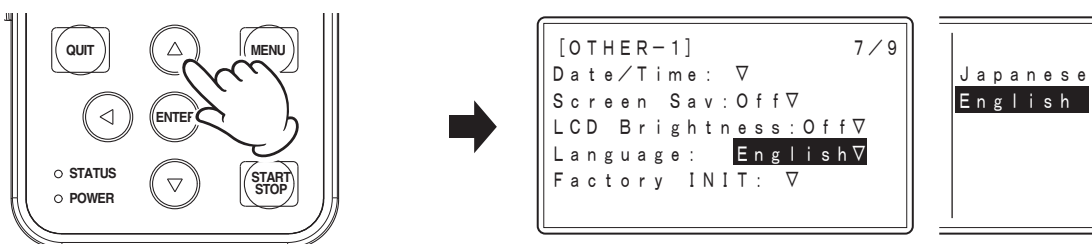

Press the [ENTER] key to confirm it.

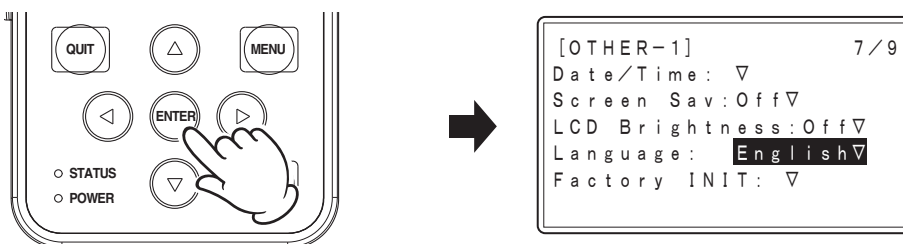

The English display procedure is complete.



### 4. Set the measurement conditions

In Setting screen, set the measurement conditions.

The measurement conditions varies depending on the module. Refer to the USER'S MANUAL for each module.

The following shows an example. (Example of GS-4VT connection)

#### AMP

Set the conditions of input signal to be measured.

(The displayed information varies depending on the module.)

<b>[AMP]</b>		1 / 10
CH	Input	Range
ALL :	TEMP ▾	TC-K ▾
1 :	TEMP ▾	TC-K ▾
2 :	TEMP ▾	TC-K ▾
3 :	TEMP ▾	TC-K ▾
4 :	TEMP ▾	TC-K ▾

ALL	The settings of 1 to 4 channels can be set at a time.
1 to 4 Input	Set Off, Voltage, Temperature.
Range	Voltage: 20, 50, 100, 200, or 500 mV, 1, 2, 5, 10, 20, 50V; 1-5V Temperature: TC-K (K-type thermocouple), TC-T (T-type thermocouple)

#### LOGIC

Set the conditions (input or slop) of Logic/Pulse input signal.

(The displayed information varies depending on the module.)

<b>[LOGIC]</b>		2 / 10
Input Mode: Logic ▾		
CH:	Input	Slope
1 :	Off ▾	
2 :	Off ▾	
3 :	Off ▾	
4 :	Off ▾	

Input Mode	Logic/Pulse
Logic	Set Off, Voltage, Temperature
Range	Voltage: 20, 50, 100, 200, 500mV 1, 2, 5, 10, 20, 50V; 1-5V Temperature: TC-K (K-type thermocouple), TC-T (T-type thermocouple)

**DATA**

Set the data recording conditions.

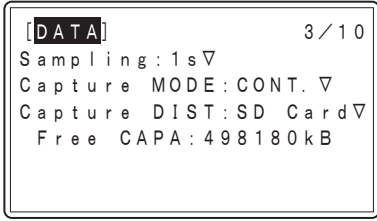

- Sampling ..... Sets the timing of data capture.

Sampling	0.5, 1, 2, 5, 10, 20, 30 sec. 1, 2, 5, 10, 20, 30, 60 min.
----------	---

- Capture MODE ..... Sets the interval of data file.

Capture MODE	Continuous	The data from the start to the stop is recorded in a file. However, the file size is approx. 1.9GB per one file.
	1Hour	Data file is generated every hour after starting.
	24Hour	Data file is generated every 24 hours after starting.

**TIP**

- When ‘ Continuous’ is selected, the data file is not generated when the power is consumed. It is recommended that you set the ‘ 24Hour’ or ‘ 1Hour’ periodically generated data file.
- When the ‘ Capture Mode’ is set to 1Hour or 24Hour, a few points of data points may be moved depending on the sampling rate. Duplication and omission of the data does not occur.

- Capture DIST ..... Select the internal memory (4.9M bytes) or micro SD card.  
However, you cannot select the micro SD card when it has not been inserted.

Capture DIST	Memory, SD card
--------------	-----------------

Recommended SD card: TS4GUSDHC4 (Transcend)

**TIP**

1) When selecting the SD card

When the ‘ Capture DEST’ is switched from Memory to SD card, the following screen is displayed.

Press [ENTER] key to copy the contents in the Memory to the SD card.

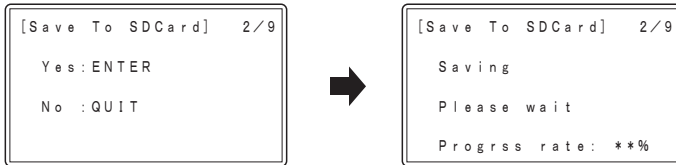

When the copy is complete, the free space is checked and then the space is displayed. When pressing [QUIT] key, the free space is checked and then the space is displayed without copying it.

2) When selecting the Memory

When switching from SD card to Memory, the following screen is displayed.

When [ENTER] key is pressed, the memory is erased. (It takes about 3 minutes.)

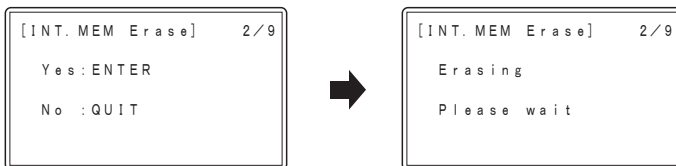

When pressing [QUIT] key, the Memory is set.

**Tip of memory recording time**

The memory recording time varies depending on the memory capacity.  
For the recording time, refer to the recording time in the following table.

Recording conditions

- Recording destination: Internal memory (calculated by 4.9MB)
- Sampling: 30 sec. or 1 min.
- \* Max. recording time = (Max. capacity÷Record length) x Sampling interval

Setting items	Model	Record length (Byte)	Max. recording time (reference value): Approx. (day)	
			Sampling 30 sec.	Sampling 1 min.
Temperature / humidity setting	GS-TH	14	127	254
3-axis acceleration / temperature measurement	GS-3AT	12	148	297
4ch voltage / temperature measurement	GS-4VT	22	81	162
4ch thermistor temperature measurement	GS-4TSR	38	46	93
Illuminance / ultraviolet measurement	GS-LXUV	16	111	223
AC current / power measurement	GS-DPA-AC	20	89	178
CO2 measurement	GS-CO2	6	297	594
Temperature / humidity + CO2 measurement	GS-TH+GS-CO2	16	111	223
Temperature / humidity + illuminance / ultraviolet measurement	GS-TH+GS-LXUV	18	68	137
CO2 + illuminance / ultraviolet measurement	GS-CO2+GS-LXUV	26	99	198

**TRIGGER**

Set the data recording start/stop conditions.

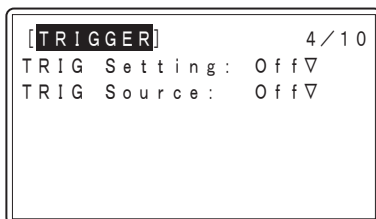

- TRIG Setting .....Set the recording start/stop conditions.

TRIG Setting	Off	Pressing the [START/STOP] key on this module will start/stop recording.
	Start	The recording will start with the trigger source conditions after pressing the [START/STOP] key. The recording will stop after pressing the [START/STOP] key.
	Stop	The recording will start after pressing the [START/STOP] key and will be stopped with the trigger source conditions.

- TRIG Source .....Set the trigger conditions.

TRIG Source	Off	
	Alarm	Operates when alarm occurs.
	Date/Time	Operates with the set date and time.

## ALARM

Set the conditions which the alarm information is sent.

(The settings vary depending on the module).

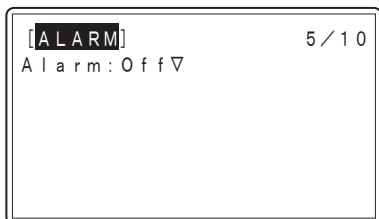

Alarm	Off
Level	Determine the conditions with the numerical setting.

## I/F

The GL100-WL only can be set.

\* When using the GL100-N, this cannot be set.

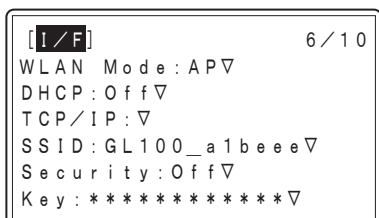

- WLAN Mode .....Set the identifier of the access point.

Off	This is the setting when the wireless function is not used.
Access point	Base unit (When the base unit receives the connection request from the computers on the communication network, it intermediates the communication to the network.)
Station	Set the child unit.

- DHCP .....IP address is automatically allocated.

### Access point

Set to On when you want to automatically allocate the IP address to the wireless LAN child unit (PC, smartphone, or tablet, etc.) connected to the GL100. Conversely, set to Off when setting IP address to the child unit without allocating it.

### Station

When the wireless LAN base unit to be connected has DHCP function, by enabling the function, IP address is automatically allocated to the base unit. When the DHCP function is disabled, IP address is required to manually allocate in the TCP/IP page.

DHCP	Off, On
------	---------

- TCP/IP .....Set the communication protocol of IP Address, Subnet Mask, and Gateway. (The values are an example.)

IP address	192.168.***.***
Subnet mask	255.255.255.000
Gateway	192.168.***.***

- SSID .....This is the identification ID of wireless LAN.

The wireless LAN child unit to be connected to the GL100 is required to set with respect to the connection to this SSID. When operating the child unit in the access point mode, it is possible to use it without modification.

- Security ..... Wireless LAN connection is encrypted for security.

Through the settings other than Off, a third party who does not know the key is not able to connect to the GL100-WL. Usually use the WPA or WPA2.

\* In the case of the station, enter the security scheme and encryption key.

Auto	WPA/WPA2 is automatically identified. This is not used in access point mode.
Off	Encryption is disabled.
WEP	This is a simple encryption method. Set the 13-character key.
WPA	This is more robust encryption scheme than WEP. Set the 8 to 63-character key.
WPA2	

- Key ..... Identification of the base unit when connecting into wireless LAN.

Key	Set the key in accordance with the security settings.
-----	---

**Tip of wireless LAN settings**

Wireless LAN function is supported in the GL100-WL only.

The GL100-WL has two modes of “Access point” and “Station”.

The functions, connectable module, and operating environment of the “Access point” and “Station” are not same.

**Access point (operated as base unit)**

When 1:1 wireless LAN connection (between the GL100 and PC/smartphone/tablet) is enabled, the following modules and operating environment are required.

- PC or Smartphone that can be connected to the wireless LAN with the dedicated software.

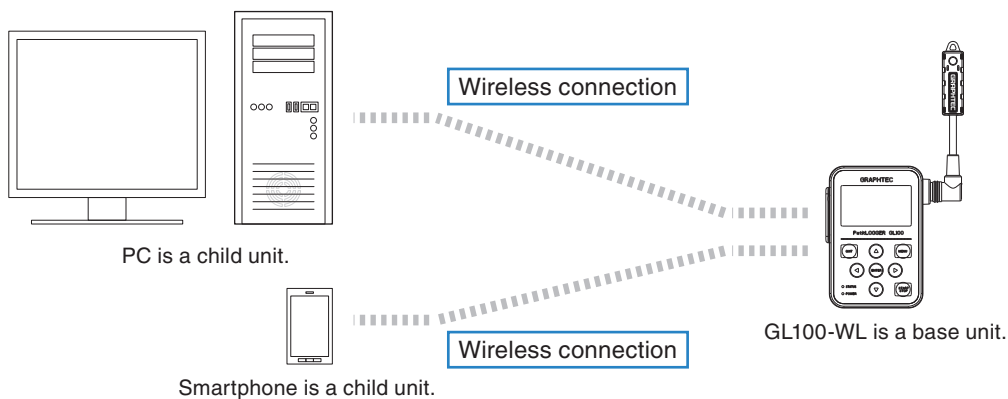

**Station (operated as child unit):**

When connecting PC to the commercially available wireless LAN base unit and controlling multiple GL100s from PC, the following modules and operating environment are required.

- PC or Smartphone that can be connected to the wireless LAN with the dedicated software.
- Wireless LAN base unit (device with Wi-Fi-certified wireless LAN base unit function)
- Internet connecting environment when you want to connect the Internet (Internet provider agreement or mobile carrier agreement, etc.)
- Internet connecting and e-mail sending/receiving environments when you want to send/receive e-mail (E-mail and web mail for Internet provider)

\* SMTP and POP3 are required.

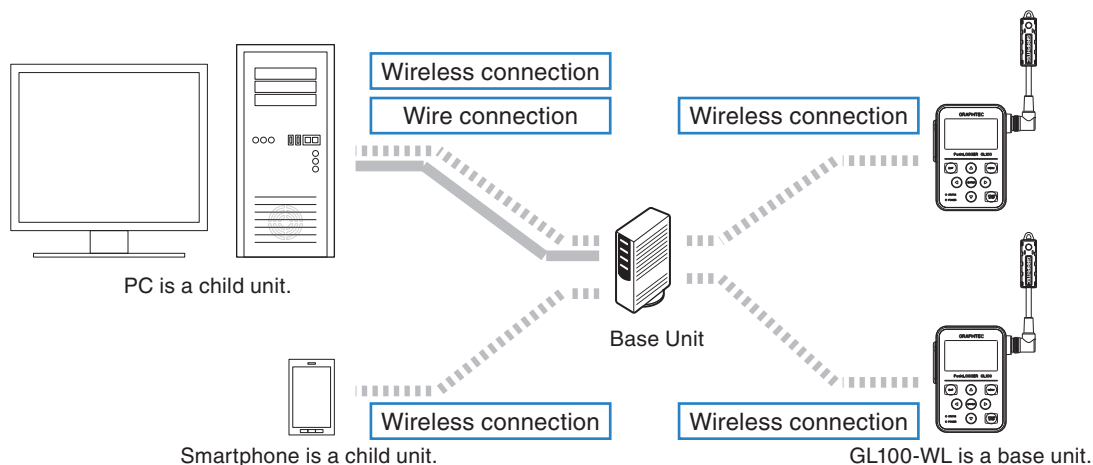

Various settings can be set in the GL100. In addition, there is a way to set by using the GL100-Network\_Config software included on the CD-ROM. For the usage and operation, refer to the Help.

**MAIL**

This can be set for the GL100-WL only.

\* When using the GL100-N, this cannot be set.

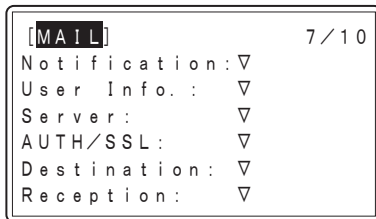

- Notification ..... The information sent by e-mail can be set to On/Off.

Alarm notification	The alarm information is sent when the alarm occurs.
Battery LOW	The battery information is sent when battery level is low.
Radio field intensity LOW	The radio information is sent when radio field intensity is low.
Disk full	The memory information is sent when remaining capacity of SD card is low.

- User Info. .... Set the mail address, etc. of GL100.

Mail address	Set the e-mail destination address within 63 characters. ****@***.co.jp
Server name	Set the user account names of receiving and sending servers. To set individually, use the GL100-Network_Config software.
Password	Set the user passwords of receiving and sending servers. To set individually, use the GL100-Network_Config software.

- Server ..... Set the mail sending server of the GL100.

POP Server	Set the mail receiving server.
POP Port	Set the port number in accordance with the POPS of AUTH/SSL. OFF: 110 STARTTLS: 143 OVERSSL: 993 For detailed settings, follow the POP server available.
SMTP Server	Set the mail sending server.
SMTP Port	Set the port number in accordance with the AUTH/SSL. OFF: 25 STARTTLS: 587 OVERSSL: 465 For detailed settings, follow the SMTP server available.

- AUTH/SSL ..... Set the e-mail authentication and encryption.

AUTH (SMTP)	Off, POP, SMTP-AUTH
SMTP-AUTH	PLAIN, CRAM-MDS
POPS	Off, STARTTLS, OVERSSL
SMTPS	Off, STARTTLS, OVERSSL

- Destination .....Set the mail destination and subject.

TO	****@***.co.jp Set within 63 characters.
CC	aaaaa@***.co.jp Set within 63 characters.
CC	bbbbbb@***.co.jp Set within 63 characters.
CC	ccccc@***.co.jp Set within 63 characters.
CC	dddddd@***.co.jp Set within 63 characters.
Subject	Set the subject within 63 characters.

- Reception .....Set the mail receiving time interval and mail data processing.

Receiving interval	Set the receiving interval to 1 to1440 min.
Sending test	The test results are displayed after performing the sending test.
Receiving test	The test results are displayed after performing the receiving test.

### OTHER-1

The displayed information varies depending on the module.

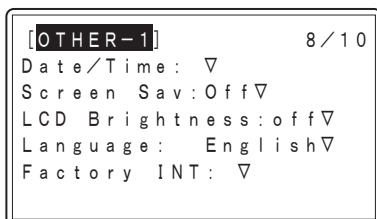

- Date/Time .....Always check it after power-on.

Mode	YY:MM:DD, DD:MM:YY
Date	2014-07-01, 07-01-2014
Time	10:10:00 (Hour:Minute:Second)

- Screen Sav.....Set the time to turn off the screen when the GL100 is not in operation.

Screen Saver	Off, 2, 5, 0, 20, 30, 60 min.
--------------	-------------------------------

**CAUTION** There is no screen display while the screen saver is running, but the Power lamp (green) flashes. In such cases, the screen is displayed by pressing any key.  
When the Power lamp (green) does not flash, the GL100 is in Power OFF state. In such cases, hold down [MENU] key.

- LCD Brightness .....Adjust the brightness of LCD backlight.

LCD brightness	Off, Dark, Middle, Bright
----------------	---------------------------

- Language.....The display language can be switched to English or Japanese. (The default display language is English.)

Language	English or Japanese
----------	---------------------

- Factory INT .....Return to the factory settings.

All settings will be reset, so please use caution.

Yes: (ENTER)	When [ENTER] key is pressed, the settings are initialized.
No: (QUIT)	To quit this screen without changing, press [QUIT] key.



## OTHER-2

The displayed information varies depending on the module.

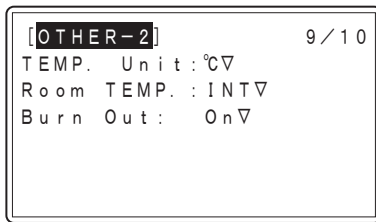

- TEMP. Unit .....Set for GS-4VT, GS-3AT, and GS-TH.

TEMP. Unit	Switch the temperature unit to Celsius (°C) or Fahrenheit (°F).
------------	---

- Room TEMP. ....Set for GS-4VT.

Room TEMP.	Switch to room temperature compensation or external compensation
------------	--

- Burn Out .....Set for GS-4VT.

Burn Out	Set the sensor disconnection display for the thermocouple. When the sensor is not connected or disconnected, the connection state is displayed in the screen.
----------	---

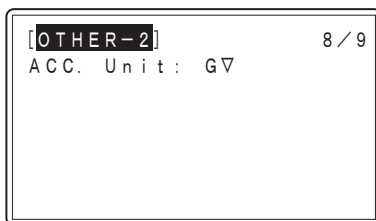

- ACC. Unit .....Set for GS-3AT.

ACC. Unit	Switch the acceleration unit to G or m/s <sup>2</sup> .
-----------	---

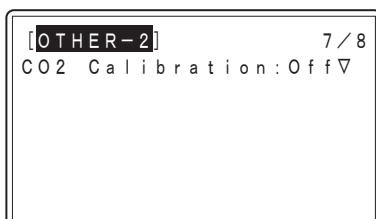

- CO2 Calibration .....Set for GS-CO2.

CO2 Calibration	Calibrate the minimum value within a certain period of time with respect to the reference value. This is useful in the environment CO <sub>2</sub> concentration is low.
-----------------	--

When the settings are complete, press [QUIT] key to display the free-running screen.

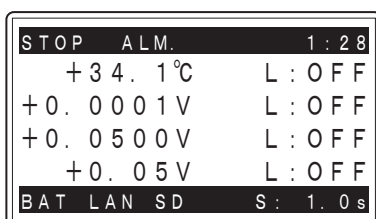

## 5. Start or stop the measurement

### Measurement start operation

Preparation of 1 to 4 sections is complete, press the [START/STOP] key.

The "ARMED" is displayed until the trigger condition is satisfied from "STOP".

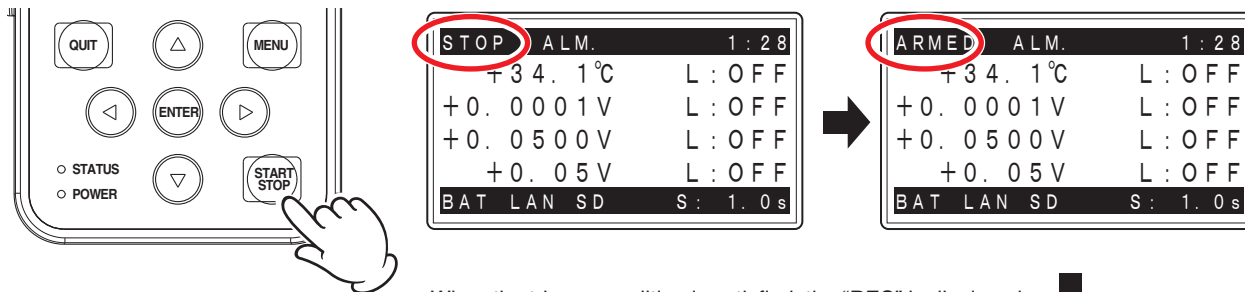

When the trigger condition is satisfied, the "REC" is displayed.

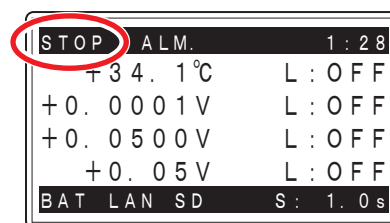

### Operation display during measurement

The module's status is shown with the lamp display.

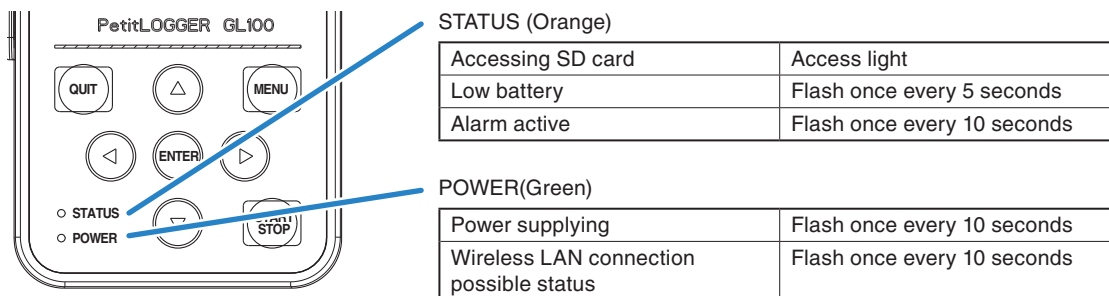

- CAUTION**
- When accessing an SD card, do not remove the SD card. The data may not write properly or the SD card may be damaged.
  - When "low battery" is displayed, replace the battery or connect the USB interface to supply power as soon as possible. Caution: Batteries cannot be replaced when recording data. Replace them after the recording has finished.

**Measurement stop operation**

To stop recording, press the [START/STOP] key.

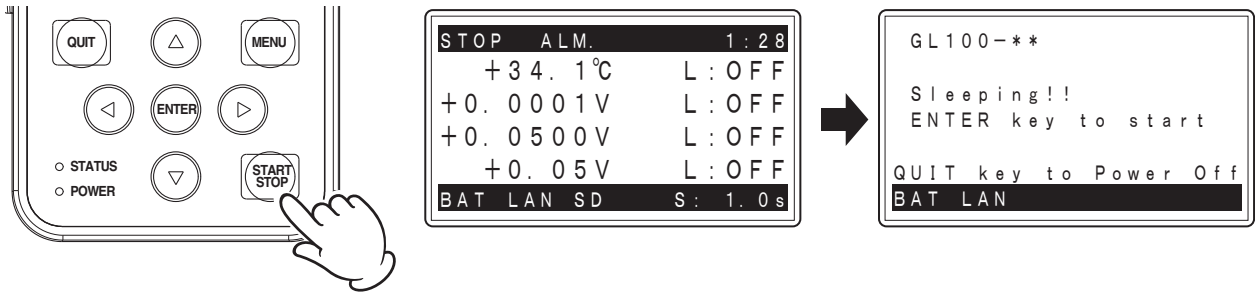

**TIP** Since the measured data is recorded in file until the 'Sleeping!!' screen is displayed by pressing the [STOP] key, it takes some time before the screen is switched. Press [ENTER] key to return to the free-running screen.

Press [ENTER] key to return to the free-running screen.

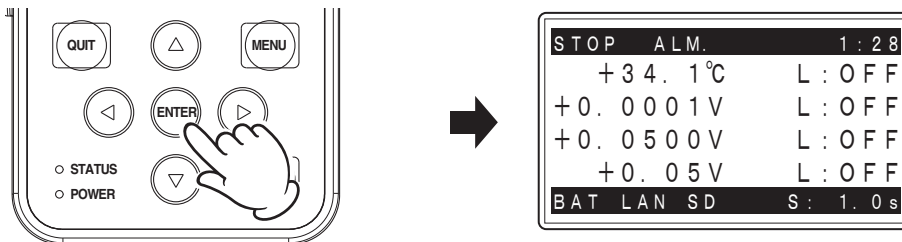

## 6. How to confirm the recorded data

When you want to confirm the recorded data, replay the data on PC or Smartphone with the dedicated software.

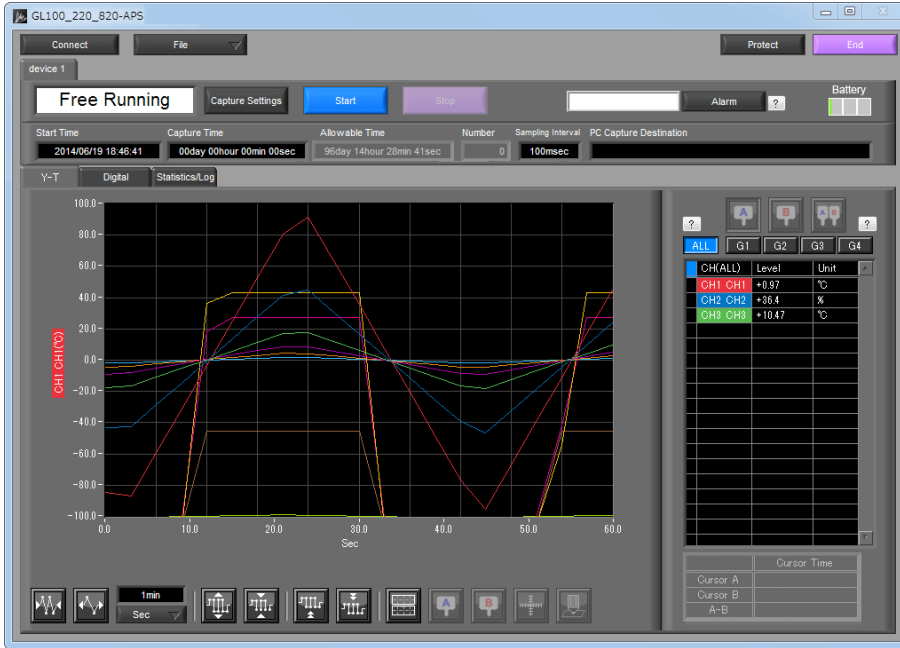

(1) Online data confirmation using USB I/F

Connect between the PC and GL100-N/GL100-WL using USB cable.

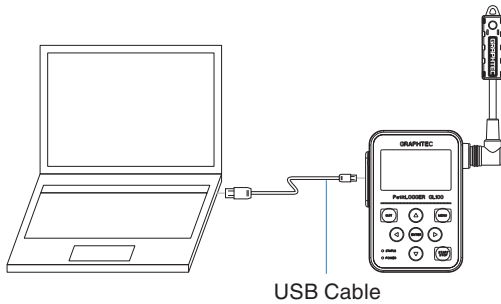

The recorded data can be confirmed by starting the application software and selecting the memory (internal memory or SD card).

(2) Direct data confirmation by inserting SD card

The recorded data can be confirmed by inserting the recorded SD card into the SD card slot on the PC and selecting the SD card using the application software.

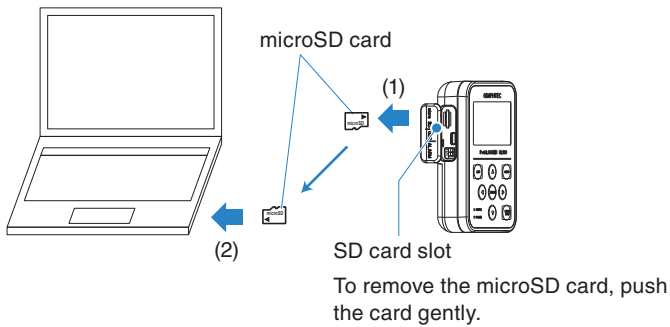

(3) Data confirmation on PC through wireless LAN connection

In the case of wireless LAN connection, this function is disabled unless the communicating conditions are established.

The "I/F" and "MAIL" in "3.4 Measurement Procedure" are required to set. Connect between the GL100 and PC and then set them using the attached GL100-Network\_Config software.

- Direct setting of the GL100

[I/F Setting]

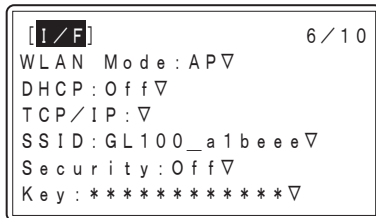

[MAIL Setting]

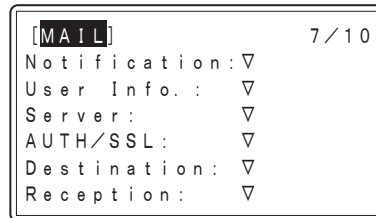

- Wireless LAN and Mail settings using the GL100-Network Config.

Using the "GL100-Network\_Config" software included on the attached CD-ROM, perform various settings with reference to Help.

Date/Time adjustment, wireless LAN setting, and mail send/receive setting, etc. can be performed.

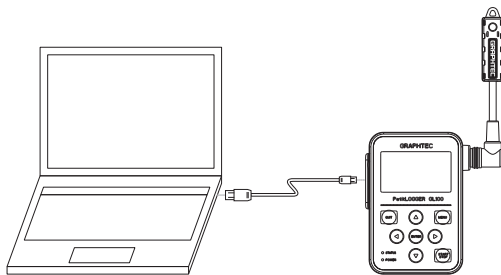

(4) Smart device application software

Using the smart device application software (iOS/Android), the data during recording can be checked and controlled.

The software is available from AppStore (iOS) or GooglePlay (Android).

Digital display, waveform display (Available only when replaying.)

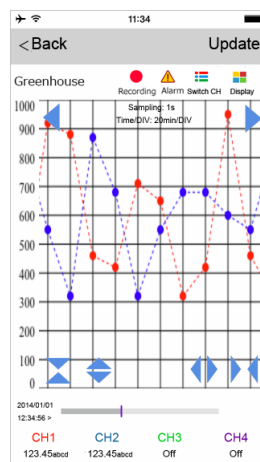
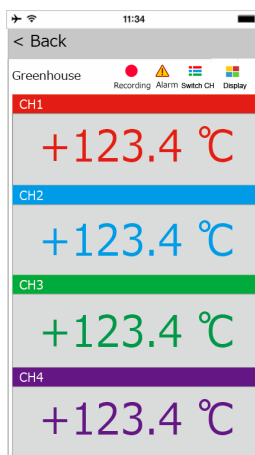



# ***CHAPTER 4 Specification***

---

This chapter describes the basic specifications for the GL100.

## ***Product Summary***

- 4.1 Standard Specifications***
- 4.2 Standard Specifications (Module)***
- 4.3 Specifications of Application Software***

## 4.1 Standard Specifications

### GL100-N/GL100-WL

Item		Contents
Input channel number		This depends on the type of module to be used.
Input terminal shape		
Input method		
External input/output		Alarm output 1 channel
PC I/F		USB (Micro-B connector) Wireless LAN (GL100-WL only) * ON/OFF can be set (It is set to ON at the factory.)
Built-in memory device		Main Memory: approximate 4.9M Byte External memory: microSD card (Please use a commercially available product) * 1 file cannot exceed 1.9GB. * A microSD card which supports sleep mode is recommended TS4GUSDHC4 (Transcend) etc.
Backup function		Setup conditions: EEPROM Clock: Backup capacitor Time need for backup during battery exchange: approx. 10 hours (at 23°C)
Monitor		Graphic monochrome display (128×64 dot)
Display contents		Measured values, settings, etc. Note: Recorded data cannot be viewed on this module. Please use the included application software.
Wireless LAN (GL100-WL only)		Standards: IEEE 802.11b Communication distance: approx. 40 m * It depends on the surrounding obstacles and environmental conditions Real-time data transfer rate: 500 ms maximum
Functions	USB I/F	Real-time display, measured data readout, module settings (PC application)
	Wireless LAN	Real-time display, measurement data readout, module settings (Android / iOS smartphone application), Email reception function Note: GL100-WL only
Alarm output type		Insulation switching type by photo coupler Rating: 30V, 50 mA (power dissipation 150 mW)
Memory content		Recorded Data
Simple waterproof body		IP54 <sup>†</sup>
Vibration proof		Automobile parts Type 1 Class A equivalent
Rated power		GL100-N: Max. 3.0VA, GL100-WL: Max. 3.5VA * It depends on the type of module to be used.
Power supply		AA alkaline batteries 2 pcs., USB Bus power (5V 200mA or more) * USB cable for Micro B-A is included. Batteries and USB AC adapter (5V 1A or more) are not included.
Usage environment		-10 to 50°C, 80% RH or less (non-condensing)
External dimensions [W×D×H] (approximate)		66 × 100 × 27 mm (not including protruding parts)
Weight (approximate)		GL100-N : 125 g, GL100-WL : 130 g

\*1: The IP54 can only be used when the GL100 and module are connected, and the connector cover and battery cover are closed. We recommend replacing the packing periodically.



**External View**

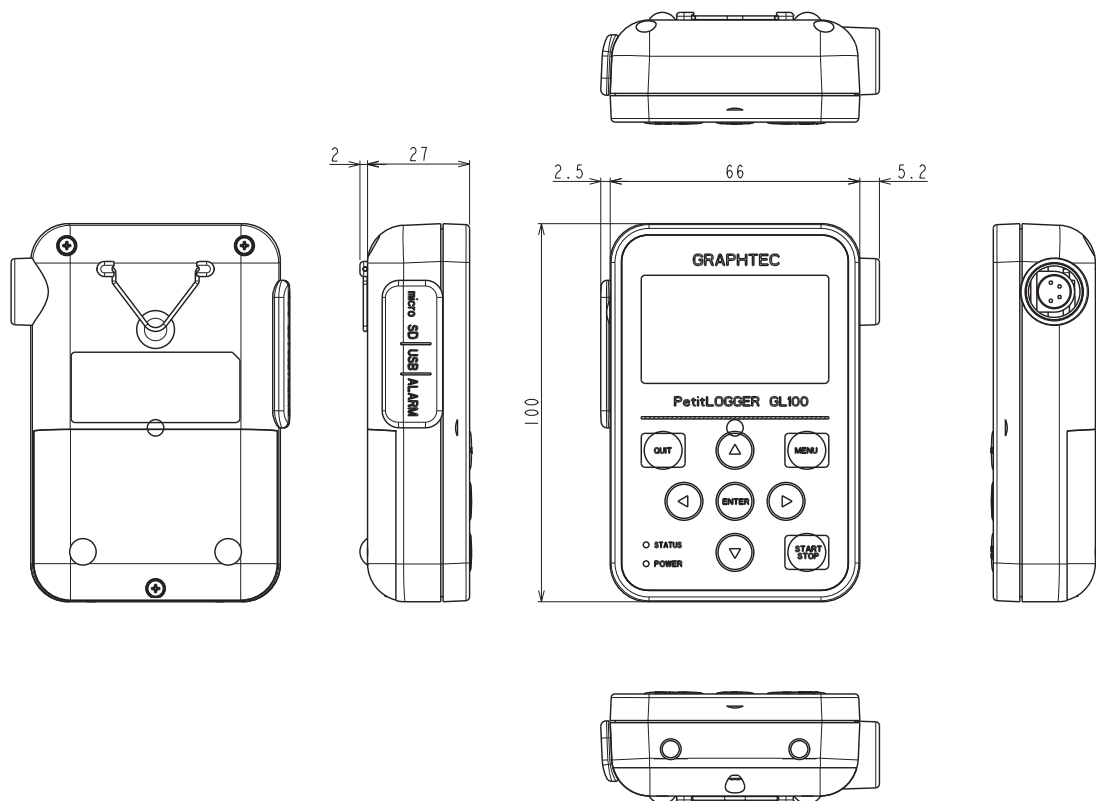

Unit: mm  
 Dimensional accuracy:  $\pm 2$  mm

## 4.2 Standard Specifications (Module)

### 4ch Voltage / Temperature Terminal (GS-4VT): Optional

Item	Contents
Measurement data	Voltage / Temperature/Logic, Pulse count (Instant, Accumulation)
Measurement channels	Voltage/Temperature 4 channels Logic/Pulse count 4 channels
Input method	Scan system by Photo-MOS relay, All-channel isolated input
Measurement voltage range	20, 50, 100, 200, 500 mV 1, 2, 5, 10, 20, 50V 1-5V F.S.
Measured voltage accuracy	0.15 % of F.S.
Input resistance	1M $\Omega$ $\pm$ 5%
Temperature coefficient	Gain: $\pm$ 0.01 % of F.S./ $^{\circ}$ C Zero: $\pm$ 0.02 % of F.S./ $^{\circ}$ C
Allowable signal source resistance	300 $\Omega$ or less
Maximum input voltage	Input terminal + / - interval : 60Vp-p Input terminal / Input terminal interval : 60Vp-p Input terminal / GND interval : 60Vp-p
Withstand voltage	Input terminal / Input terminal interval : 350 Vp-p 1 min. Input terminal / GND interval : 350Vp-p 1 min.
Insulation resistance	Input terminal / GND interval : 50M $\Omega$ or more (at DC500V)
Common mode rejection ratio	90 dB or more (50/60 Hz signal source 300 $\Omega$ or less)
Noise	48 db or more (+/- at short)
Measurement temperature range	<Thermocouple> K -200 to 1370 $^{\circ}$ C T -200 to 400 $^{\circ}$ C
Measured temperature accuracy	<K-type thermocouple> -200 $\leq$ TS $\leq$ -100 $\pm$ (0.05% of rdg +2.0 $^{\circ}$ C) -100<TS $\leq$ 1370 $^{\circ}$ C $\pm$ (0.05% of rdg +1.0 $^{\circ}$ C) <T-type thermocouple> -200 $\leq$ TS $\leq$ -100 $\pm$ (0.1% of rdg +1.5 $^{\circ}$ C) -100<TS $\leq$ 400 $^{\circ}$ C $\pm$ (0.1% of rdg +0.5 $^{\circ}$ C) Reference junction compensation accuracy : $\pm$ 0.5 $^{\circ}$ C
Logic/Pulse Input	Input voltage range: 0 to +24V (One line ground input) Input signal: No-voltage contact (a contact, b contact, NO, NC) Open collector, voltage input Input threshold voltage: approx. +2.5V Hysteresis: approx. 0.5 V (+2 to -2.5V)
Pulse measurement range	Instant : max. 200C / Sampling Accumulation: max. 65535C
Room temperature compensation	ON / OFF
Temperature uni	Select from $^{\circ}$ C (Celsius) / $^{\circ}$ F (Fahrenheit)
Sampling interval	0.5, 1, 2, 5, 10, 20, 30 sec. 1, 2, 5, 10, 20, 30, 60 min.
Alarm	OFF / Level
Cable Length	Approximate 20 cm
Usage environment	-10 to 50 $^{\circ}$ C, 80% RH or less (non-condensing)
External dimensions [WxDxH] (approximate)	46 x 66 x 35.5 mm (not including protruding parts)
Weight (approximate)	85 g

**External View**

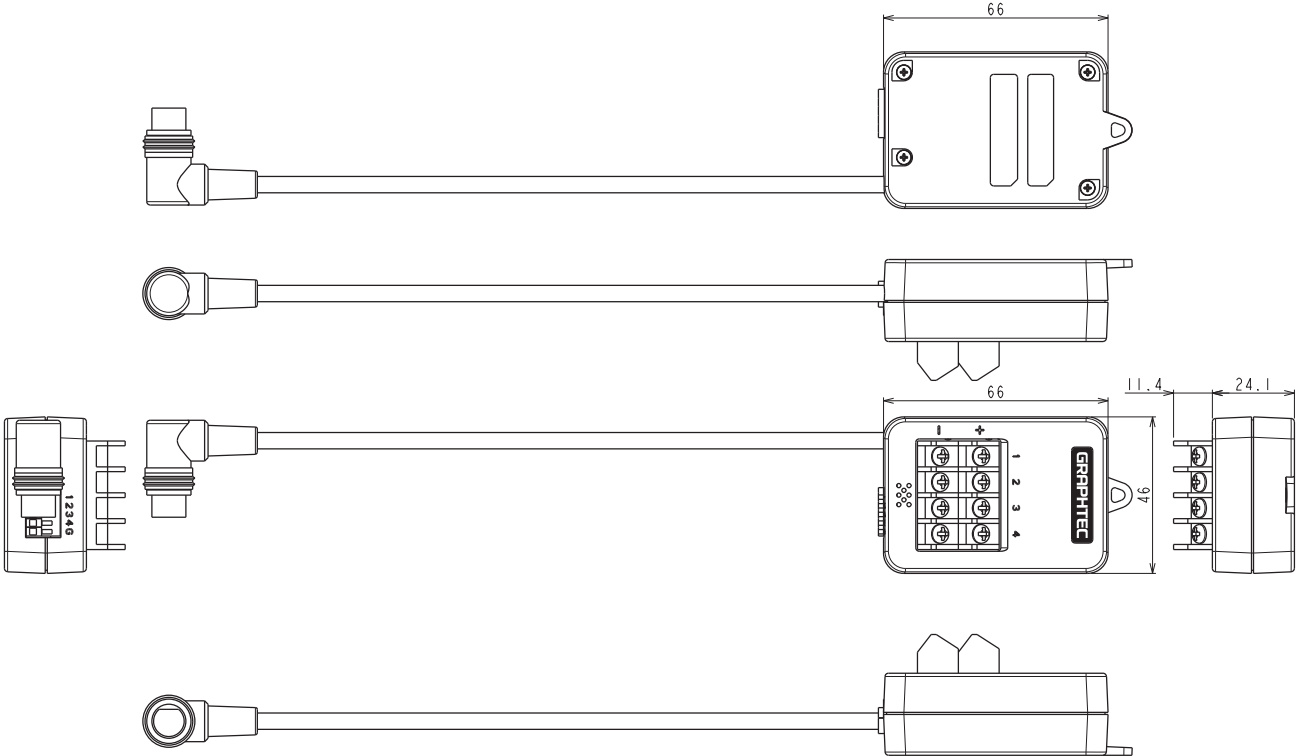

Unit: mm  
Dimensional accuracy: ±2 mm

**3-axis Acceleration / Temperature Sensor (GS-3AT): Optional**

Item	Contents
Measurement data	Acceleration (3-axis) / Temperature
Acceleration range	$\pm 2$ G (20m/s <sup>2</sup> ), $\pm 5$ G (50m/s <sup>2</sup> ), $\pm 10$ G (100m/s <sup>2</sup> )
Measured acceleration accuracy(Non-linearity)	$\pm 2\%$ of F.S.
Band	0 to 100Hz
Noise	25 mGrms
Measurement temperature range	-10 to 50°C (14°F to 122°F)
Measured temperature accuracy	$-10 \leq TS \leq 50 \pm 1.0$ (°C)
Response time (temperature)	Approx. 300 sec.
Measurement mode	Memory mode and Direct mode
Memory capacity (Memory mode)	16, 32, 64, 128 k sample
Pre-trigger (Memory mode)	OFF / 10, 25, 50, 100%
Sampling interval	<Memory mode> 5, 10, 20, 50, 100 ms <Direct mode> 0.5, 1, 2, 5, 10, 20, 30 sec. 1, 2, 5, 10, 20, 30, 60 min.
Alarm	OFF / Level
ADJUST function	Set / Reset Note: This function will set the current static acceleration value to zero.
Waterproof sensor	IP54
Cable length	Approximate 20 cm
Usage environment	-10 to 50°C, 80% RH or less (non-condensing)
External dimensions [WxDxH] (approximate)	51 × 36 × 19.5 mm (not including protruding parts)
Weight (approximate)	64 g

**External View**

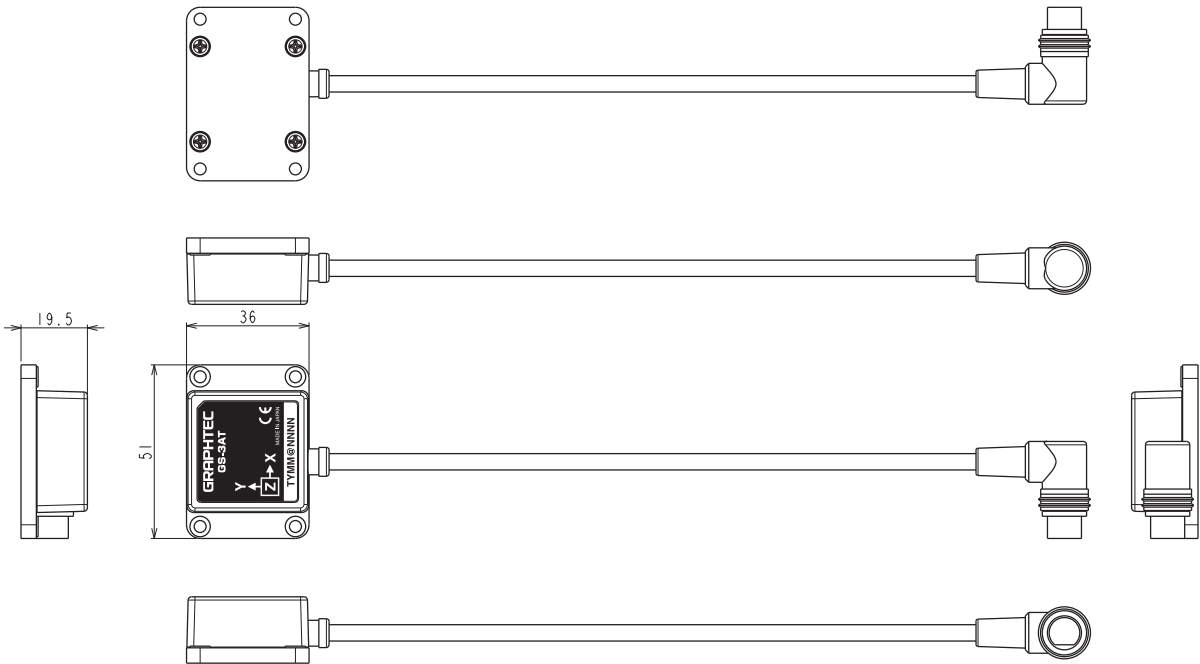

Unit: mm  
Dimensional accuracy: ±2 mm

**4ch Thermistor Terminal (GS-4TSR): Optional**

Item	Contents
Measurement data	Temperature/Logic, Pulse count (Instant, Accumulation)
Measurement channels	Temperature 4 channels Logic/Pulse count 4 channels
Input method	Scan method, non-isolated input (Thermistor input)
Temperature range	Type A: -40°C to 105°C (GS-103AT-4P) Type J: -40°C to 120°C (GS-103JT-4P)
Measured temperature accuracy	<Main module>      -40 ≤ TS < 0 ±0.7 (°C) 0 ≤ TS ≤ 35 ±0.2 (°C) 35 < TS ≤ 70 ±0.4 (°C) 70 < TS ≤ 120 ±1.0 (°C) <Thermistor sensor> ±0.4°C(Typical value)
Logic / Pulse Input	Input voltage range: 0 to +24V (One line ground input) Input signal:   No-voltage contact (a contact, b contact, NO, NC), Open collector, voltage input Threshold level: approx. +2.5V Hysteresis: approx. 0.5V (+2 to +2.5V)
Pulse measurement range	Instant : Max. 200C / Sampling Accumulation: Max. 65535C
Temperature unit	Select from °C (Celsius) / °F (Fahrenheit)
Sampling interval	0.5, 1, 2, 5, 10, 20, 30 sec. 1, 2, 5, 10, 20, 30, 60 min.
Triggers	Start trigger : OFF, LEVEL, ALARAM, DATE Stop trigger : OFF, LEVEL, ALARAM
Alarm	OFF / Level
Cable length	Approximate 20 cm
Usage environment	-10 to 50°C, 80% RH ore less (non-condensing)
External dimensions [W×D×H] (approximate)	46 × 66 × 35.5 mm (not including protruding parts)
Weight (approximate)	83 g

**External View**

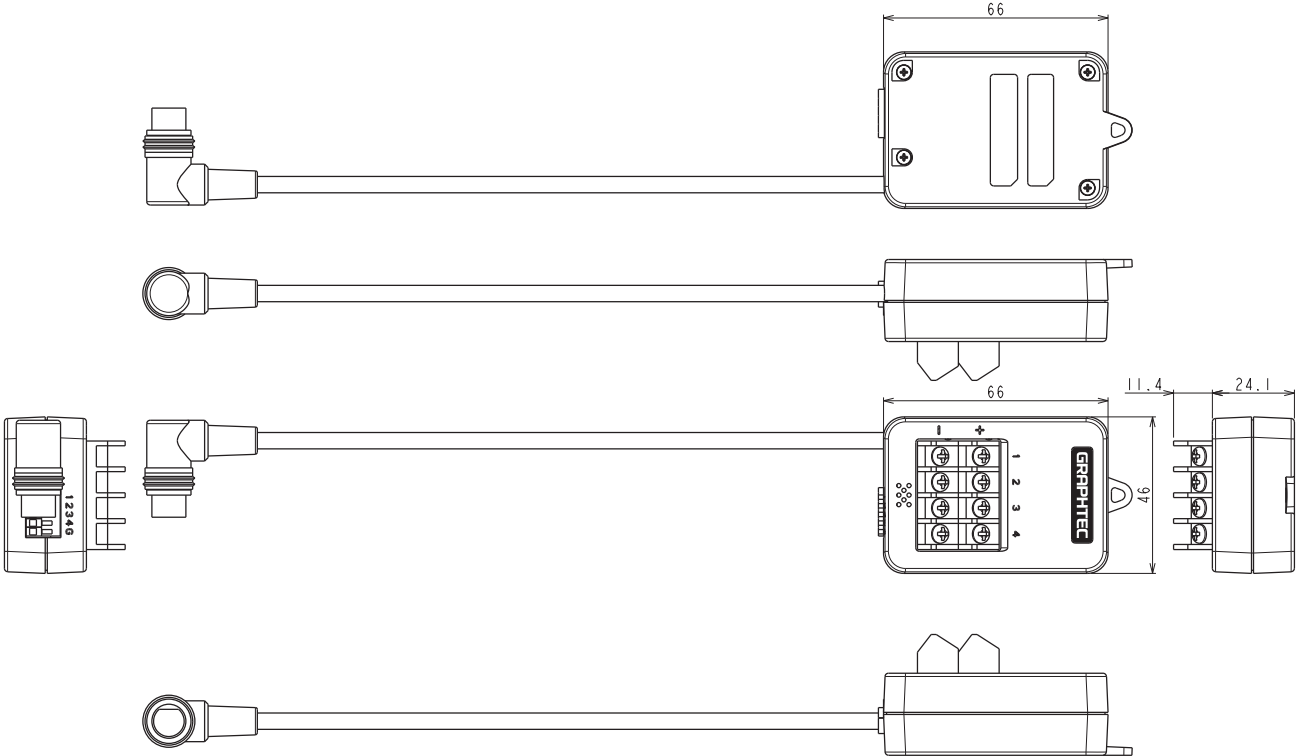

Unit: mm  
Dimensional accuracy: ±2 mm

**Adapter for AC Current Sensor (GS-DPA-AC): Optional**

Item	Contents
Measurement data	Current, power, accumulated power * The accumulated power is displayed only when recording.
Connectable sensors	50A AC Current Sensor (GS-AC50A) 100A AC Current Sensor (GS-AC100A) 200A AC Current Sensor (GS-AC200A) * This is optional.
Measurement channel	Connectable sensor: up to 2 channels
Measured current accuracy	<Module + Sensor> ±2.0% FS ± 1 digit Ambient temperature 23°C, Rated input, Rated frequency
Frequency to be measured	50Hz / 60Hz
Applicable circuit	Single-phase 2-wire Single-phase 3-wire 3-phase 3-wire
Measured value display function	Current and power (Instantaneous power or accumulated power consumption)
Primary rated current	50A AC Current Sensor: 50A 100A AC Current Sensor: 100A 200A AC Current Sensor: 200A
Withstand voltage	Between case and all input/output terminals interval AC1000V, 50/60Hz, 1 min.
Sampling interval	0.5, 1, 2, 5, 10, 20, 30 sec. 1, 2, 5, 10, 20, 30, 60 min.
Alarm	OFF / Level
Cable length	Approx. 20 cm
Usage environment	-10 to 50°C, 80% RH or less (non-condensing)
External dimensions [W×D×H] (approximate)	46 × 66 × 27.4 mm (not including protruding parts)
Weight (approximate)	55 g

**AC Current Sensor Specifications**

The AC Current Sensor has the specifications below. Be careful when handling it.

Item	Contents
Max. allowable current	GS-AC50A: 100Arms GS-AC100A: 200Arms GS-AC200A: 300Arms
Withstand voltage	AC2200V, 1 min. (between external case and output terminals)
Insulation resistance	DC500V, 100MΩ or more (between external case and output terminals)
Window diameter	GS-AC50A: φ10 mm GS-AC100A: φ16 mm GS-AC200A: φ24 mm
Operating temperature and humidity	-10 to 50°C, 80% RH or less (non-condensing)
Cable length	Approx. 20 cm
External dimensions [W×D×H] (approximate)	GS-AC50A: 26.4 x 25.5 x 43.3 mm GS-AC100A: 27.4 x 30.5 x 46.2 mm GS-AC200A: 48.4 x 35 x 40 mm



**External View**

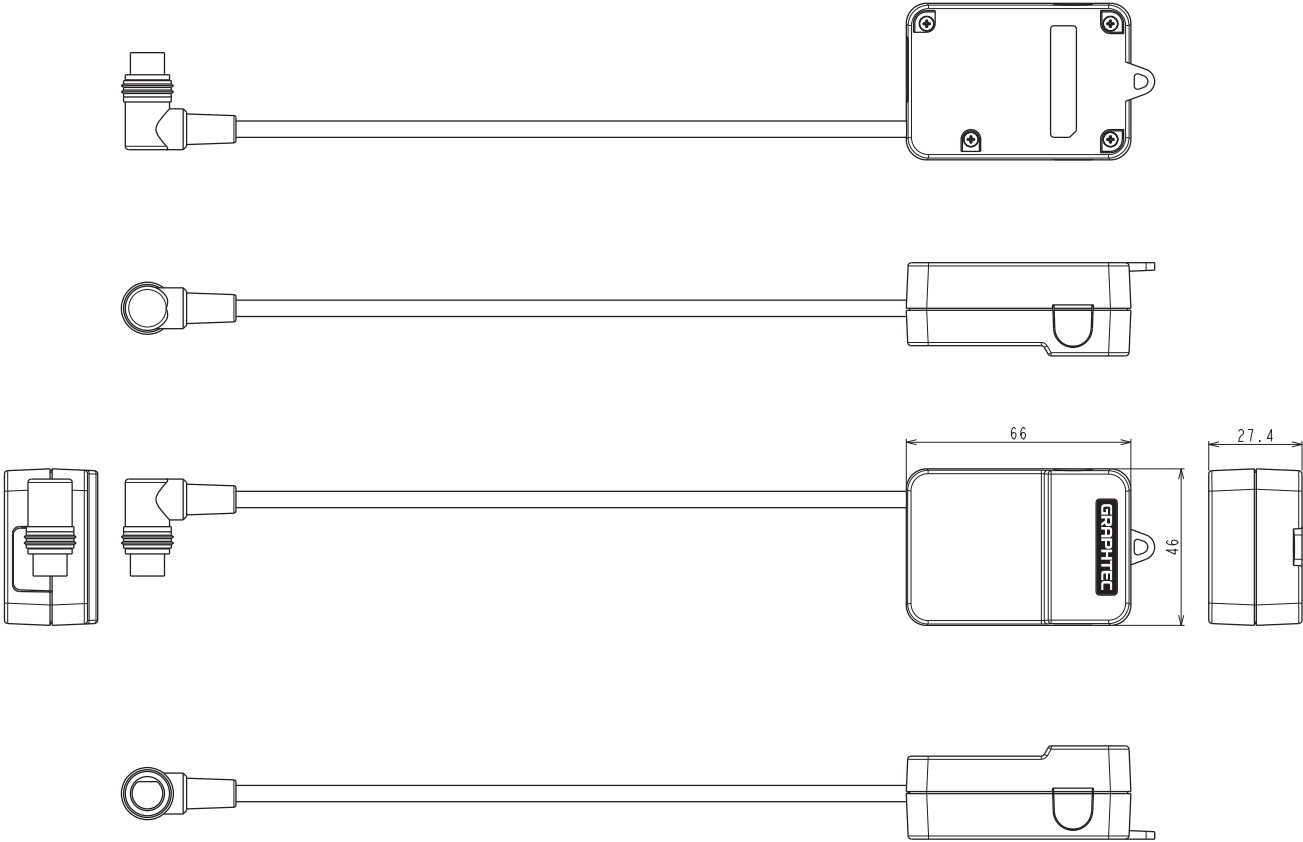

Unit: mm  
Dimensional accuracy: ±2 mm

**Illumination / Ultraviolet Sensor (GS-LXUV): Optional**

Item	Contents
Measurement data	Illuminance, ultraviolet, accumulated illuminance, accumulated ultraviolet intensity * The accumulated illuminance and ultraviolet intensity are displayed only when recording.
Measurement channel	Illuminance: 1 channel UV intensity: 1 channel
Measurement range	Illuminance: 0 to 200k lx UV intensity: 0 to 30 mW / cm <sup>2</sup>
Measurement accuracy	Illuminance: ±5% (at 25°C) Ultraviolet intensity: ±5% (at 25°C)
Spectral sensitivity	Illuminance: 400 to 750 nm (peak 560 nm) UV intensity: 260 to 400 nm (peak 370 nm)
Measurement resolution	Illuminance: 0.1 lx UV intensity: 0.001 mW/cm <sup>2</sup>
Responsive	Illuminance: 1 ms or less UV intensity: 1 ms or less
Accumulated function	Accumulated illuminance: 0 to 999,999 k lxh Accumulated UV intensity: 0 to 999,999 mW/cm <sup>2</sup> h
Sampling interval	0.5, 1, 2, 5, 10, 20, 30 sec. 1, 2, 5, 10, 20, 30, 60 min.
Alarm	OFF / Level
Cable length	Approximate 20 cm
Usage environment	-10 to 50°C, 80% RH or less (non-condensing)
External dimensions [WxDxH] (approximate)	46 × 66 × 19 mm (not including protruding parts)
Weight (approximate)	65 g

External View

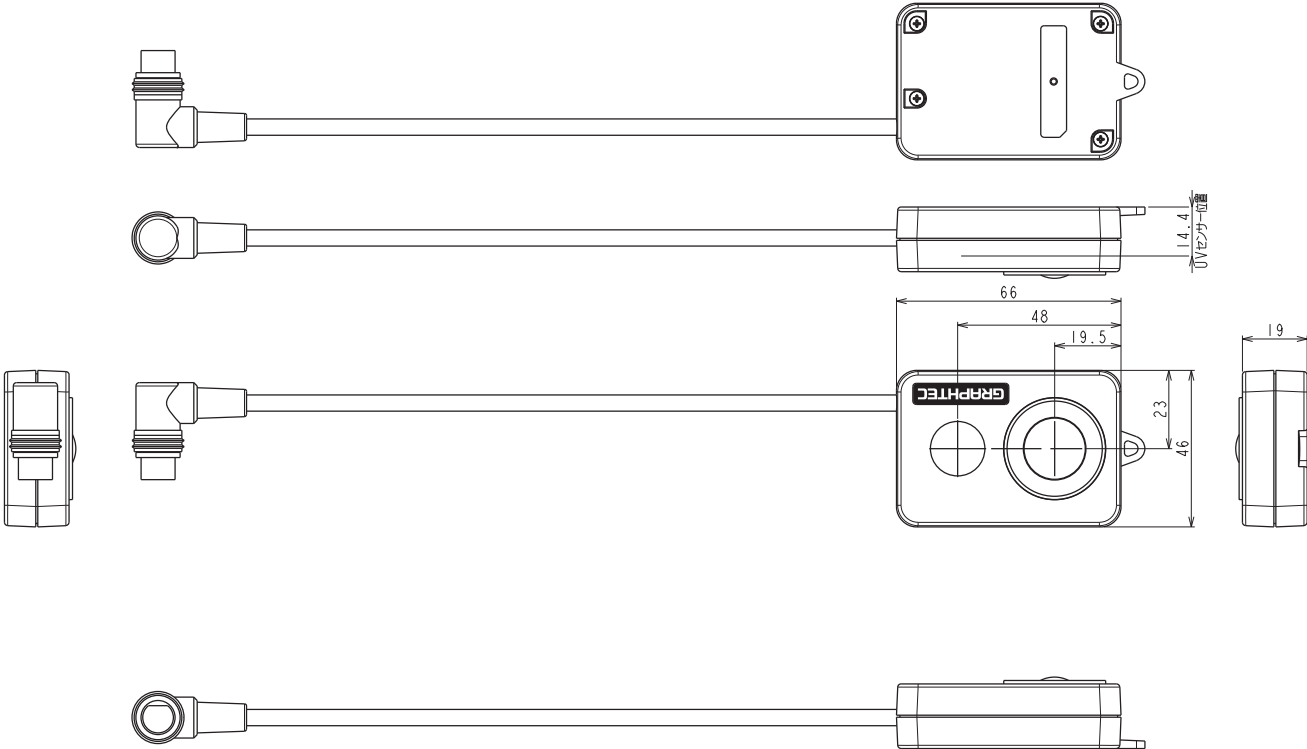

Unit: mm  
Dimensional accuracy: ±2 mm

**CO<sub>2</sub> Sensor (GS-CO2): Optional**

Item	Contents
Sensor method	NDIR system
Measurement data	CO <sub>2</sub> density
Measurement channel	1 channel
Measurement density range	0 to 9999 ppm
Measurement density accuracy	±(5% of rdg + 30 ppm) * Within the range of 0 to 5000 ppm
Responsive	3 minutes or less
Sampling interval	0.5, 1, 2, 5, 10, 20, 30 sec. 1, 2, 5, 10, 20, 30, 60 min. * The processing of sensor is every 2 sec. Even if setting it to 0.5 or 1 sec., the data is processed at the same value (2 sec.).
Alarm	OFF / Level
Cable length	Approximate 20 cm
Usage environment	0 to 50°C, 80% RH or less (non-condensing)
External dimensions [W×D×H] (approximate)	66 × 100 × 24.6 mm (not including protruding parts)
Weight (approximate)	99 g

\* We recommend replacing the module periodically.

**External View**

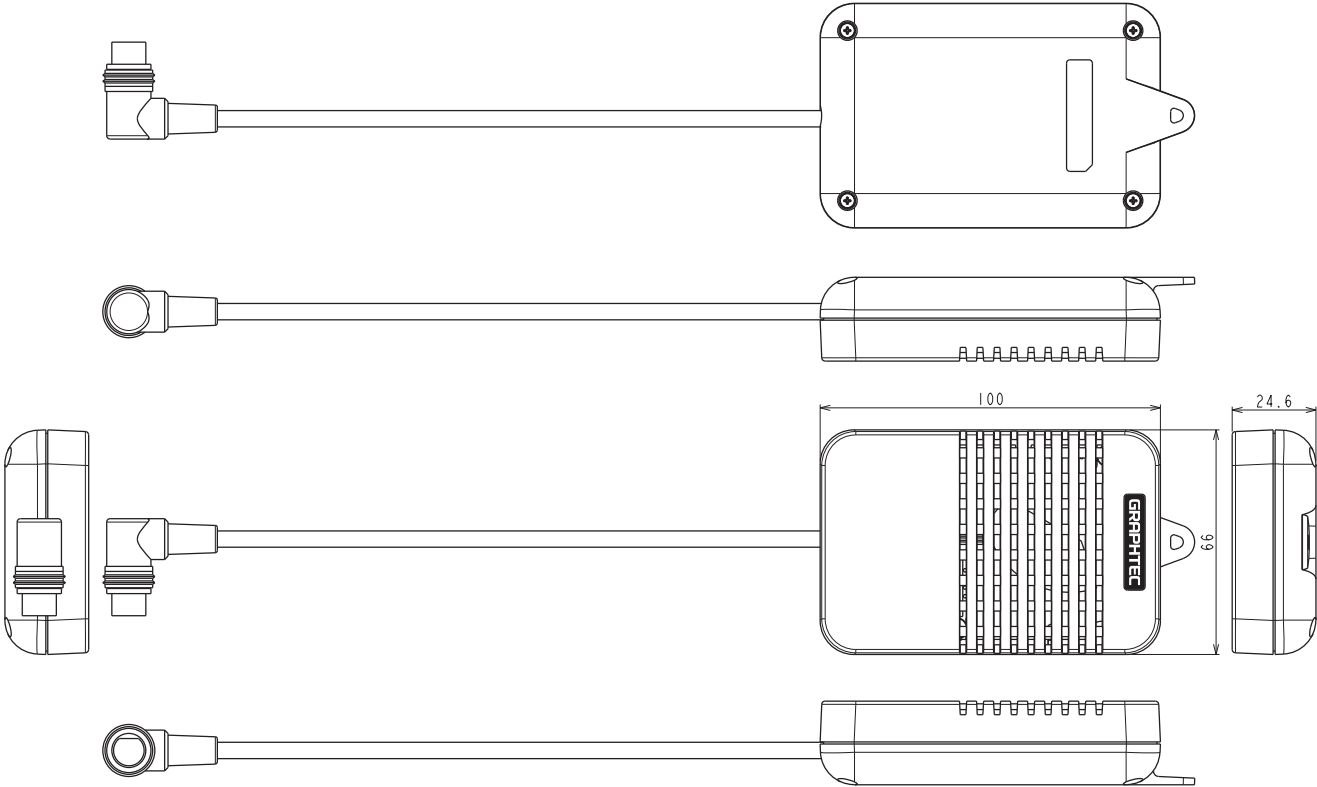

Unit: mm  
Dimensional accuracy: ±2 mm

**Temperature / Humidity Sensor (GS-TH): Optional**

Item	Contents
Measurement data	Temperature, humidity, dew point temperature (calculated value), accumulated temperature * The accumulated temperature is displayed only when recording.
Measurement system	C-MOS Sensor
Measurement temperature range	-20°C to 85°C
Measured temperature accuracy	-20 ≤ TS < 0 ±0.8 (°C) 0 ≤ TS ≤ 60 ±0.5 (°C) 60 < TS ≤ 85 ±0.8 (°C)
Measurement humidity range	0.0 to 100.0% RH
Measured humidity accuracy	25°C 0 ≤ RH < 10 ±10 (%) 10 ≤ RH < 20 ±8 (%) 20 ≤ RH ≤ 80 ±5 (%) 80 < RH ≤ 90 ±8 (%) 90 < RH ≤ 100 ±10 (%)
Response time	Temperature and humidity: 100 sec. (63% response, 25°C Air flow rate 1 m/s) * The sensor's responsiveness is affected by the measured temperature and air flow rate.
Sampling interval	0.5, 1, 2, 5, 10, 20, 30 sec. 1, 2, 5, 10, 20, 30, 60 min.
Alarm	OFF / Level
Waterproof treatment	Sensor unit With waterproof filter
Temperature unit	Select from °C (Celsius) / °F (Fahrenheit)
Usage environment	Within the measurement range of temperature and humidity However, set it to the environment if the GI100 and this sensor are in the same environment.
External dimensions [W×D×H] (approximate)	15 × 45 × 10.2 mm (not including protruding parts)
Weight (approximate)	14 g

\* We recommend replacing the module periodically.

**External View**

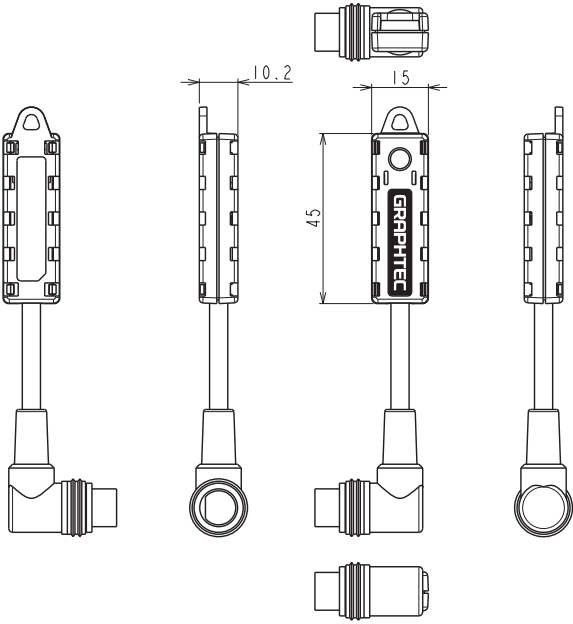

Unit: mm  
Dimensional accuracy: ±2 mm

**GS Branch Adapter(GS-DPA): Optional**

<b>Item</b>	<b>Contents</b>
Number of connectors	2 channels
Connectable sensor	Temperature and humidity sensor (GS-TH) Illumination / ultraviolet sensor (GS-LXUV) CO <sub>2</sub> sensor (GS-CO2)
Cable length	Approximate 20 cm
Usage environment	-10 to 50°C, 80% RH or less (non-condensing)
External dimensions [W×D×H] (approximate)	46 × 66 × 27.4 mm (not including protruding parts)
Weight (approximate)	68 g



**External View**

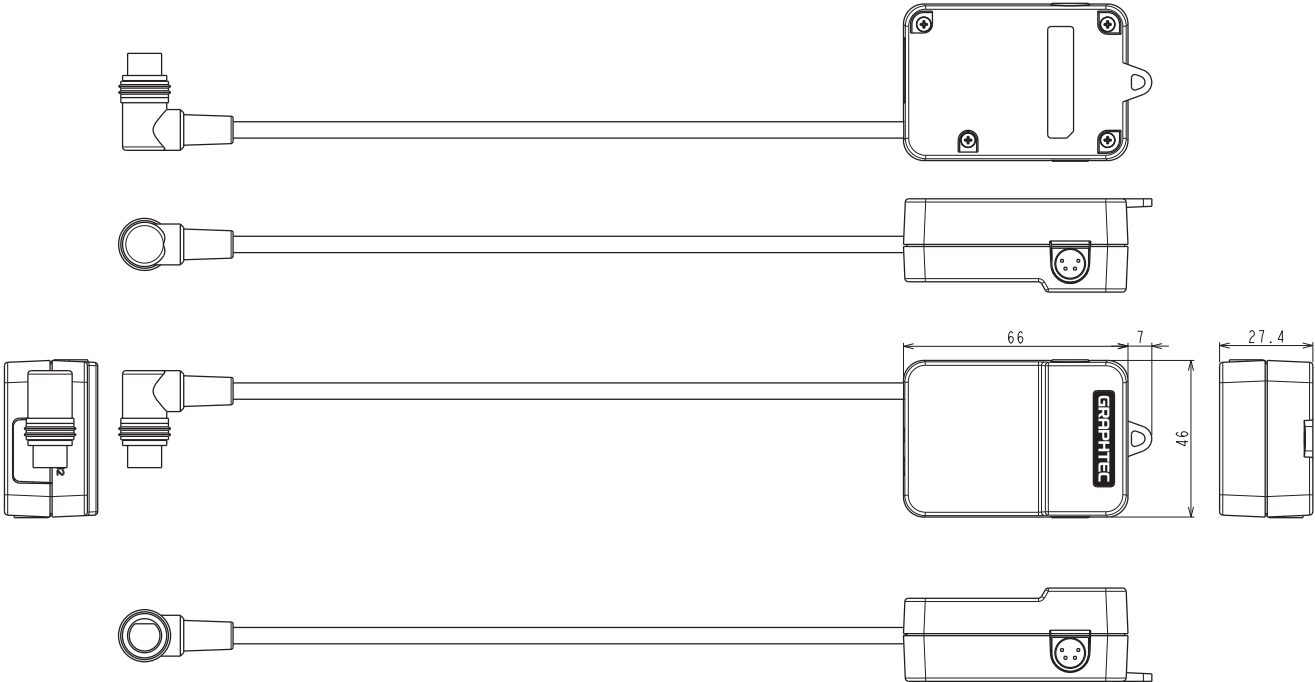

Unit: mm  
Dimensional accuracy: ±2 mm

## 4.3 Specifications of Application Software

### GL100-APS

Item	Contents
Supported OS	Windows 8.1/8/7/Vista (64/32bit)
Connection interface	USB, Wireless LAN
Function	Module control, real-time data recording, file conversion, data replay
Module Setting	Input, recording, alarm, and trigger settings
Recorded data	Real-time data (GBD binary, CSV) Memory data SD card data
Displayed information	Analog waveform, logic waveform, pulse waveform, digital value
Display mode	Y-T display, digital display, statistics and history displays, cursor display between the X and Y (replay only)
File convert	Between cursors, all data, culling function
Monitor function	Sending an E-mail to the address specified in the alarm monitoring, periodically sending E-mail
Report function	Daily report and monthly report files are automatically generated.

### GL100-Network\_Config

Item	Contents
Supported OS	Windows 8.1/8/7/Vista (64/32bit)
Connection interface	USB
Function	USB driver installation, GL100 firmware update, time adjustment, module name setting, wireless LAN settings, E-mail send and receive settings

### Smart Device Application Software

Item	Contents
Supported OS	iOS (7.0 or higher), Android (4.1 or higher)
Connection interface	Wireless LAN
Function	Digital display, waveform display (only when replaying), recording start/stop control, sampling interval change, E-mail sending module control function, customized function

# INDEX

## Sign

3-axis Acceleration / Temperature Sensor .....	2-11
4ch Thermistor Terminal .....	2-13
4ch Voltage / Temperature Terminal .....	2-8

## A

Accessories .....	2-3
Adapter for AC Current Sensor .....	2-16
Adapter for Branch Adapter .....	2-27
ALARM .....	3-18
Alarm Output Terminal .....	2-4, 2-7
AMP .....	3-15

## B

Battery cover .....	2-4
Before Setting Up .....	3-2

## C

Checking the Accessories .....	2-2
CO2 Sensor .....	2-24
Connector cover .....	2-4

## D

DATA .....	3-16
date adjustment .....	3-8

## E

External View .....	4-3
---------------------	-----

## H

Hook bracket .....	2-4
How to confirm the recorded data .....	3-26
How to connect AC adapter .....	3-6
How to connect to PC .....	3-6
How to install the batteries .....	3-5
How to Switch On the Power .....	3-3
How to Switch to Power OFF Mode .....	3-4

## I

I/F .....	3-18
Illumination / Ultraviolet Sensor .....	2-22

## L

LOGIC .....	3-15
-------------	------

## M

MAIL .....	3-21
Measurement Procedure .....	3-12
microSD .....	2-7
microSD slot .....	2-4
Module Connection Terminal .....	2-4
Module connection terminal .....	2-6
Module .....	2-3
Monitor .....	2-4
Mounting screw holes .....	2-4

## N

Nomenclature and Functions .....	2-4
----------------------------------	-----

## O

Operating Environment .....	1-3
Operation key .....	2-4
OTHER-1 .....	3-22
OTHER-2 .....	3-23

## P

Power-on .....	3-3
----------------	-----

## S

Safety Precautions .....	ii
Specifications of Application Software .....	4-20
Standard Accessories .....	2-2
Standard Specifications .....	4-2
Standard Specifications (Module) .....	4-4

## T

Temperature / Humidity Sensor .....	2-25
time adjustment .....	3-8
To Ensure Safe and Correct Use .....	i
TRIGGER .....	3-17

## U

USB I/F .....	2-7
USB I/F terminal .....	2-4

## V

Various Connections .....	2-6
---------------------------	-----

## W

Warming-up .....	1-4
------------------	-----



Specifications are subject to change without notice.

---

GL100 Series User's Manual

GL100-UM-151

July 11 2014 1st edition-01

**GRAPHTEC CORPORATION**

---

**GRAPHTEC**