

CHRONOS

HIGH-SPEED CAMERAS



USER MANUAL

CHRONOS 1.4 & CHRONOS 2.1-HD

Software Version 0.5.1

RE-PDEV-10007 Rev 1.0

Preface

Thank you for choosing a Chronos high-speed camera!

This camera was designed to be accessible to everyone, and we hope that you will experiment, explore and create.

Please share videos, pictures, publications and details about your user cases with our team at any time. We would love to see what you're creating, and perhaps share it with our audience on social media, monthly newsletter, or even our website if you would like!

This guide will help you operate, troubleshoot, and get the most out of your camera and its accessories. We also advise you to read the separate document, [Terms of Sale and Warranty](#) (see website). If you have any questions about either document, please contact info@krontech.ca.

Also, to receive important news about software updates, release of new products, major company announcements, or special discounts, please sign up for our monthly newsletter by:

- Visiting <https://www.krontech.ca/chronos-newsletter/>.

OR

- Scanning this QR code:

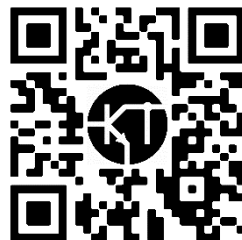

Support Contacts

DIRECT SUPPORT

If you have questions or concerns about hardware, software or special instruction for your Chronos camera and its accessories, please don't hesitate to contact us at: support@krontech.ca.

WEB SITE LINKS

FAQ <https://krontech.ca/faq>
Shipping Policy <https://krontech.ca/shipping-policy>
Warranty & Return <https://krontech.ca/warranty-return>

Chronos 1.4
Resources <https://krontech.ca/chronos-1-4-resources>

Chronos 2.1-HD
Resources <https://krontech.ca/chronos-2-1-resources>

USER FORUM

The User Forum is a great way to share questions with other Chronos users, as well as get support directly from Kron Technologies staff; use the search function on the forum to find answers to your questions.

User Forum: <https://forum.krontech.ca>

Table of Contents

Preface	2
Support Contacts	3
Unboxing	8
What's included	8
First Look.....	9
Setup.....	11
DISABLING THE SHIPPING MODE	11
LENS INSTALLATION	12
POWERING UP THE CAMERA	12
POWERING DOWN THE CAMERA	13
BATTERY CHARGING	13
Getting Ready	14
SETTING RESOLUTION & FRAME RATE	14
BLACK CALIBRATION	15
PERFORMING A BLACK CALIBRATION	15
WHITE BALANCE	16
WHITE BALANCE CALIBRATION	16
Recording.....	18
RING BUFFER CONCEPT	18
SIMULTANEOUS RECORDING OF REAL-TIME FOOTAGE	19
CHEAT SHEET TO YOUR FIRST RECORDING	20
SHUTTER BUTTON	21
EXTERNAL TRIGGERS	21
SIGNAL CONDITIONING	22
SYNCHRONIZING TO EXTERNAL SOURCES	22
TRIGGER MODES	22
TOGGLE TRIGGER	22
RECORD END TRIGGER	23
EXPOSURE TRIGGER	23
SHUTTER GATING	24
SHUTTER GATING TIMING REQUIREMENTS	25
Playback	26
Saving	27

Network Interface	29
STATIC IP ADDRESS CONFIGURATION	29
DYNAMIC IP ADDRESS CONFIGURATION VIA DHCP	29
ETHERNET OVER USB	29
SAVING TO NETWORK STORAGE	29
Web Control	31
ACCESSING THE CAMERA'S WEBPAGE	31
NAVIGATING THE CAMERA'S WEBPAGE: MAIN	32
NAVIGATING THE CAMERA'S WEBPAGE: PLAY & SAVE	33
NAVIGATING THE CAMERA'S WEBPAGE: SETTINGS	34
NAVIGATING THE CAMERA'S WEBPAGE: I/O CONFIG - SIMPLE	35
NAVIGATING THE CAMERA'S WEBPAGE: I/O CONFIG - ADVANCED	36
Annex A – Hardware	38
CAMERA'S BACK	38
POWER BUTTON	38
SHUTTER BUTTON	38
RECORD INDICATORS (2)	38
POWER STATUS INDICATOR	39
JOG WHEEL	39
SD CARD SLOT	39
CAMERA'S SIDE	40
HDMI	40
AUDIO IO	40
USB/ESATA	40
BNC	41
MINI USB OTG	41
ETHERNET	41
AUX IO	41
POWER INPUT	41
CAMERA'S BOTTOM	42
SYSTEM SD SLOT & CARD	42
MOUNT POINT	42
BACK-FOCUS LOCK SCREW	42
BATTERY COMPARTMENT	42
Annex B - Lenses	43

LENS MOUNT & ADAPTER	43
LENS SELECTION	44
BACK-FOCUS ADJUSTMENT	44
PRIME LENSES (NON-ZOOM)	44
ZOOM LENSES (PARFOCAL LENSES ONLY)	45
Annex C – IR Filter	46
IR FILTER	46
REMOVING THE IR FILTER	46
Annex D – Trigger Inputs/Outputs	47
TRIGGER INPUTS/OUTPUTS	47
TRIGGER IO 1 AND 2	47
TRIGGER IN 3	48
Annex E – Troubleshooting.....	49
Annex F – Specifications.....	51
CHRONOS 1.4.....	51
CHRONOS 2.1-HD.....	54
Annex G – Maintenance & Care.....	57
OPTICS	57
CAMERA BODY	57
SCREEN	57
Annex H – Record Rates & Times.....	58
RECORD PRESET VS RECORD DURATION	58
CHRONOS 1.4.....	58
CHRONOS 2.1-HD	59
RECORD FPS VS RECORD DURATION	60
CHRONOS 1.4.....	60
RECORD RESOLUTION VS RECORD DURATION	61
CHRONOS 1.4.....	61
Annex I – Storage & Shipping	62
Annex J – Mechanical Drawing	63
CHRONOS 1.4 / CHRONOS 2.1-HD	63
Annex K – Spectral Response.....	64
CHRONOS 1.4.....	64
CHRONOS 2.1-HD	65
Annex L – Software Functions.....	66

MAIN WINDOW	66
RECORD SETTINGS	68
RECORD MODE – NORMAL	71
RECORD MODE - SEGMENTED	72
RECORD MODE – GATED BURST	74
RECORD MODE – LIVE SLOW MOTION	76
TRIGGER / IO SETTINGS	78
TRIGGER DELAY	80
BLACK CALIBRATION	82
WHITE BALANCE	83
CUSTOM COLOR MATRIX WINDOW	85
PLAY	86
SAVE SETTINGS	88
COMPARISON OF SAVE FORMATS	90
UTILITIES SCREEN - MAIN	91
STORAGE TAB	94
SOFTWARE UPDATES	96
NETWORK TAB	100
ABOUT TAB	101
FACTORY TAB	102

Unboxing



IMPORTANT: The camera ships with a dust cap and installed CS-C Adapter Ring (above). Make sure you don't accidentally remove the CS-C Adapter Ring when removing the cap.

Unpack the camera and accessories, and check that all ordered accessories are included. If anything is missing or damaged, please notify us immediately at support@krontech.ca.

What's included

The following items are included as standard with all cameras:

- Chronos Camera
- EN-EL4a Battery
- 19V 40W AC Adapter
- AC Power Cord (plug depends on region)
- CS-C Adapter Ring (installed on camera)
- C Mount Dust Cap (installed on camera)
- 2mm Allen Wrench
- User Manual

If you have ordered lenses and other accessories, please check your package contents against the invoice to make sure that your order is complete.

First Look

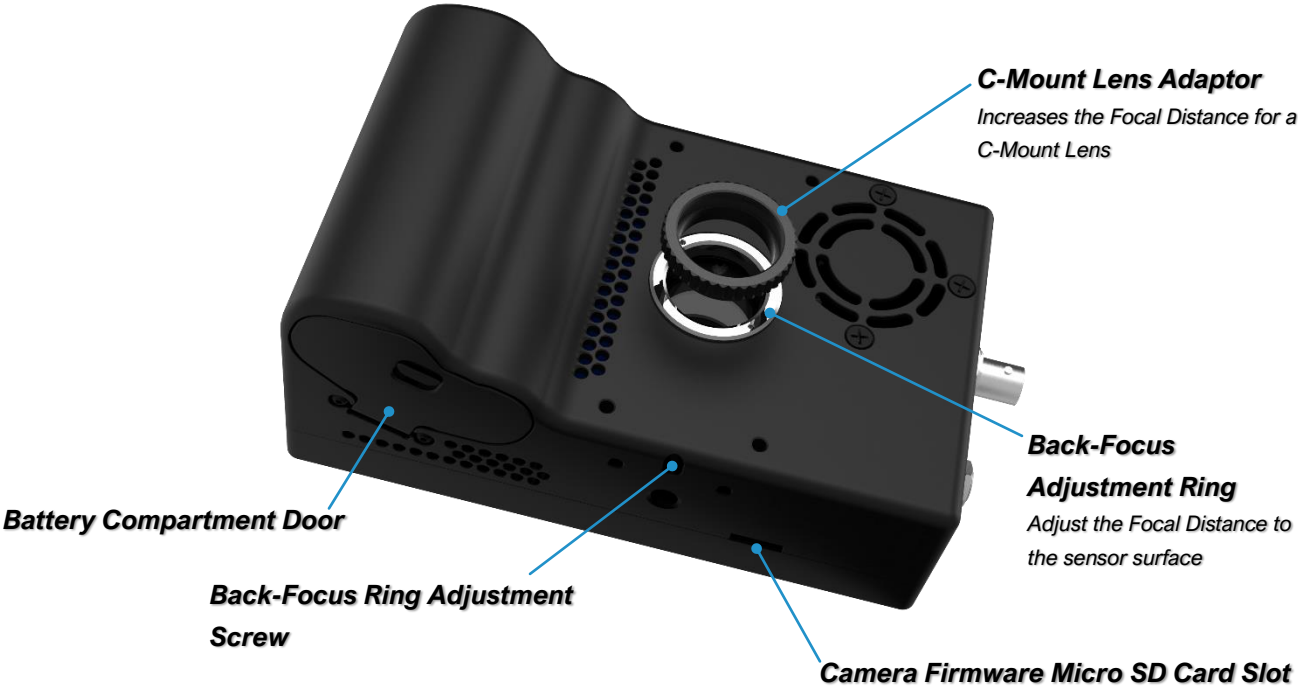
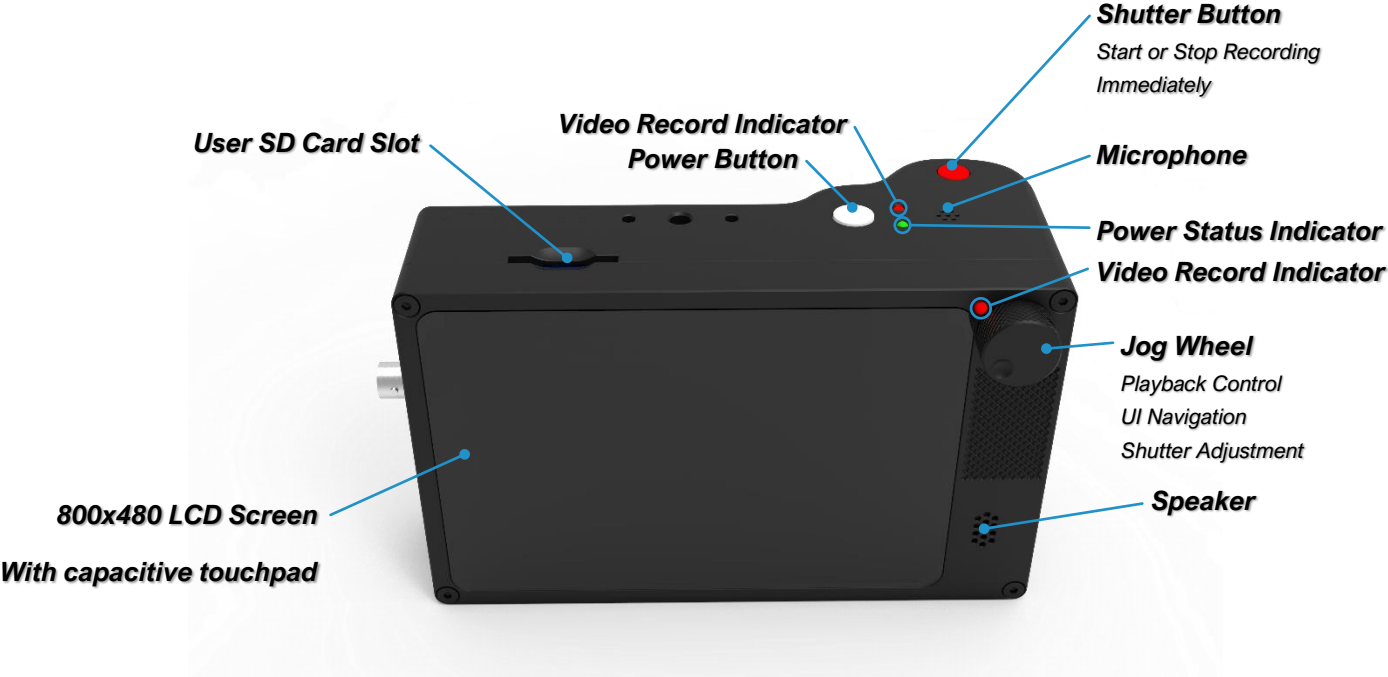

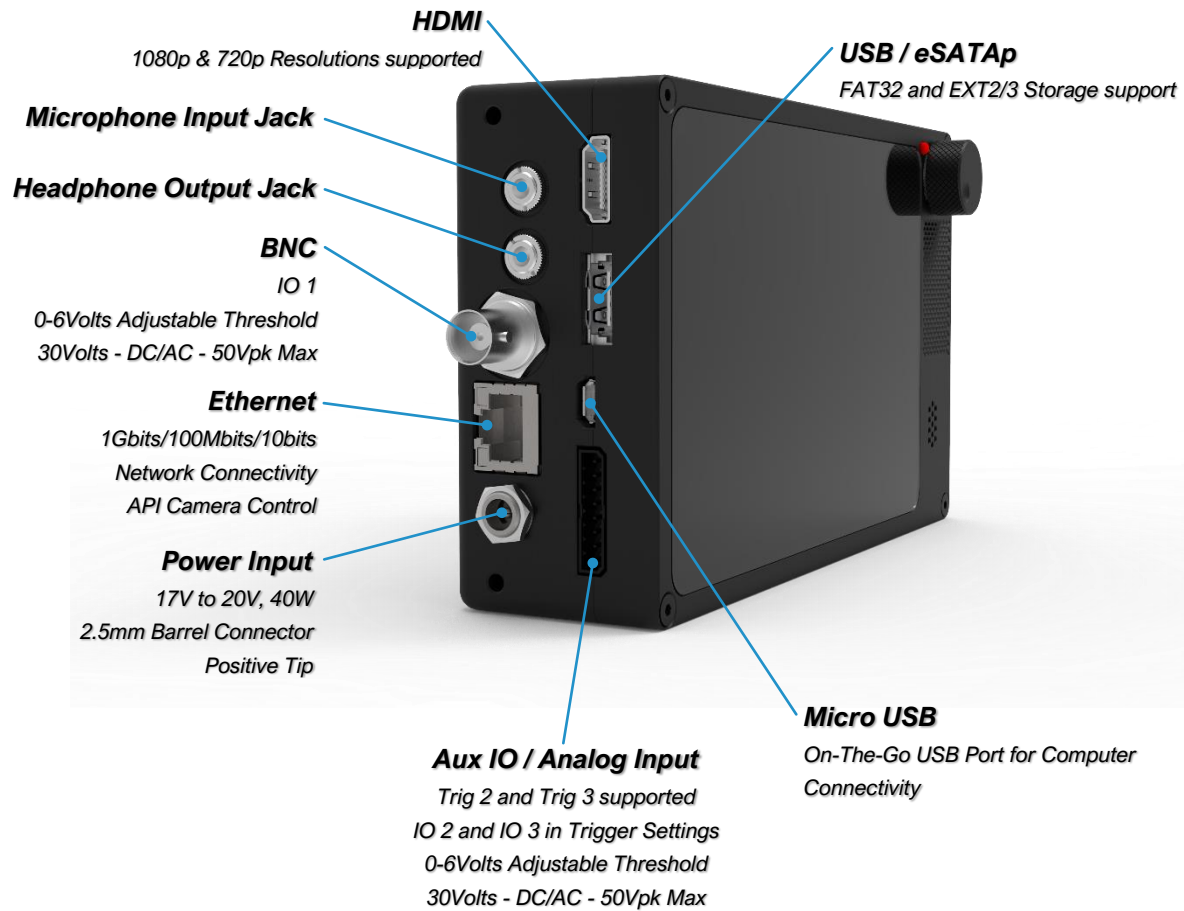

Setup

DISABLING THE SHIPPING MODE

After the camera is unpacked and ready to be fired up, the first thing to be done will be to disable the shipping mode. The shipping mode disables the usage of the power on button, so the camera doesn't accidentally get activated during transit which would lead to the battery being drained.

In order to disable that safety feature, connect your AC Power Adapter to a power outlet and connect the barrel connector to the camera.

For the camera to disable the shipping mode, it needs to recognize that the camera is connected to the main power source that recharges the battery. If the AC power adapter is correctly installed and you press the power button to power up the camera, the camera will boot up normally.

Once the camera has booted normally, shipping mode will automatically be disabled, so that subsequent power-ups of the camera do not require an external power source.

It is recommended that the AC power supply remains connected until the battery is fully charged.

IMPORTANT: If Shipping Mode was enabled and needs to be disabled prior to a power cycle, the checkbox in the Util -> Factory menu can be de-selected.

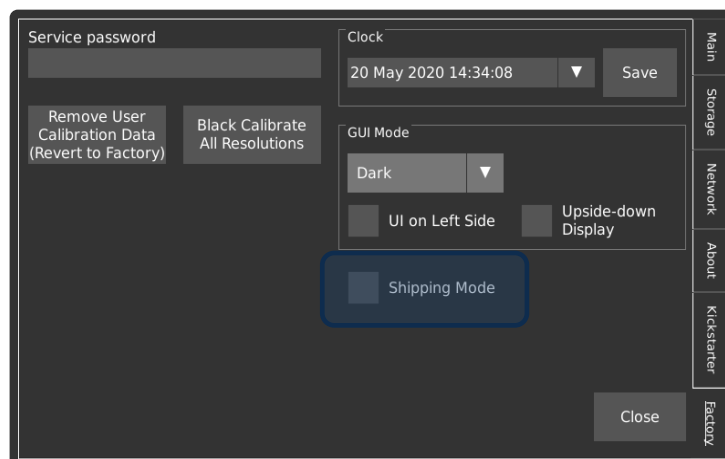

LENS INSTALLATION

Remove the body cap and install the lens by screwing it onto the mount.

IMPORTANT: For the COMPUTAR 12.5-75mm Zoom Lens, the CS-C Adapter needs to be left on. If you're using another lens, refer to the table below for types and support materials to determine whether the CS-C Adapter is needed.

Lens Model	Lens Mount	Adapter Required
COMPUTAR 12.5-75mm f/1.2 Zoom	C	CS - C
COMPUTAR 12mm f/1.4 Prime	C	CS - C
6-60mm f/1.7 Zoom*	CS	None
2.8-12mm f/1.4 Zoom*	CS	None
COMPUTAR 8mm f/1.4 Prime	C	CS - C
FUJIAN 35mm f/1.7	C	CS - C
Microscope Lens	C	CS - C
SIGMA 24-70mm f/2.8 Zoom	F	F - C

IMPORTANT: * Zoom lenses have the side effect of not covering the entire sensor, which will create a black ring around the periphery of the image. This phenomenon is also called "VIGNETTING" thus, the user ought to be aware of that fact. Please also note that the only lenses that will not cause "VIGNETTING" with the Chronos 2.1-HD are the FUJIAN and SIGMA models in the list above.

POWERING UP THE CAMERA

To turn on the camera, simply do a press and release of the power-on button. Give about a minute for the camera to boot and to initialize itself. When the process is complete you will be greeted by the screen below.

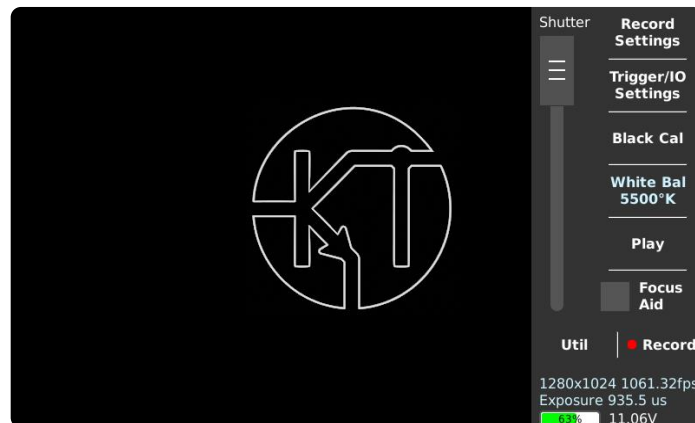

POWERING DOWN THE CAMERA

To turn off the camera, press the power on button for at least 0.5 sec to less than 4 sec**.

Like a computer, the camera needs to shut down properly to avoid problems with the operating system. Don't force a hard power down unless the camera is unresponsive and will not power down normally.

IMPORTANT: ** Do not continue to hold the button; holding it for more than 4 seconds will force a hard power-down. A hard power-down will shut down the camera without the OS knowing about it and thus possibly creating instability in the system.

BATTERY CHARGING

Before you run the camera on battery power, charge the new battery up to at least 80% (LED flashes green/orange, or is solid green). This should take less than 2 hours.

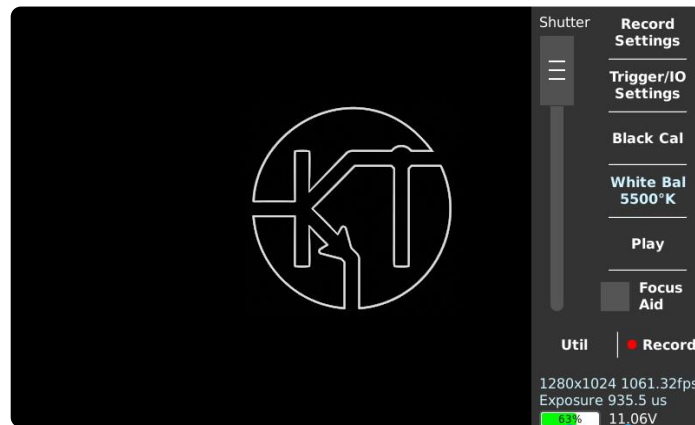

Battery Capacity and Voltage Level

Getting Ready

SETTING RESOLUTION & FRAME RATE

The Chronos cameras allows you to trade image resolution for frame rate. In many applications, temporal resolution (frame rate) is far more important than spatial resolution (image resolution).

The image resolution can be adjusted in two ways. Common pre-set resolutions are available from the drop-down menu on the bottom left of the Record Settings page. There are also direct resolution controls at top right. Resolution can be adjusted in increments of 2 pixels vertically, and 16 pixels horizontally on the Chronos 1.4, or 32 pixels on the Chronos 2.1-HD.

Record Settings

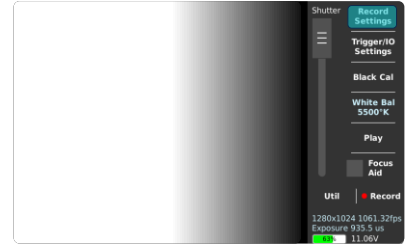

Full Frame
Chronos 1.4: 1280x1024
Chronos 2.1-HD: 1920x1080

Custom Resolution Entry Field

Region of Interests

List of presets

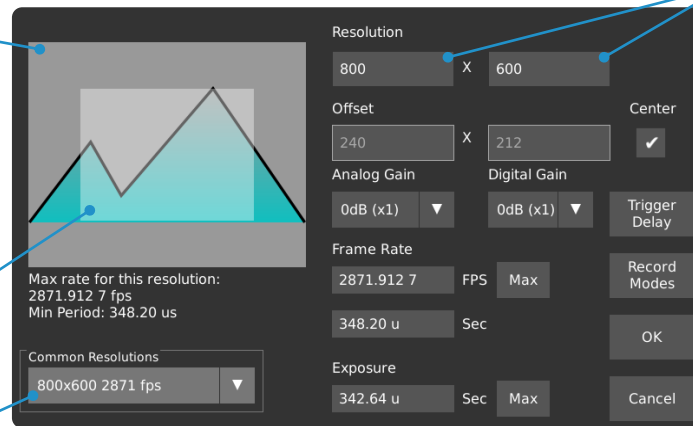

Tap on the text box to enter a resolution using the keyboard or use the up/down buttons to adjust in minimum increments. As the resolution is changed, the Region of Interest (ROI) display shows the resulting image size within the full resolution of the image sensor. The maximum frame rate and minimum frame periods are displayed under the ROI display.

Once the desired resolution is set, the frame rate can be adjusted from 60fps to the maximum shown under the ROI display. The Max buttons will set the frame rate and exposure to their respective maximum values for the current resolution.

IMPORTANT: When using resolutions other than those shown in the Common Resolutions drop-down box, it is important to do a Black Calibration, as only common resolutions are calibrated at the factory. When an un-calibrated resolution is selected, a basic Black Calibration is automatically taken with the shutter speed at minimum. This allows a reasonable image display for immediate use, but a full Black Calibration is recommended for best quality.

BLACK CALIBRATION

Black Calibration

For best image quality, the camera automatically subtracts a black reference image from all captured frames, correcting for pixel variations that occur on the image sensor. This reference is updated by the Black Calibration.

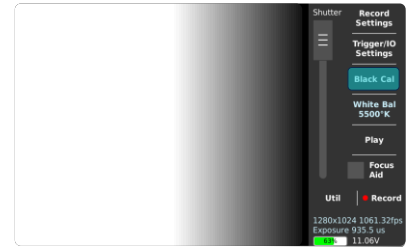

This is unique for each resolution, gain setting, and shutter speed, i.e. a Black Calibration performed at 1280x1024 with 0dB gain does not apply to 1280x1024 with 6dB gain. Black Calibration issues manifest as lines across the video, or as a negative image of an object that was in frame.

PERFORMING A BLACK CALIBRATION

First, let the camera reach normal operating temperature by letting it run for 15-25 minutes. Fully close the iris or put the lens cap on. Once all light is completely blocked from the image sensor, tap the Black Cal button on the main screen.

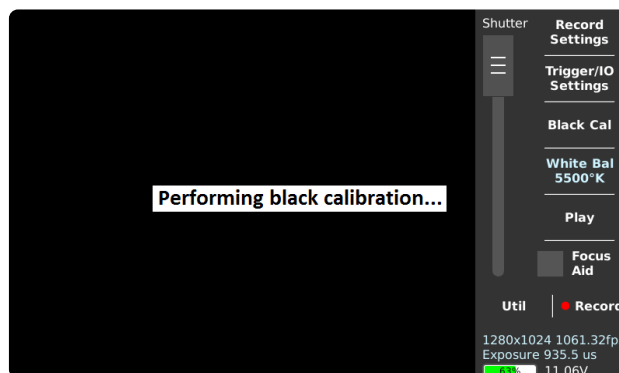

The Record LED will flash as the camera records the black reference frames. This will discard any unsaved video. Once the Performing Black Calibration.. message goes away, you can safely open the iris or remove the lens cap, as the black reference frames are fully captured.

Depending on resolution, a Black Calibration can take up to 15 seconds. It is persistent across restarts and will be remembered the next time you select the same resolution.

IMPORTANT: Perform a Black Calibration after changing the resolution, frame rate or shutter speed.

WHITE BALANCE

White Balance is an adjustment in electronic and film imaging that corrects for the colour balance of the lighting - so that white objects appear white, rather than coloured (for example) yellow when lit by tungsten filament lights, or excessively blue under sunlight.

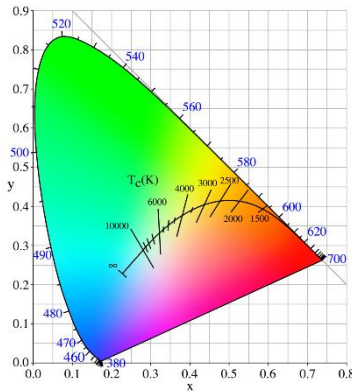
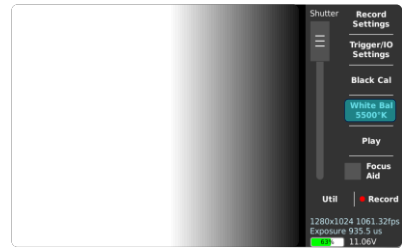

Most digital cameras have automatic compensation for white balance, and the more advanced allow some manual adjustment - either to fixed settings or balancing on a particular image (e.g. a grey card). The white balance is adjusted by applying different weightings to the red, green and blue (RGB) components of the image coming from the sensor - based on the colour temperature.

WHITE BALANCE CALIBRATION

1st Method:

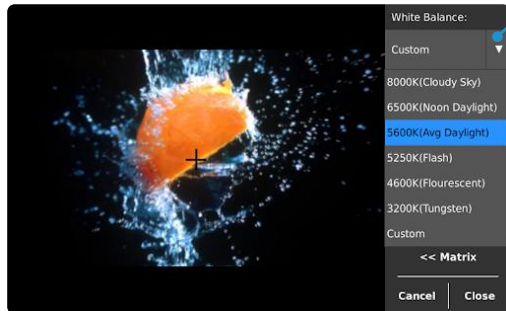

Tap here to select a preset

The easiest and fastest way to adjust the white balance is by evaluating the environmental light around the subject. To put in front of the camera a white piece of paper and to select from the drop-down menu "White Balance" the presets that matches the type of light used and to make the white of the paper come out as white as possible without any blue or orange tint.

2nd Method:

Make sure to select "Custom" in the presets

The second way to adjust the color temperature to match the scene is to put a properly lit white piece of paper in front of the camera. Then, select from the presets list "Custom" and then tap the "Set Custom" button for the camera to estimate the right amount of correction to obtain the best neutral white possible.

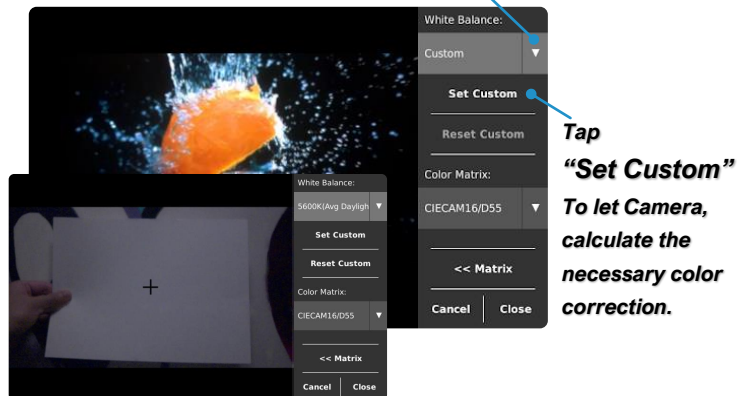

Tap "Set Custom" To let Camera, calculate the necessary color correction.

3rd Method:

Make sure to select "Custom" in the presets

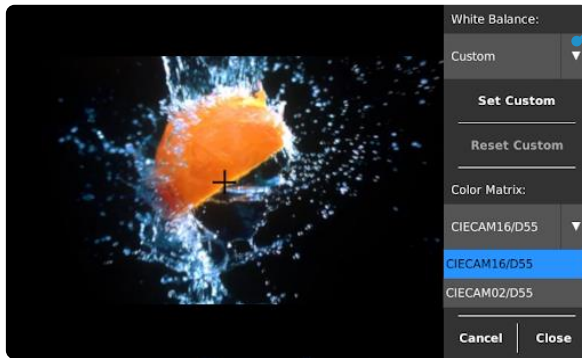

Another way to adjust the White Balance is while in custom mode, a standard "illuminant" matrix can be chosen from the presets list.

4th Method:

If one would want to have more flexibility when it comes to adjust the White Balance, then one would be using the "Custom Color Matrix" to fine-tune each element of the conversion matrix. Kron Technologies would recommend using this method only when the understanding of White Balancing has been mastered by the user.

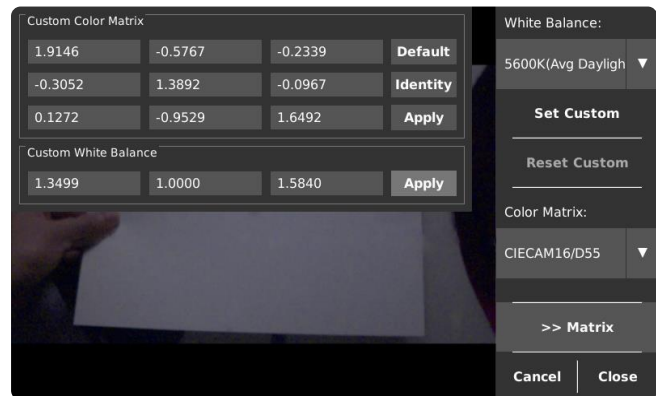

Recording

RING BUFFER CONCEPT

Before starting to record, it is important to understand the concept of how the images are stored in the camera. Considering that the camera needs to capture an immense amount of data in a very short time, the quantity of very fast memory is limited, hence it is paramount to manage that memory properly to mitigate the loss of frames after the camera has been set to record.

In order to capture all these images, the Chronos cameras will record to what is called a **Ring Buffer** in the internal high-speed RAM. The ring buffer is a data structure that holds frames of recorded video. Once it's full, the oldest frames are overwritten as new frames are captured. This allows the camera to record for unlimited periods, but only the most recent frames are kept.

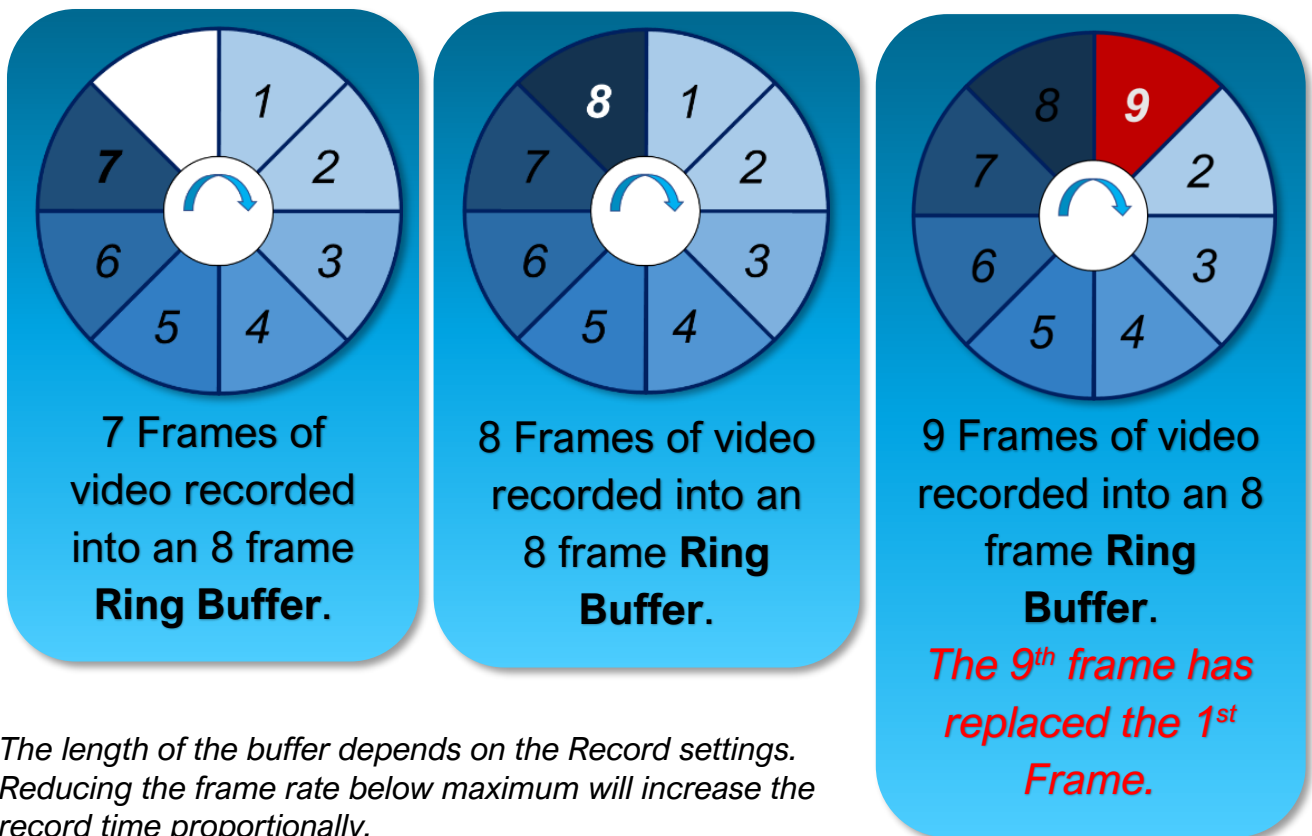

The length of the buffer depends on the Record settings. Reducing the frame rate below maximum will increase the record time proportionally.

For example, if the maximum frame rate for your resolution is 3000fps, setting the rate to 1000fps will result in 3x the record time available at maximum frame rate.

Another way to record for longer is to record a lower resolution video.

If 4 frames of 800×600 video fit into a Ring Buffer, then 8 frames of 800×300 video will fit into the same Ring Buffer.

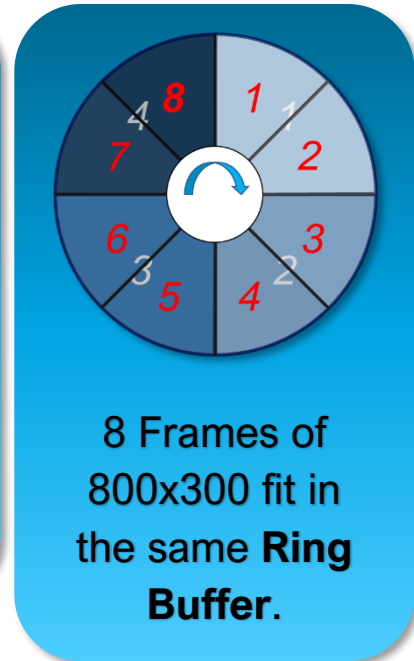
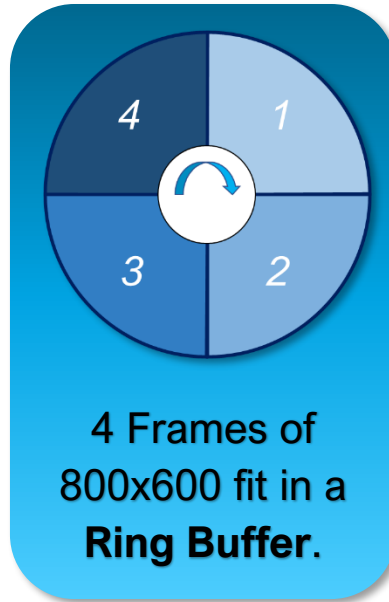

SIMULTANEOUS RECORDING OF REAL-TIME FOOTAGE

While the camera excels at recording high-speed footage, it can also be used to simultaneously record the 60 FPS version of an event. To enable this feature, navigate to **Util**, then select the **Live Record @ 60 FPS** checkbox.

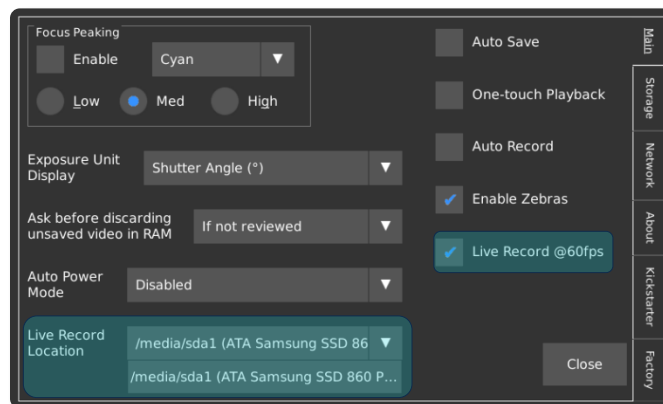

Once enabled, the camera will save a MPEG-4 video with audio to the specified location while the record light is on. The camera will automatically switch from the built-in microphone to the Microphone Input Jack if it detects a line input.

IMPORTANT: If this mode is enabled, the camera may take a few seconds longer to allow interaction with the back-of-camera controls after the recording is stopped. Do not disconnect the external storage device until it can be **Safely Removed** via the **Storage** menu in the **Util** screen.

CHEAT SHEET TO YOUR FIRST RECORDING

Perform a Black Cal with the desired Resolution & Frame Rate to ensure best image quality

For Maximum sharpness on the COMPUTAR 12.5-75mm lens, use an iris of F/2 or above

In normal Record mode, the camera records continuously until stopped, either by the Shutter button, the Record/Stop button, or an external trigger.

Please see the next section for more information about the different triggering modes.

Set the desired resolution.

On the first boot:

 - Defaults to 1280x1024

 - Defaults to 1920x1080

Turning the resolution down will get you a higher frame rate. However, Horizontal resolution below 320 pixels does not increase speed.

Perform the white card test on your scene and select the proper white balance illuminant to achieve a neutral white. (For Color Sensor Only)

To **Start** or to **Stop** recording, tap Record on the LCD, or click the red button on top of the camera.

To enjoy immediately the captured footage, you can get in the playback menu by tapping on the "Play" button. For more details on the playback mode, see the section dedicated to it.

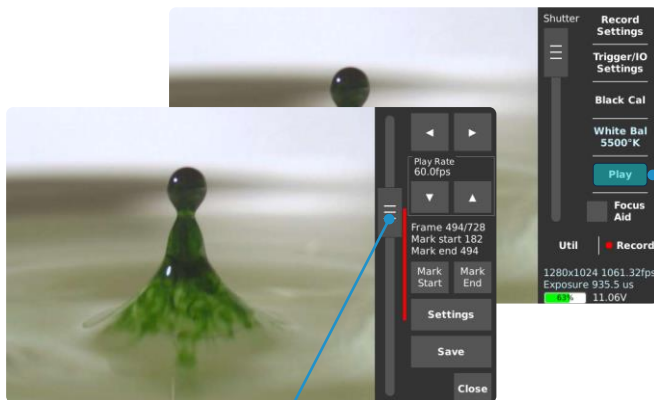
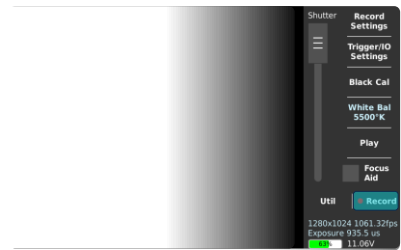
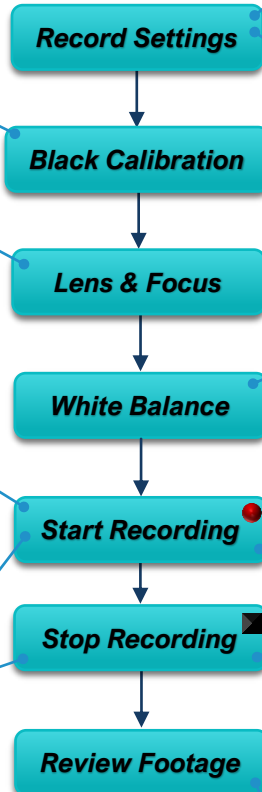

Use the slider to go through the captured footage.

Triggering

Trigger/IO Settings

SHUTTER BUTTON



The red shutter button on top of the camera will toggle between enable or disable the Recording.

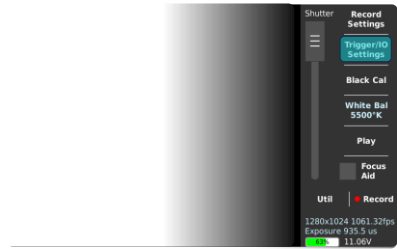

IMPORTANT: Trigger delays do not apply to the shutter button; pressing the button while recording will start/stop the recording immediately, regardless of any pre-set trigger delay.

EXTERNAL TRIGGERS

Triggers can be configured to either stop a recording (after a trigger delay is recorded), start a recording (via BNC cable), or control the camera shutter.

The Chronos 1.4 and Chronos 2.1-HD have 3 available external trigger inputs:

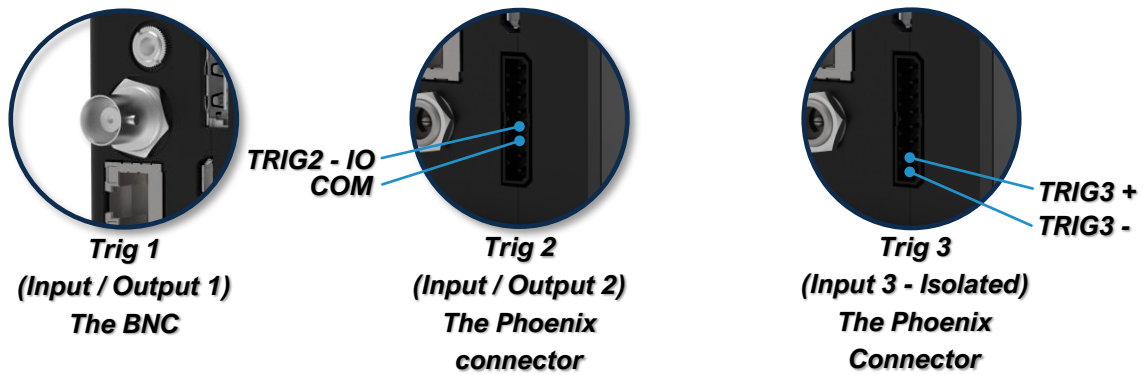

Triggers are configured in the “Trigger/IO Settings” menu:

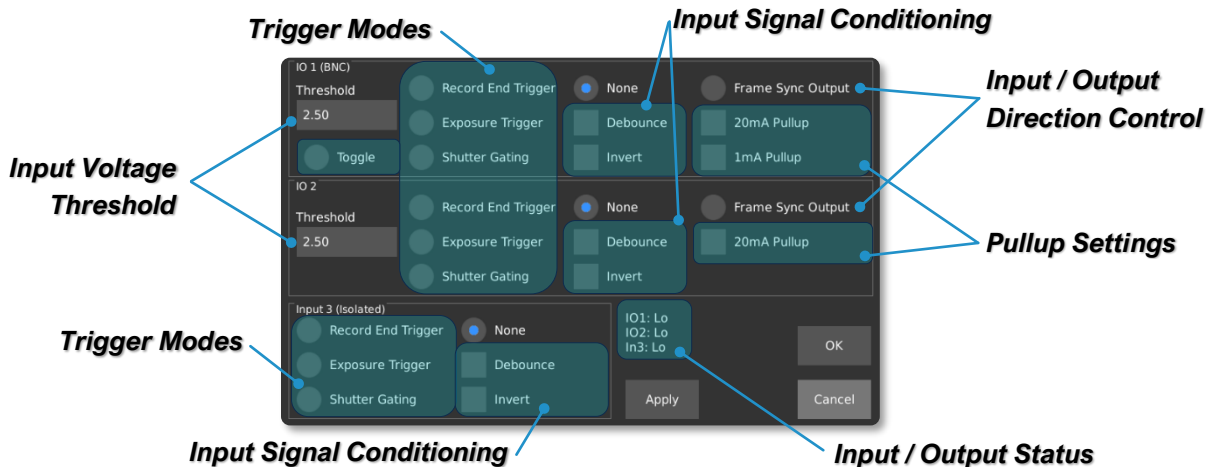

TRIG1 and TRIG2 can also change direction and output a frame sync signal (a signal synchronized with the exposure of the sensor).

To trigger the camera with a BNC trigger switch from our store, go to the IO settings screen and adjust the following for IO 1 (BNC):



- Enable a pullup
- Set Signal Conditioning for **Debounce**
- Set Trigger Type to **Record End Trigger**
- Plug the Trigger cable into the BNC Connector
- Make sure IO1 Status shows as **Hi** when the button is **not pressed**
- Press on the trigger button to verify that the status goes from **Hi** to **Lo**
- **You are ready to go**

IMPORTANT: For more information on triggering, see our tutorials here:

<https://www.krontech.ca/chronos-1-4-resources/>

<https://www.krontech.ca/chronos-2-1-resources/>

SIGNAL CONDITIONING

No Conditioning Applied

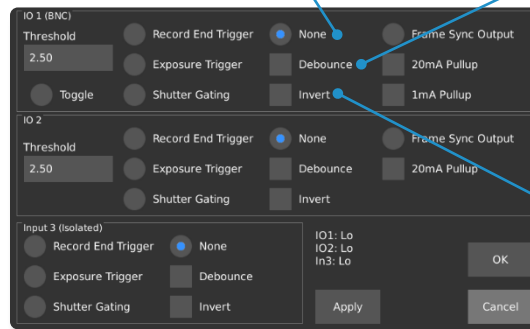

Enable when using a Physical Switch like Push-button, Relays, etc. The Input will be sampled at 10ms to avoid spurious triggers.

Changes the Edge Detection
Checked: Falling Edge 
Unchecked: Rising Edge 

SYNCHRONIZING TO EXTERNAL SOURCES

TRIGGER MODES

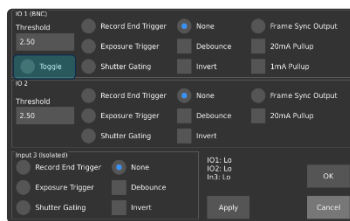

TOGGLE TRIGGER

When selected, the trigger is setup to start a recording on one push of the BNC trigger switch, while stopping a recording on the subsequent push in **Normal** recording mode.

RECORD END TRIGGER

When selected, the trigger is setup to terminate the recording. Depending on the state of the **Invert** flag, either pushing or releasing the button will stop the recording.

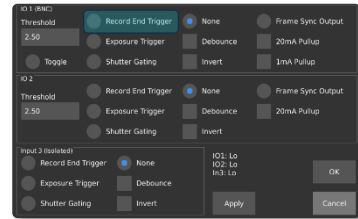

EXPOSURE TRIGGER

In this mode, an external trigger connected to TRIG1, TRIG2 or TRIG3 controls the start of exposure. The exposure duration, however, is controlled by the camera.

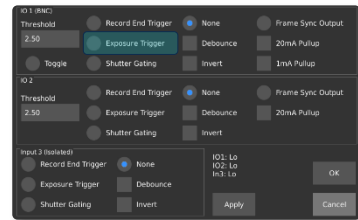

Steps to follow to configure the camera properly to use the Exposure trigger:

1. In **Record Settings**, select the desired resolution and maximum frame. The exposure Time is limited to $1/[\text{Frame Rate}]$; if longer exposures are desired, you must reduce the frame rate.

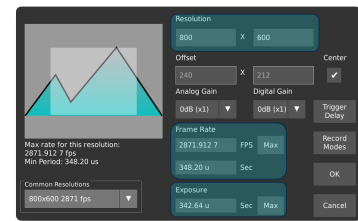

IMPORTANT: If you select a frame rate lower than the maximum, the sensor may be set to a low frame rate mode. This will limit the maximum achievable frame rate.

2. In **Triggers/IO Settings**, select **Exposure Trigger** for the desired input. With **Invert** unchecked, exposure will start on the rising edge of the input.

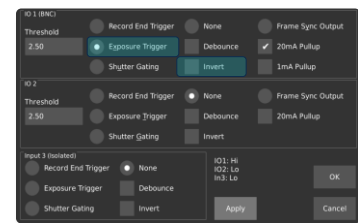

IMPORTANT: The frequency of the external triggering signal **MUST NOT** be higher than the frame rate specified in **Record Settings**. Frames will be dropped if this requirement is not met.

Note: In this mode, **Black Calibration** can only be performed when a stable and repetitive trigger is received by the camera. If a stable trigger source isn't available, set the mode to **None** in Trigger/IO Settings, perform a **Black Calibration**, and then set the mode back to **Triggered Exposure**.

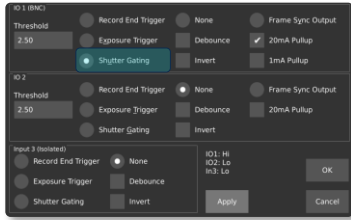

SHUTTER GATING

Shutter gating is about the shutter being directly controlled by TRIG1, TRIG2 or TRIG3. Exposure occurs for as long as the signal is active.

Steps to follow to configure the camera properly to use the **Shutter Gating**:

1. In **Record Settings**, select the desired resolution and maximum frame. The exposure Time is limited to $1/\text{Frame Rate}$; if longer exposures are desired, you must reduce the frame rate.

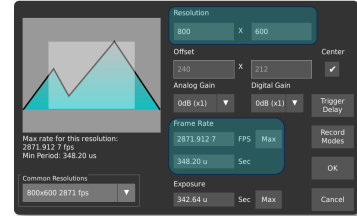

IMPORTANT: If you select a frame rate lower than the maximum, the sensor may be set to a low frame rate mode. This will limit the maximum achievable frame rate.

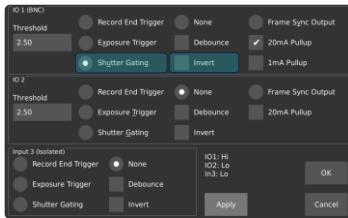

2. In **Triggers/IO Settings**, select **Shutter Gating** for the desired input. With **Invert unchecked**, exposure will start on the rising edge of the input.

Note: In this mode, **Black Calibration** can only be performed when a stable and repetitive trigger is received by the camera. If a stable trigger source isn't available, set the mode to **None** in Trigger/IO Settings, perform a **Black Calibration**, and then set the mode back to **Shutter Gating**.

SHUTTER GATING TIMING REQUIREMENTS

Shutter gating fundamentally places some limitations on the input signal, listed below are the conditions that need to be maintained for perfect integrity of the capture:

1. A minimum exposure of 1us must be maintained; undefined operation may occur with a pulse width below 1us.
2. To allow time for sensor read-out, Exposure end must occur at least one frame period (1 / frame rate) after the previous exposure. An example is shown below.
3. Sensor read-out time can be assumed to be the shortest frame period for the configured resolution and can be determined for your current resolution in the **Record Settings** window, under ROI display.

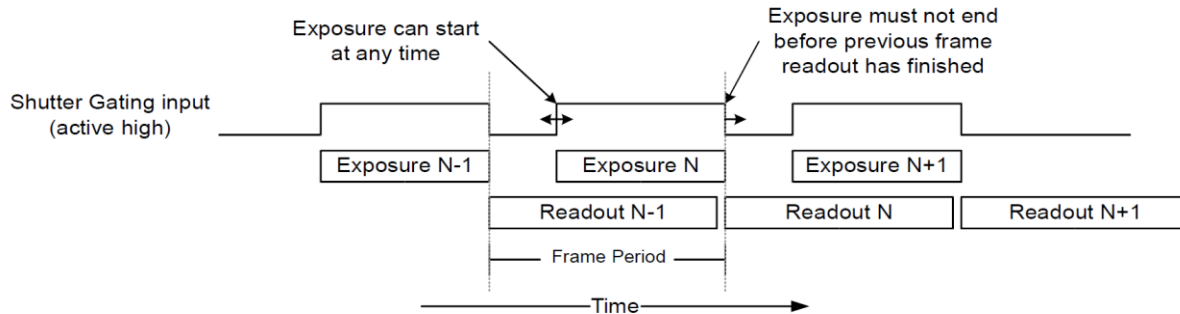

Playback

The **Playback** and **Save** are accessed through the play button on the main screen



When held down, the Left/Right buttons will play video forward or backward, at the frame rate specified in the Play Rate box.



Use the Forward/Backward play button, Slider or Jog Wheel to review the video.

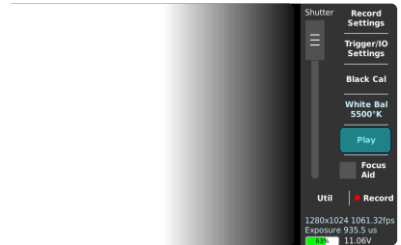

The **Playback** screen only plays back the most recently recorded video segment(s) stored in RAM.

Precise and quick playback control is available with the Jog Wheel. Turning the wheel moves playback by one frame per detent (rotational click), or 24 frames per turn. Pushing in the wheel while turning it moves playback by 40 frames per detent, or 960 frames per turn.

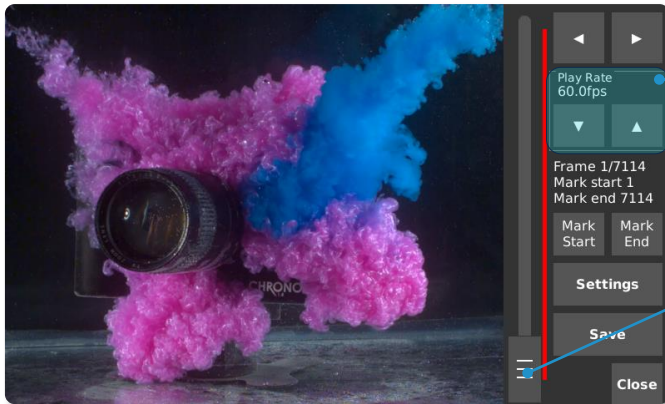

The Up/Down buttons will adjust the playback rate, from 10 up to 1920fps. This frame rate is for on-camera playback only; it does not affect the frame rate of the saved video.

Quick navigation is achieved with the Vertical Slider; the top of the slider is the most forward in time

NOTE: If *One-touch Playback* was enabled on the *Util* screen, you will see a Play button just to the left of the Close button. This will activate *One-touch Playback* mode where, once the button is tapped on the Play screen, the playback will loop between the marked start and end points.

Saving

Video can be saved in compressed H.264, RAW, CinemaDNG and TIFF formats, to removable storage such as SD cards, USB drives, and external hard drives.

Plug an SD card, USB drive or eSATA drive into the camera. The device must contain a partition formatted as FAT32, EXT2 or EXT3. For fastest saving, an eSATA 2.5" SSD or HDD is recommended.

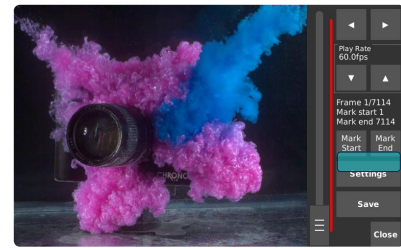

SD Card

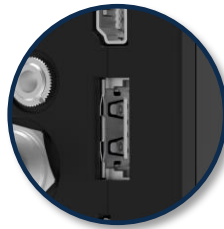

USB



eSATA

After connecting a storage device, open the **Save** Settings menu and select it as the save location.

From the Play screen, use the navigation controls and **Mark Start/Mark End** buttons to select the region of video you want to save. The save region is marked by a colored bar. In the desired save region. Please refer to Annex L – Save Settings for more details.

File Format Choice

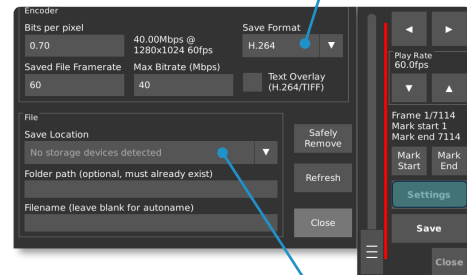

Media Storage

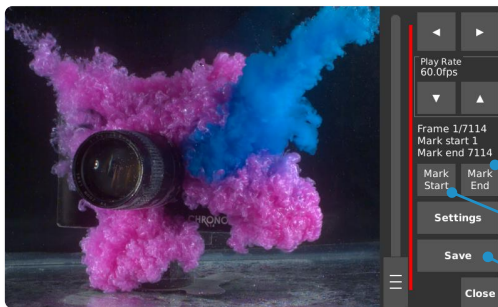

Use Mark Stop at the top

Use Mark Start at the bottom

When the marks are set, press Save, and wait for saving to complete

Repeat to save another range of video. Each saved region will be highlighted with a different color.

NOTE: Saving the entire buffer can take a long time, especially at high frame rates.

If the video is one that you won't be able to re-create, remove the storage device and plug it into your computer to check that the video has saved properly without dropped frames. This is especially important when using a new brand of SD card for the first time. (To remove the SD card, press down until a click occurs. It will pop out.)

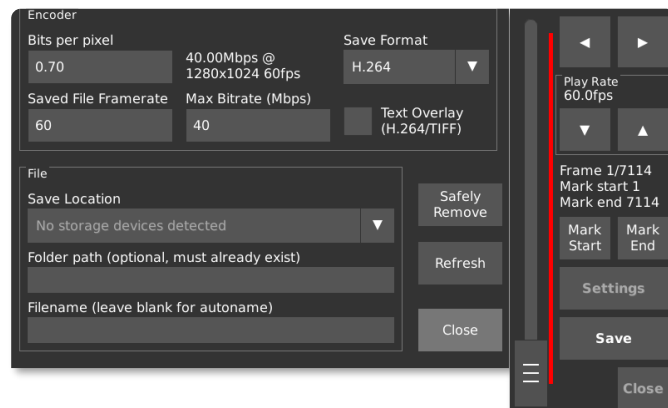

IMPORTANT: Always attempt to **Safely Remove** the storage device prior to disconnecting it from the camera.

Network Interface

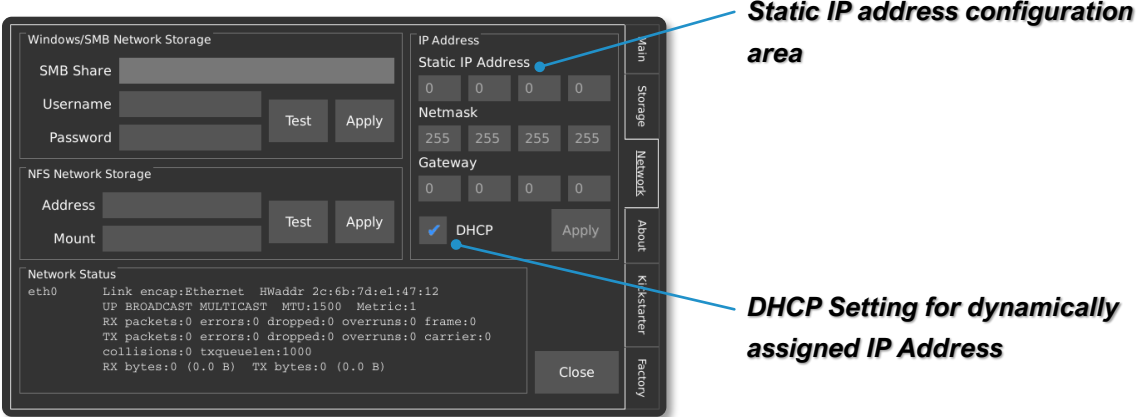

STATIC IP ADDRESS CONFIGURATION

The camera can be configured with a static IP address. To enter a static IP address, enter the **Util** menu and then navigate the **Network** tab. A box in the upper-right corner of the display offers fields for the IP, Netmask, and Gateway.

DYNAMIC IP ADDRESS CONFIGURATION VIA DHCP

The camera can automatically acquire an IP address via DHCP. To enable DHCP, ensure that the DHCP checkbox is enabled. The acquired IP address will be shown in the **Network Status** area.

ETHERNET OVER USB

The camera supports a virtual ethernet interface over the USB mini or USB micro connector. In Windows, this is referred to as a Remote Network Driver Interface Specification (RNDIS). If the camera is connected to the host computer using this method, the IP address will be a fixed value of **192.168.12.1**.

SAVING TO NETWORK STORAGE

The camera supports the ability to save footage directly to a computer over the network via **SMB v1.0** and **NFS** network protocols. Credentials to an SMB or NFS share can be entered on by navigating to the **Util** menu, and then selecting the **Network** tab.

In order to use the Network Storage functionality, the SMB v1.0 or NFS share must first be configured on the Host PC. Kron Technologies provides detailed step-by-step instructions on how to configure a Host PC's network share on the Chronos 1.4 and Chronos 2.1-HD resource pages at <https://www.krontech.ca>.

NOTE: When testing a Network Storage connection on the **Network** tab in the **Util** screen, tap **Apply** prior to using the **Test** button to test the configuration.

Web Control

ACCESSING THE CAMERA'S WEBPAGE

The Chronos can be controlled remotely via a webpage that is served by the camera itself. There are two methods to connect to the camera:

1. Establish a connection to a network via the ethernet port. Then navigate to the **Network** tab in the **Util** screen and find the IP address of the camera. The camera can either use DHCP to obtain an IP address dynamically or be configured with a static IP address.
2. Connect the camera directly to a computer via the USB mini or USB micro connector. When connected directly to a computer in this fashion, the camera will simulate an ethernet connection using the USB RNDIS Gadget Driver on Windows and will have the IP address **192.168.12.1**.

To access the webpage, enter the **IP address** from either method 1 or 2 above into the URL entry area of a browser. Kron Technologies recommends Chrome or Firefox as the preferred browser for using the web control page.

*IP Address from camera
entered into the web browser
of PC on the same network*

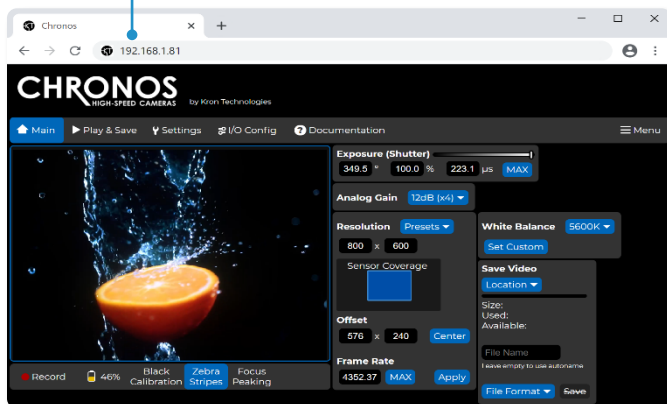
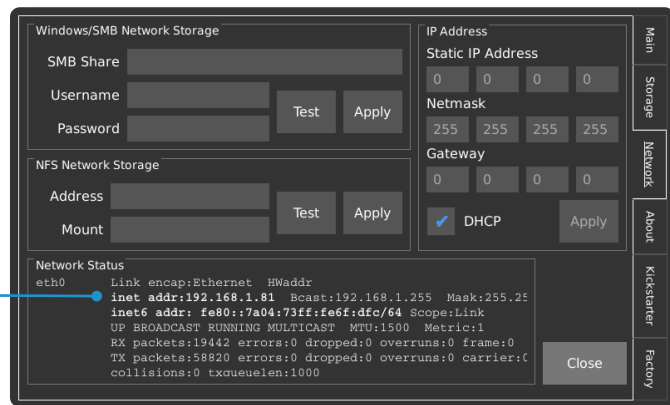

NAVIGATING THE CAMERA'S WEBPAGE: MAIN

The **Main** page of the Chronos control webpage offers similar functionality to the back of camera interface with an alternative layout of configuration and control settings that will adapt to the size of a PC, smartphone, or tablet's screen size.

The viewfinder window on this page updates at approximately 1 frame per second. For a real-time view of the camera's viewfinder, please see instructions on how to configure an RTSP network stream.

The screenshot shows the Chronos control webpage interface. At the top, there is a navigation bar with the Chronos logo and the text "HIGH-SPEED CAMERAS by Kron Technologies". Below the logo, there is a navigation menu with options: Main, Play & Save, Settings, I/O Config, Documentation, and a Menu icon. The main content area is divided into two sections. On the left is a large video window displaying a live sensor output of a water splash with an orange slice. Below this window are several control buttons: Record, 46% battery, Black Calibration, Zebra Stripes, and Focus Peaking. On the right is a settings panel with various controls: Exposure (Shutter) with a slider and values 349.5, 100.0, 223.1, and MAX; Analog Gain set to 12dB (x4); Resolution set to 800 x 600 with a Presets dropdown; Sensor Coverage with a blue square indicator; Offset set to 576 x 240 with a Center button; Frame Rate set to 4352.37 with MAX and Apply buttons; White Balance set to 5600K with a Set Custom button; and a Save Video section with a Location dropdown, Size/Used/Available indicators, a File Name input field, and a File Format dropdown with a Save button. Five callout lines point to specific features: "Web Application Programming Interface (API) Documentation" points to the Documentation menu item; "Dropdown menu for narrow screens (ie. Smartphones)" points to the Menu icon; "Record Settings" points to the Record button; "Display of live sensor output at 1 frame per second." points to the video window; and "Full Video Save Shortcut" points to the Save button in the Save Video section.

Web Application Programming Interface (API) Documentation

Dropdown menu for narrow screens (ie. Smartphones)

Record Settings

Display of live sensor output at 1 frame per second.

Full Video Save Shortcut

NAVIGATING THE CAMERA'S WEBPAGE: PLAY & SAVE

Navigating to the **Play & Save** page of the Chronos control webpage offers similar functionality to the **Play** screen on the back of camera interface. Additionally, the **Storage Device** section of this page offers insight into the remaining storage space on connected external storage device.

The **Download From Camera** dropdown menu provides a list of image and video files on the connected external storage device. After the desired footage is saved to the external storage device, selecting a file in **Download From Camera** dropdown menu will download the file to the PC.

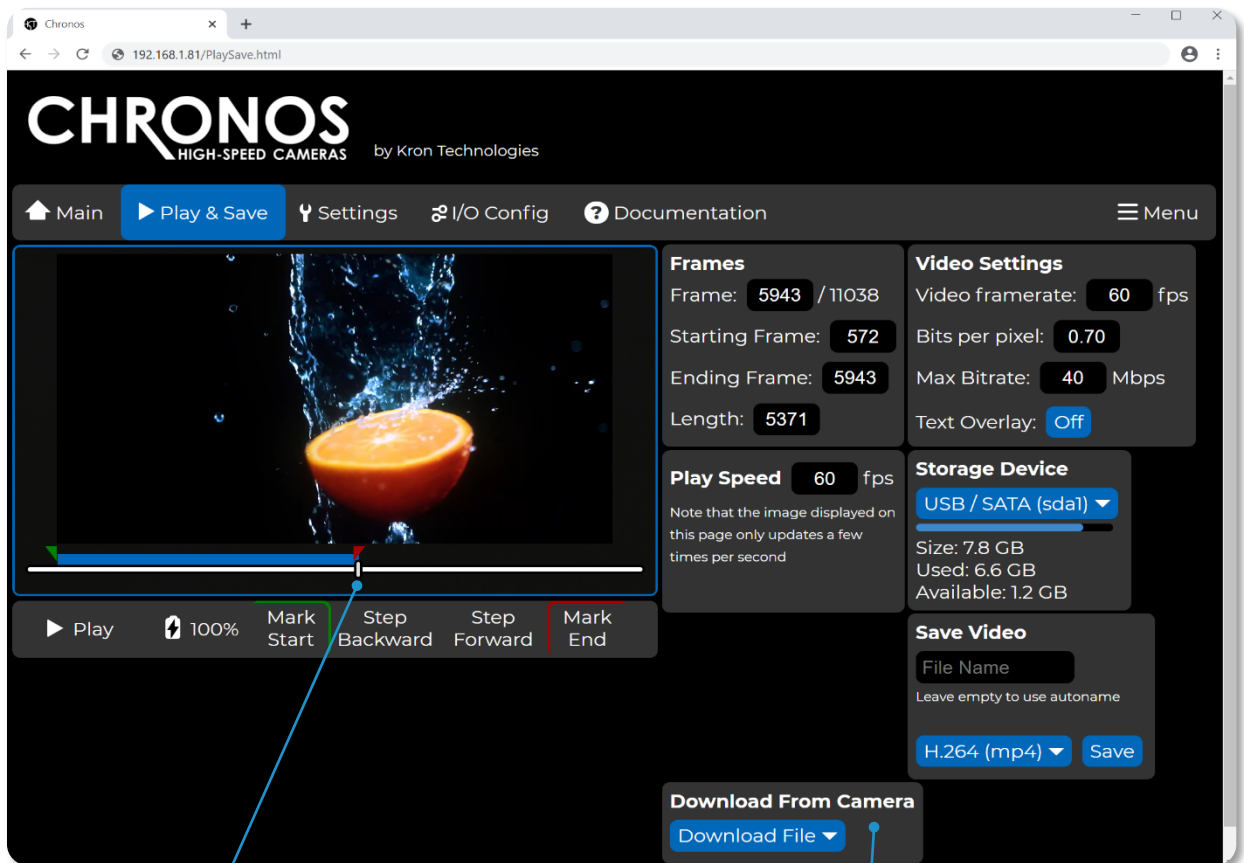

Frame Position Slider

**Download Files
Directly to PC**

NOTE: The video output on the camera's LCD display, as well as any connected HDMI displays, will be switched to the Playback mode if the **Play & Save** page is accessed from the web control interface. It will be switched back to the live display of the image sensor's output upon navigating to the **Main** page.

NAVIGATING THE CAMERA'S WEBPAGE: SETTINGS

Navigating to the **Settings** page of the Chronos control webpage allows for the configuration of commonly used settings from the **Util**, **White Balance**, and **Record Settings -> Trigger Delay** screens on the back of camera interface.

Additionally, this page allows for the configuration of the webpage's behavior and theming.

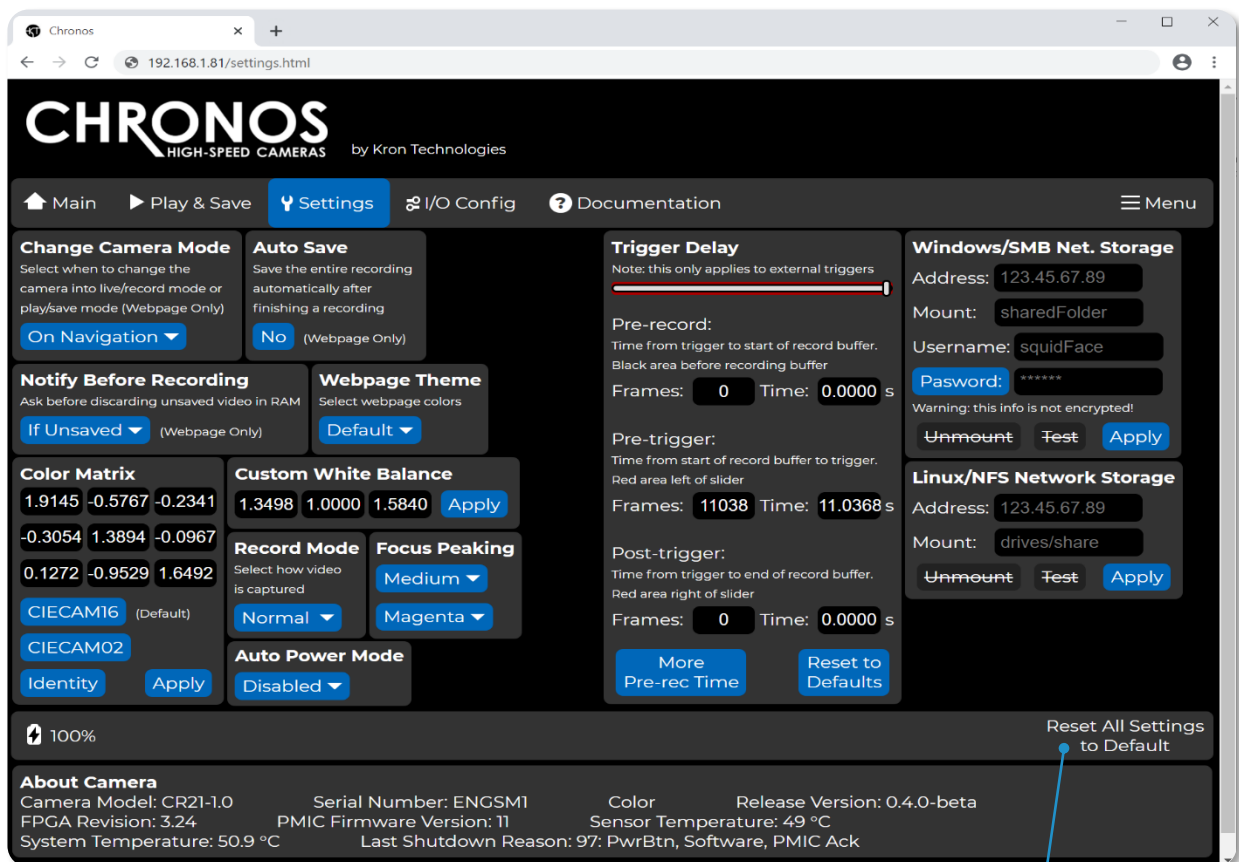

Reset All Settings to Default

NAVIGATING THE CAMERA'S WEBPAGE: I/O CONFIG - SIMPLE

The **I/O Config** screen is separated into two sections: **Simple Configuration** and **Advanced Configuration**. Simple Configuration corresponds closely to the **Trigger I/O Settings** screen on the back of camera interface, while Advanced Configuration allows for full control over each input, action, and output of the camera's I/O system.

Real-time level indicator (HIGH/LOW)

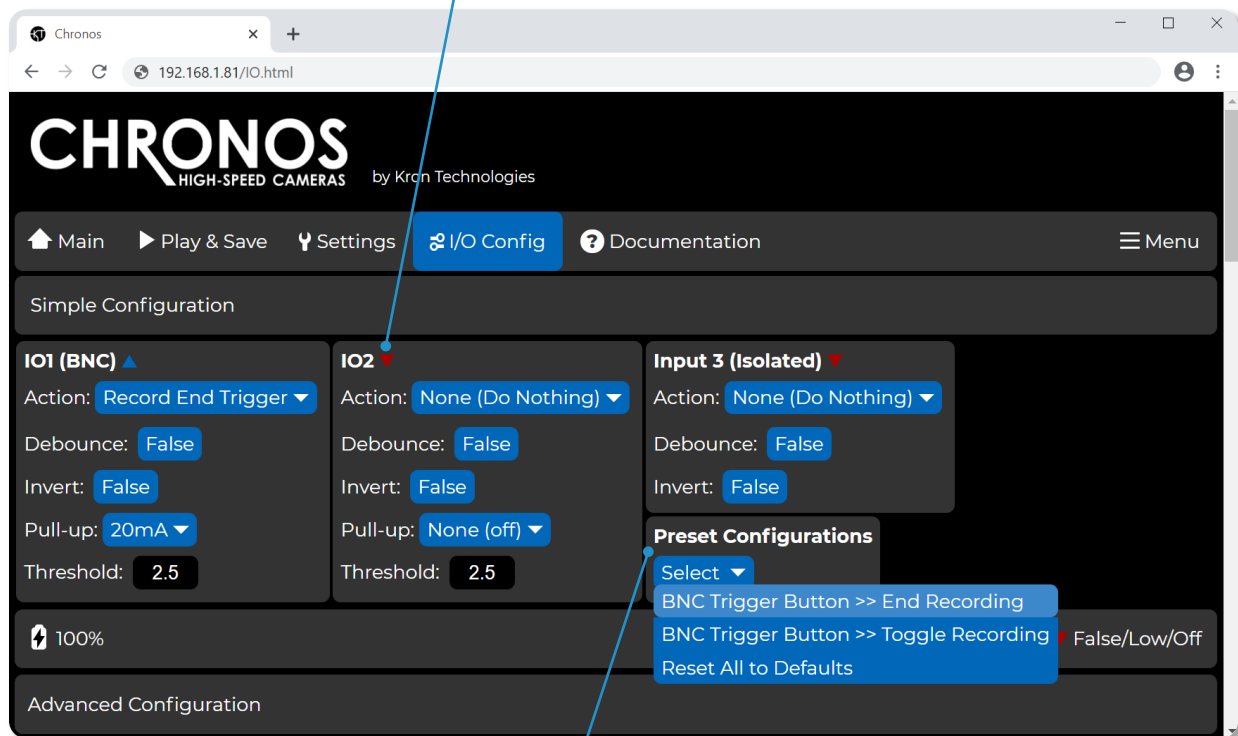

Preset Triggering Configurations

For parameters that can be configured under the **Simple Configuration** section, it is sufficient to follow guidelines as discussed in the **Triggering** section of this user manual. Additionally, the **Preset Configurations** dropdown allows for fast and convenient configuration of two common cases.

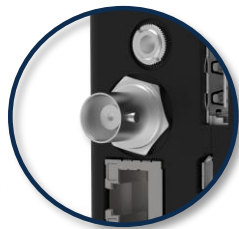

The **BNC Trigger Button >> End Recording** preset will configure the camera's I/O system to end a recording once the external trigger button is pushed on I/O1 (BNC).

The **BNC Trigger Button >> Toggle Recording** preset will configure the camera's I/O system to start a recording on the first push of the external trigger button, follow by a stop on the subsequent push of the button.

NAVIGATING THE CAMERA'S WEBPAGE: I/O CONFIG - ADVANCED

Selecting a **Preset Configuration** will automatically change certain parameters under the **Advanced Configuration** section of the webpage, which provides a good set of examples for users who wish to use the advanced sections to configure the camera.

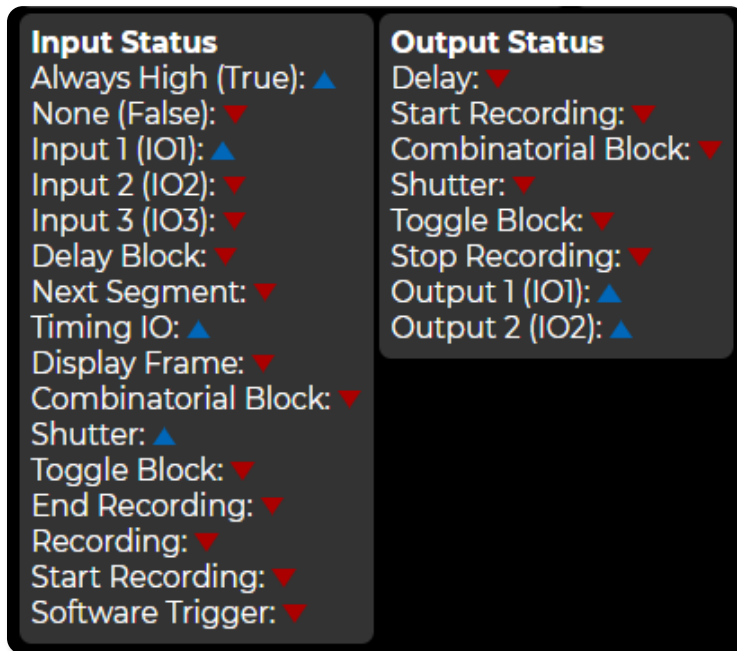

The **Input Status** and **Output Status** boxes show the status of each connection in real time. The arrows will change to signify a HIGH or LOW signal based on how the Camera is configured with parameters on the rest of the I/O Config page.

NOTE: If advanced configurations of the I/O settings for the camera result in unintended operation, the settings can be reverted to defaults by selecting **Reset All to Defaults** from the **Preset Configurations** dropdown list.

The **Combinatorial Block** section of the **Advanced Configuration** allows users to connect the logic of multiple input sources together to produce an output that triggers a recording. Changing parameters will change the arrows depicted in the logic gate legend in real-time to reflect the most current configuration.

Combinatorial Block

Combinatorial OR1 ▼
 Combinatorial OR2 ▼
 Combinatorial OR3 ▼
 Combinatorial AND ▲
 Combinatorial XOR ▼

Combinatorial Out ▼

Combinatorial OR 1 ▼
 Select a connection for the 1st combinatorial OR input
 Source: None (False) ▼
 Debounce: False
 Invert: False

Combinatorial OR 2 ▼
 Select a connection for the 2nd combinatorial OR input
 Source: None (False) ▼
 Debounce: False
 Invert: False

Combinatorial OR 3 ▼
 Select a connection for the 3rd combinatorial OR input
 Source: None (False) ▼
 Debounce: False
 Invert: False

Combinatorial XOR ▼
 Select a connection for the combinatorial XOR input
 Source: None (False) ▼
 Debounce: False
 Invert: False

Combinatorial AND ▲
 Choose what triggers the Combinatorial AND input
 Source: Always High (True) ▼ ▲
 Debounce: False
 Invert: False

Under the **Advanced Configuration** individual preferences for behaviors titled in each box below can be configured. Each box contains a descriptor, an option to select the source responsible for the action, the ability to set a *Debounce* to mitigate against mechanical contact bounce, and an *Invert* signal.

Trigger ▼
 Choose what causes a 'Trigger' event
 Source: Input 1 (IO1 in) ▼
 Debounce: False
 Invert: False

Start Recording ▼
 Choose what will start a recording
 Source: None (False) ▼
 Debounce: False
 Invert: False

Stop Recording ▼
 Cause the recording to stop
 Source: None (False) ▼
 Debounce: False
 Invert: False

Toggle ▼ Set
 Choose what will 'Set' the toggle block
 Source: None (False) ▼
 Debounce: False
 Invert: False

Toggle ▼ Flip
 Choose what will 'Flip' the toggle block
 Source: None (False) ▼
 Debounce: False
 Invert: False

Toggle ▼ Clear
 Choose what will 'Clear' the toggle block
 Source: None (False) ▼
 Debounce: False
 Invert: False

Shutter ▼
 Choose what affects the shutter
 Source: None (False) ▼
 Debounce: False
 Invert: False
 Mode: Frame Trigger ▼

Delay ▼
 Choose what causes the Delay Timer to run
 Source: None (False) ▼
 Debounce: False
 Invert: False
 Time: 0.000

Output 1 (IO1 out) ▲
 Choose when IO1 out does something
 Source: Always High (True) ▼ ▲
 Debounce: True
 Invert: False
 Drive Strength: Off ▼

Output 2 (IO2 out) ▲
 Choose when IO2 out does something
 Source: Always High (True) ▼ ▲
 Debounce: False
 Invert: False
 Drive Strength: Off ▼

Annex A – Hardware

CAMERA'S BACK

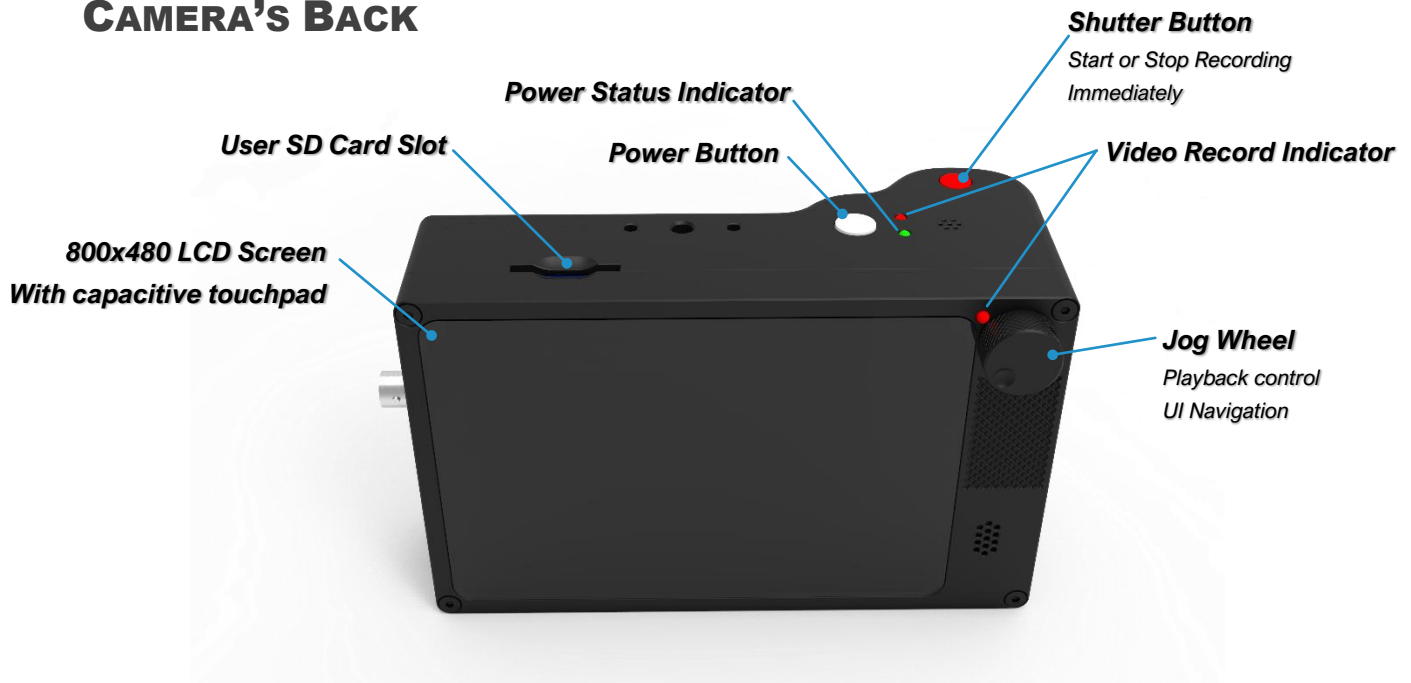

POWER BUTTON

- Press to turn on the camera
- To shut down the camera, press the Power button for 1 second, then release. A pressing lasting for less than 0.5 seconds will be ignored.
- Holding for 4 seconds forces a hard power down. Do this only if the software has crashed and the camera is not responding. Like a PC, the camera needs to shut down properly or file system damage may occur, requiring a re-flash of the OS SD card.

SHUTTER BUTTON

- Starts or stops recording. The shutter button is not affected by trigger settings, including trigger delay.

RECORD INDICATORS (2)

- Illuminate to indicate that the camera is recording.

POWER STATUS INDICATOR

- *Indicates the presence of AC power and the charge status of the battery.*

LED	Indication
Un-Lit	No AC Power Connected
Solid Yellow	Charging, less than 80% charged
Alternating Green/Yellow	Charging, more than 80% charged
Green	Battery fully charged

JOG WHEEL

- *Used for playback control, adjusting shutter speed, and UI navigation and input.*
- *During playback, moves playback 1 frame per detent (rotation click).*
- *Press and hold the dial clicked in to move fast (40 frames per detent)*
- *On the Main screen, rotation adjusts shutter speed.*
- *During UI navigation, rotation cycles through the widgets on the user interface, and a click will activate the highlighted widget.*

SD CARD SLOT

- *Videos can be saved to the card in this slot.*
- *For fastest saving, a Class 10 or faster SD card is recommended, however, any properly formatted SD card will work. (FAT32, EXT2 and EXT3 file systems are supported)*

CAMERA'S SIDE

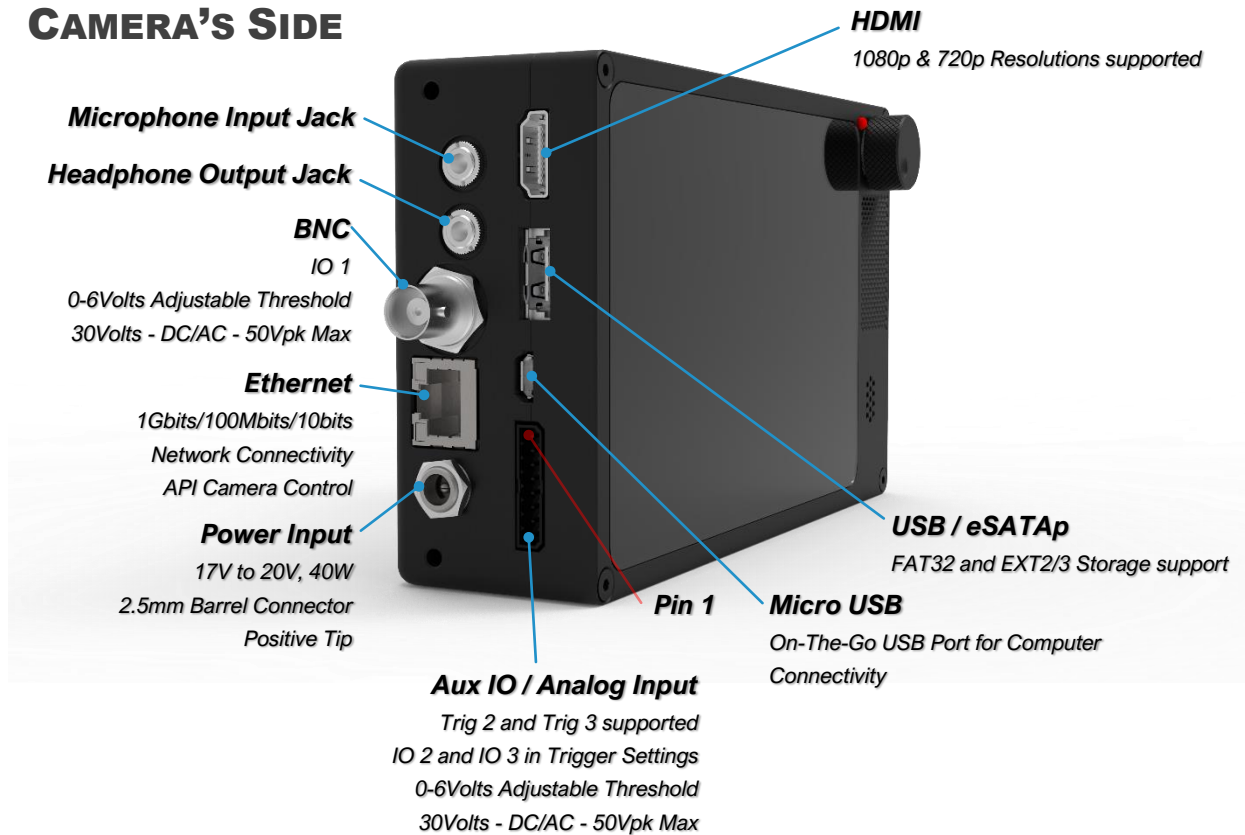

HDMI

- When connected to a monitor via HDMI, the camera will automatically output a video signal during live video feed, recording, and playback, but not during saving. It will output a 1080p signal over HDMI by default.
- If the monitor supports 720p, but not 1080p, then 720p will be used.

AUDIO IO

- Not supported in current software, but the hardware is present in all cameras.
- Please sign up for the Krontech newsletter here:
<https://www.krontech.ca/chronos-newsletter/>.
- You will receive emails about software updates, including those for audio support.

USB/eSATA

- This port accepts both USB type A and eSATA devices. USB mass storage devices such as flash drives and hard drives can be connected to this port.
- This port is also able to supply power using an eSATAp cable.

NOTE: Most 2.5" hard drives and SSDs will work with the Chronos, but most 3.5" drives will not. This is because the eSATAp port only supplies 5v, not 12v.

BNC

- The BNC connector can be used to synchronize multiple cameras, or to connect the camera to a variety of equipment, including trigger cables.

MINI USB OTG

- Can be used to connect a camera directly to a computer, and to control it from the computer, using a USB-A to Mini-USB cable.
- A tutorial on setting up a camera for network control can be found here: <https://www.krontech.ca/tutorials/>

NOTE: USB mass storage devices, such as flash drives and hard drives, will not work on this port.

ETHERNET

- Can be used to remotely control the camera using the Krontech's API or by using the webserver interface. See the Network Interface (Pg. 29) section of the manual for more details.

Aux IO

- Trigger and Analog inputs.
- Only trigger inputs are supported in the current software.
- The matting plug is Phoenix Contact part number **1778890**

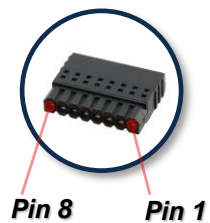

Pin	Function
1	Analog In 1
2	Common
3	Analog In 2
4	Common
5	Trigger IO 2
6	Common
7	Isolate Trigger Input 3 (+)
8	Isolate Trigger Input 3 (-)

POWER INPUT

- 17-20V DC 40W, 5.5/2.5mm barrel jack, positive tip.

CAMERA'S BOTTOM

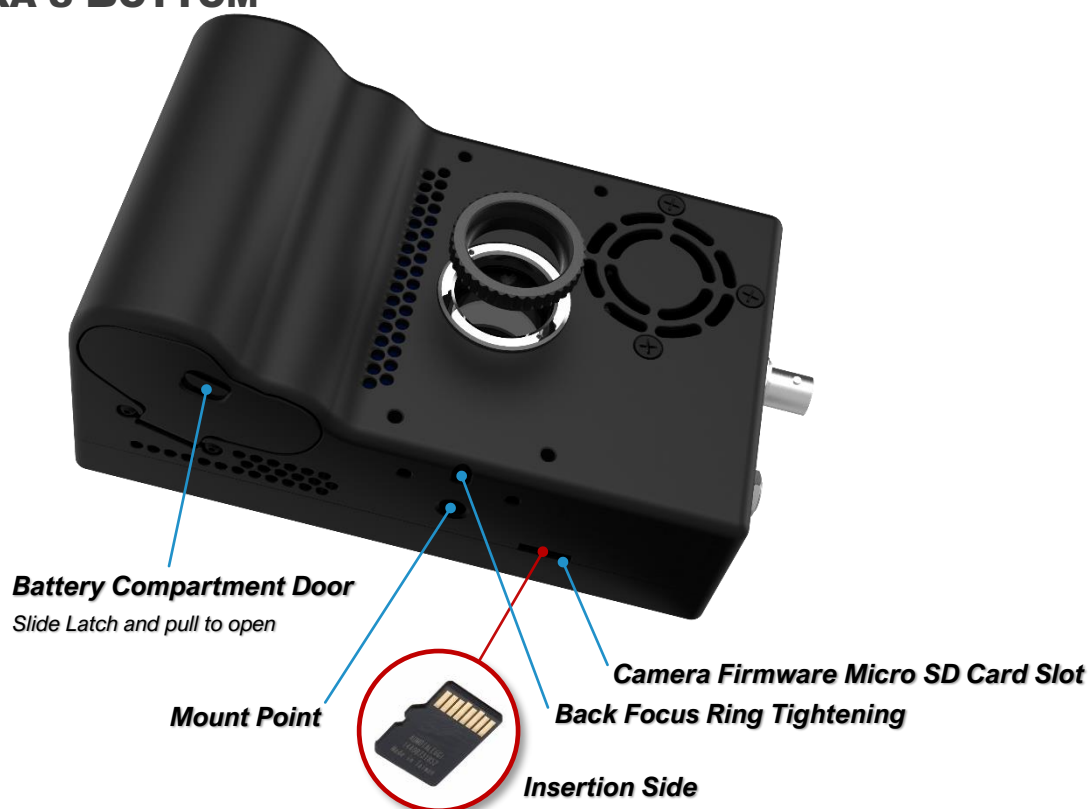

SYSTEM SD SLOT & CARD

- Bootable media for the camera that holds the camera's operating system.
- During software upgrades, the camera writes new files to this card.

IMPORTANT: A Class 10 or faster SD card is recommended for the fastest video saving. However, any properly formatted SD card will work. (FAT32, EXT2 and EXT3 file systems only.)

WARNING: Make sure the card is correctly oriented when inserting it into the System SD Card Slot. The card is very difficult to retrieve if flipped or forced.

MOUNT POINT

- Standard mount point for the camera, to attach tripods or other equipment.

BACK-FOCUS LOCK SCREW

- Prevents the Back-Focus ring from moving. See *Back-Focus Adjustment* (Pg. 44).

BATTERY COMPARTMENT

- To open, push latch up and pull out.
- Holds an EN-EL4a 11.1V 2500mAh or 3100mAh battery during normal operation.

Annex B - Lenses

LENS MOUNT & ADAPTER

The Chronos 1.4 & 2.1-HD are CS mount cameras. C mount lenses can be used with the included adapter. Other lens types such as F, EF, and PL can be used with appropriate adapters to convert them to C mount. Common lenses available for the camera are listed below, along with the adapters required to use them.

Lens Model	Lens Mount	Adapter Required
COMPUTAR 12.5-75mm f/1.2 Zoom	C	CS - C
COMPUTAR 12mm f/1.4 Prime	C	CS - C
6-60mm f/1.7 Zoom (will Vignette)	CS	None
2.8-12mm f/1.4 Zoom (will Vignette)	CS	None
COMPUTAR 8mm f/1.4 Prime	C	CS - C
FUJIAN 35mm f/1.7	C	CS - C
Microscope Lens	C	CS - C
SIGMA 24-70mm f/2.8	F	F - C



2.8-12mm f/1.4 Zoom



**COMPUTAR
8mm f/1.4 Prime**



**COMPUTAR
12mm f/1.4 Prime**



**COMPUTAR
12.5-75mm f/1.2 Zoom**



**FUJIAN
35mm f/1.7**



6-60mm f/1.7 Zoom



Microscope Lens



**SIGMA
24-70mm f/2.8**

LENS SELECTION

Lenses vary in their image circle, which is the amount of the image sensor they can cover:

- The Chronos 1.4 uses a 2/3" image sensor (actual sensor dimensions are 8.45mm x 6.76mm).
- The Chronos 2.1-HD uses 4/3" image sensor.

Lenses designed for smaller sensors can be used, however the image will not cover the entire sensor. This results in 'Vignetting', which is a black ring around the border of the video.

NOTE: Sample images for each lens offering by Kron Technologies may be found at <https://www.krontech.ca/store/Lenses-c21981409>

BACK-FOCUS ADJUSTMENT

- *Back-Focus is the distance between the lens mounting flange and the image sensor. It controls how lenses focus and must be set correctly.*
- *The camera is set from the factory for the COMPUTAR 12.5-75mm zoom lens. This setting is correct for most other lenses, but if you are experiencing problems with focus, this is the first thing to check.*

To correctly set Back-Focus for your lens, follow these steps:

PRIME LENSES (NON-ZOOM)

1. *Use a lens that has graduated focus (markings showing the focal distance). You cannot properly adjust Back-Focus on non-graduated-focus lenses.*
2. *Set the lens to focus at infinity.*
3. *Loosen the Back-Focus lock screw on the bottom of the camera by about 1 turn using the included 2mm Allen key.*
4. *Aim the camera at an object very far away, such as a distant tree.*
5. *Rotate the entire lens, allowing the CS ring to screw in or out. Adjust the rotation until best focus is obtained on the distant object.*
 - a. *Do not adjust the focus ring on the lens.*
 - b. *If the CS ring will not rotate far enough, check to see if your lens requires a CS-C adapter. Please refer to Pg. 43 for additional details.*
6. *Tighten the Back-Focus lock screw, finger-tight.*

ZOOM LENSES (PARFOCAL LENSES ONLY)

1. *Zoom the lens into maximum zoom.*
2. *Adjust for best focus on an object within the normal focus range, perhaps a few meters away.*
3. *Zoom the lens all the way out.*
4. *Loosen the Back-Focus lock screw on the bottom of the camera by about 1 turn using the included 2mm Allen key.*
5. *Rotate the entire lens allowing the CS ring to screw in or out. Adjust the rotation until best focus is obtained on the same object.*
 - *Do not adjust the focus ring on the lens.*
 - *If the CS ring will not rotate far enough, check to see if your lens requires a CS-C adapter. Please refer to Pg. 43 for additional details.*
6. *Tighten the Back-Focus lock screw, finger-tight.*
7. *Repeat steps 1 to 6 until the lens is in focus when zoomed in and when zoomed out, without adjusting the focus control while zooming.*

Annex C – IR Filter

IR FILTER

An IR Filter (Infrared Cut-Off Filter) is standard on all cameras. This filter will cut-off wavelengths above 650nm.

The Color Chronos 1.4 benefits from the IR Filter because of improved color reproduction.

All color pixels (red, green, and blue) have some parasitic sensitivity to IR light, which results in washed-out images, especially in daylight or under incandescent lamps. The IR Filter removes this invisible light.

The Monochrome Chronos 1.4 benefits from the IR filter when recording objects that emit large amounts of IR light, such as glowing objects or sparks. The IR light will focus differently than visible light in most lenses, resulting in blur. The IR Filter removes this light, less total light hits the image sensor, and sensitivity is reduced. The result is sharper images.

REMOVING THE IR FILTER

- You can remove the IR Filter for cleaning, or for applications that require IR sensitivity.
- You can also add your own filter, of any desired wavelength.
- The camera accepts 15x15mm square filters, of 1.1mm thickness.

WARNING: When handling, it is important that you do not scratch the filter. Use the necessary tools and cleaning products to avoid damage.

To remove the filter, follow the steps below, or see the tutorial at <https://www.krontech.ca/wp-content/uploads/2020/01/IR-Filter-.pdf> :

1. Loosen the Back-Focus adjustment screw on the bottom of the camera about 1 turn using the included 2mm Allen key.
2. Unscrew the CS ring from the camera.
3. Using a 1.5mm Allen key (not included), remove the two screws that hold in the IR Filter case.
4. Using tweezers, remove the IR Filter case.
5. Remove the IR Filter. To avoid damaging it, a vacuum pick-up tool is best, but tweezers can be used, if you are careful. It is important to remember which side of the filter faces out of the camera, as the filter has an optimum direction for light travel.
7. Store the IR filter where it will not be scratched, such as in a paper envelope.
8. Reinstall the filter case using the two screws.
9. Reinstall the CS ring.
10. Tighten the Back-Focus adjustment screw, finger-tight. Be careful not to over-tighten it.
11. Perform a Back-Focus adjustment. Reinstalling the CS ring to its original position will not work, as
12. the Back-Focus is changed by refraction in the IR Filter glass.

Annex D – Trigger

Inputs/Outputs

TRIGGER INPUTS/OUTPUTS

The Chronos 1.4 & Chronos 2.1HD have two trigger input/outputs, and one isolated trigger input. Trigger IO is used by the cameras to communicate to other equipment such as lights or external triggers. For example, if you have several cameras set up, you can use a trigger to start or stop all of them at once.

TRIGGER IO 1 AND 2

- These non-isolated triggers are referenced to the camera's power and chassis ground and can provide either input functionality with adjustable threshold (0-6.6V), or 5V TTL level output.
- They are protected against damage when connected to voltages of 30V DC/AC RMS and +/- 50V peak.
- The 20mA output drive is suitable to directly drive terminated coaxial cable, and will produce 1V into 50Ω, with rise and fall times of (typically) 10ns or faster. Unterminated operation will result in a much slower fall time.

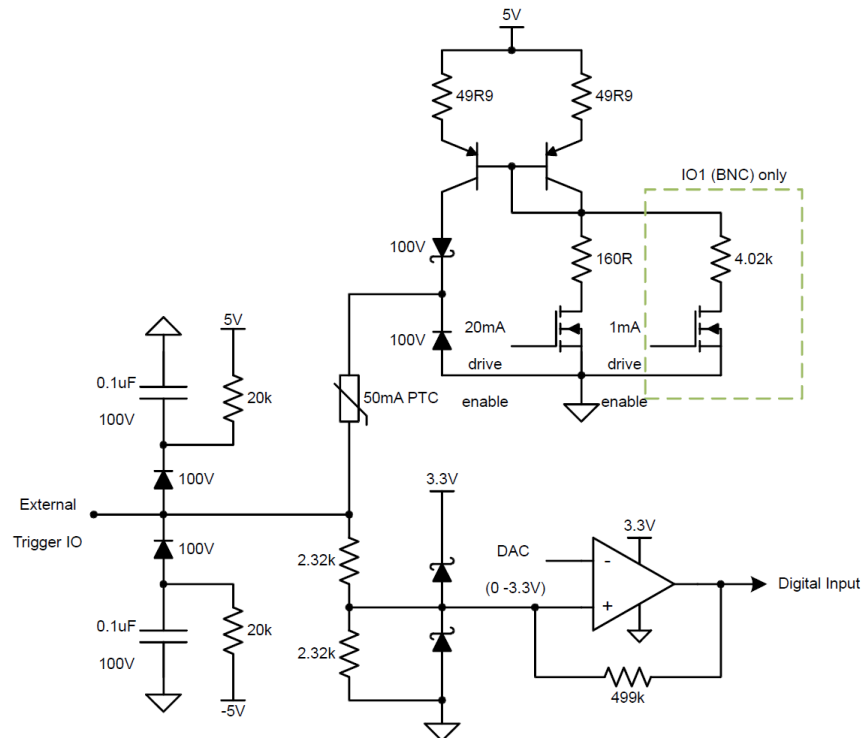

TRIGGER IN 3

- *This input is isolated via an optocoupler.*
- *A logic low input is a voltage from -30 to 1V, and a high-level input is a voltage of 3 to 30V.*
- *Voltages between these ranges (1 to 3V) are undefined.*
- *This input has built-in resistors to correctly drive the optocoupler and is protected from differential voltages up to 30V DC/RMS AC and +/- 50V peak.*
- *Trigger In 3 is rated for SELV (Safety Extra Low Voltage) circuits only, up to a maximum common mode voltage of 60V above ground.*

DANGER: The isolated input is not rated for safety isolation. Never use any of these inputs to connect directly to mains-reference circuits. If triggering from AC mains is needed, external safety isolation (such as a transformer) is required.

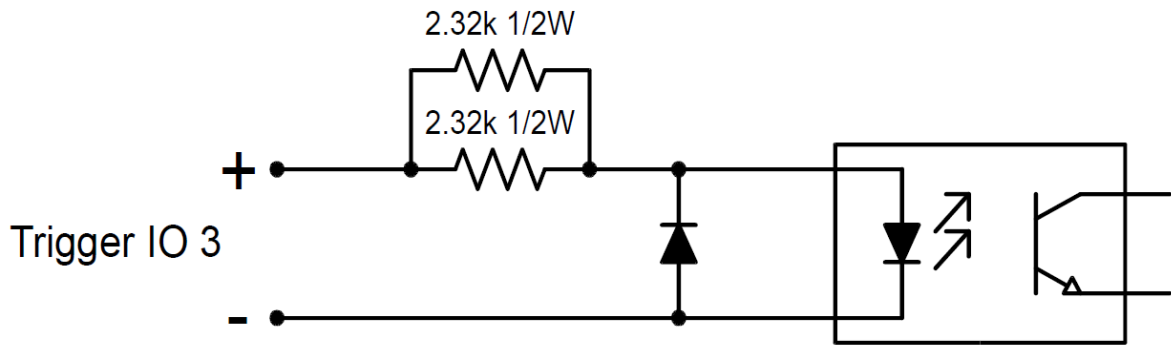

Annex E – Troubleshooting

<i>Symptom</i>	<i>Possible Problem</i>	<i>Solution</i>
Camera won't power on	No Power	Insert battery or connect to mains power
	Crash	Remove battery and AC adapter for 10seconds, then reconnect and power on.
	Wrong AC Adapter Voltage	Ensure that the AC Adapter is providing between 17V and 20V DC, positive tip.
Camera won't power on, and Power Status indicator flashes orange when power button is pressed	Shipping Mode is enabled	The AC adapter must be plugged in to turn the camera on while in Shipping mode, even if a battery is inserted. It will not be required for subsequent power-ons.
Battery won't charge	Battery inserted after AC connected	Unplug AC adapter from camera, then re-plug.
	Wrong AC Adapter voltage	Ensure that the AC Adapter is providing between 17V and 20V DC, positive tip.
Battery indicator drops very fast	low quality or failing battery	Replace battery.
Power status indicator flashes red/green continuously	Power controller in recovery mode	Turn the camera off, remove the battery and disconnect the AC adapter for 10 seconds. When reconnecting power or inserting battery, ensure the power button is not pressed until after the LED flashing stops.
	Power controller firmware corrupt	If the above solution doesn't fix the problem, contact Kron Technologies at support@krontech.ca
Can't trigger recording end.	IO screen has extra pullup on	Confirm that the only pullup enabled is the one for the trigger that is in use.
Horizontal or vertical lines show up in video.	A Black Calibration was not done after changing shutter speed, resolution or gain	Perform a Black Calibration after every change of resolution, shutter speed or gain. Please see the Black Calibration section for more details on how to calibrate the camera.
Extremely blurry image, can't get close to proper focus.	Incorrect lens adapter installed.	Check if lens is CS or C mount to determine proper adapter to use. Please see the "Annex B" for more details.
Focus slightly wrong, proper focus out of range.	Back-Focus mis-adjusted	Re-adjust Back-Focus. Please see the "Annex B" for more details.
	Lens limitation	The Computar 12.5-75mm lens, among others, is slightly soft at fully wide aperture. Close aperture slightly and retry. Try f/2 or smaller.

Lens doesn't maintain consistent focus while zooming.	Back-Focus mis-adjusted	Re-adjust Back-Focus. Please see the "Annex B" for more details.
	Lens is not parfocal	Some lenses, especially lower-end lenses such as the 6-60mm and 2.8-12mm lenses, do not maintain focus during zoon, so focus needs to be adjusted after zooming.
Black ring around image/Corners of image are dark. (Vignetting)	Lens is too small for the sensor	Some lenses, especially lower-end lenses such as the 6-60mm and 2.8-12mm lenses don't cover the image sensor. Change to a different lens with a larger image circle.
Negative ghost image visible over normal image	Black Calibration was done without lens cap on, or with aperture open	Perform Black Calibration again by closing the aperture fully or covering the lens. Please see the Black Calibration section for more details on how to calibrate the camera.
Camera shows a black or still image	Trigger mode is either 'Exposure Trigger' or 'Shutter Gating', but there is no external signal bring received	If you do not wish to use either of these modes, go to Trigger/IO Settings and switch back to Record End Trigger for normal operation
		If you do wish to use one of these modes, check that you have the correct input selected, or connect a signal generator and send a signal of frequency equal to the desired frame rate.
Dark band when there is a bright object shown on the image	Extreme exposure	Reduce exposure, or move the bright object out of frame.

Annex F – Specifications

CHRONOS 1.4

Camera	Imaging	1280 x 1024 1069FPS
	Memory	8GB, 16GB, 32GB
	Record Time	4 Sec (8GB), 8 Sec (16GB), 16 Sec (32GB)
	Lens Mount	CS mount, C mount with included adapter
	Back-Focus	Field adjustable
	IR Filter	650nm, removable, 15mm x 15mm x 1.1mm
	Display	5" 800 x 480 Capacitive touchscreen
	Enclosure	Anodized CNC machined aluminum
	Cooling	Active cooling, variable-speed fan
	Dimensions	155mm x 96mm x 67.3mm (6.11" x 3.78" x 2.65") without lens
	Weight	1.06Kg (2.34lbs) without lens
Video Formats	H.264	Industry standard mp4 files at bitrates up to 60Mbps
	CinemaDNG Raw	Standard Adobe CinemaDNG raw files
Image Sensor	Resolution	1280x1024 @ 1069FPS
	Speed	1.4Gpx/s, full through-put down to 320 pixels image width.
	Dimensions	8.45mm x 6.76mm
	Pixel Pitch	6.6um
	Sensitivity (ISO)	Color: ISO 320 to 5120 Mono: ISO 740 to 11840
	Shutter	Electronic global shutter, 1/fps to 1us (1/1,000,000s)
	Dynamic Range	56.7 dB

	Bit Depth	12-bit
Battery	Type	EN-EL4a
	Run Time	1.5 hours recording (typical)
	Charge Time	2 hours (0-80%)
IO	Power Input	17-20V 40W 5.5/2.5mm barrel jack, positive tip
	Network	Gigabit Ethernet
	Trigger	Two Trigger inputs/frame probe outputs (BNC & Aux) Adjustable Input Threshold 0 to 6.6Volts Electrically isolated trigger input (Aux Connector)
	Audio	Microphone/Line input, headphone output
	Video	HDMI output, video only HDMI output, video+menus
	USB	2x USB hosts ports (one on mini-B via USB OTG cable)
	SATA	eSATA 3G
	Analog Input*	1MSa/s 12-bit, 200Khz bandwidth, +/- 1V full scale
Trigger Modes	Normal Triggered	Camera records until a defined delay after trigger
	Trigger Start	Camera starts recording after a defined delay after a trigger
Trigger Source	Electrical	0-6.6V threshold, optional button debounce and pullup
	Audio*	Trigger on loud sounds
	Acceleration*	Trigger on camera motion, tilt or shock
	Image*	Trigger on image changes

Recording Modes	Normal	Records into the circular buffer. Once a trigger occurs, video can be reviewed and saved.
	Segmented	RAM is divided into segments, each recording as in the Normal mode. Number of segments is use selectable.
Recording Modes	Gate Burst	Frames are captured while trigger is active
	Continuous	Video is saved continuously at up to 60FPS to mp4 files on removable storage. Operates like a normal video camera.
	Run-n-Gun*	Bursts of video are saved to RAM while holding down the shutter button. Video is saved to storage devices automatically. More bursts can be captured simultaneously while video is saving.
	Normal + Continuous	High-speed video is recorded to the RAM buffer, while simultaneous 60FPS video is saved to removable storage.
Shutter Timing	Normal	Frame rate & exposure time are controlled by the camera
	Exposure Trigger	A single frame is captured on each rising or falling edge of an external input. Exposure duration is controlled by camera.
	Shutter Gating	Image sensor shutter is directly controlled by an external input, exposing while the input is active.
Assistive	Focus Peaking	Highlights sharp edges to aid focusing
	Zebras	Rolling diagonal lines indicate clipped (overexposed) areas.
	Focus Aid	Zooms in to allow easier focusing
	Overlay	Display frame and time information on top of footage

*These features will be added in future software updates.

CHRONOS 2.1-HD

Camera	Imaging	1920 x 1080 1000FPS
	Memory	8GB, 16GB, 32GB
	Record Time	2.7 Sec (8GB), 5.5 Sec (16GB), 11 Sec (32GB)
	Lens Mount	CS/C mount, Nikon F, Canon EF with adapter
	Back-Focus	Field adjustable
	IR Filter	650nm, removable, 24mm x 16mm x 1.1mm
	Display	5" 800 x 480 Capacitive touchscreen, 1000nit daylight visible
	Enclosure	Anodized CNC machined aluminum
	Cooling	Active cooling, variable-speed fan
	Dimensions	155mm x 96mm x 67.3mm (6.11" x 3.78" x 2.65") without lens
Weight	1.06Kg (2.34lbs) without lens	
Video Formats	H.264	Industry standard mp4 files at bitrates up to 60Mbps
	CinemaDNG Raw	Standard Adobe CinemaDNG raw files
Image Sensor	Resolution	1920 x 1080 @ 1000FPS
	Speed	2.1Gpx/s
	Dimensions	19.2mm x 10.8mm (4/3" format)
	Pixel Pitch	10um
	Sensitivity (ISO)	Color: ISO 500 base Mono: ISO 1000 base
	Shutter	Electronic global shutter, 1/fps to 10us (1/100,000s)
	Dynamic Range	10.3 stops (62.4 dB) (preliminary)
	Bit Depth	12-bit

Battery	Type	EN-EL4a
	Run Time	1.5 hours recording (typical)
	Charge Time	2 hours (0-80%)
IO	Power Input	17-20V 40W 5.5/2.5mm barrel jack, positive tip
	Network	Gigabit Ethernet
	Trigger	Two Trigger inputs/frame probe outputs (BNC & Aux) Adjustable Input Threshold 0 to 6.6Volts Electrically isolated trigger input (Aux Connector)
	Audio	Microphone/Line input, headphone output
	Video	HDMI output, video only HDMI output, video+menus
	USB	2x USB hosts ports (one on mini-B via USB OTG cable)
	SATA	eSATA 3G
	Analog Input*	1MSa/s 12-bit, 200Khz bandwidth, +/- 1V full scale
	Trigger Modes	Normal Triggered
Trigger Start		Camera starts recording after a defined delay after a trigger
Trigger Source	Electrical	0-6.6V threshold, optional button debounce and pullup
	Audio*	Trigger on loud sounds
	Acceleration*	Trigger on camera motion, tilt or shock
	Image*	Trigger on image changes

Recording Modes	Normal	Records into the circular buffer. Once a trigger occurs, video can be reviewed and saved.
	Segmented	RAM is divided into segments, each recording as in the Normal mode. Number of segments is use selectable.
Recording Modes	Gate Burst	Frames are captured while trigger is active
	Continuous	Video is saved continuously at up to 60FPS to mp4 files on removable storage. Operates like a normal video camera.
	Run-n-Gun*	Bursts of video are saved to RAM while holding down the shutter button. Video is saved to storage devices automatically. More bursts can be captured simultaneously while video is saving.
	Normal + Continuous	High-speed video is recorded to the RAM buffer, while simultaneous 60FPS video is saved to removable storage.
Shutter Timing	Normal	Frame rate & exposure time are controlled by the camera
	Exposure Trigger	A single frame is captured on each rising or falling edge of an external input. Exposure duration is controlled by camera.
	Shutter Gating	Image sensor shutter is directly controlled by an external input, exposing while the input is active.
Assistive	Focus Peaking	Highlights sharp edges to aid focusing
	Zebras	Rolling diagonal lines indicate clipped (overexposed) areas.
	Focus Aid	Zooms in to allow easier focusing
	Overlay	Display frame and time information on top of footage

*These features will be added in future software updates.

Annex G – Maintenance & Care

OPTICS

- *Keep the optical area clean when changing lenses by keeping the body and lens mount caps on when the lens is separated from the camera.*
- *If the lens or sensor/IR filter is dusty, remove the dust using clean, dry compressed air, dusting gas, or a dusting squeeze bulb. If dust persists, use a brush or lens pen.*
- *If there is dust under the IR filter, you can remove the filter for cleaning. See [Removing the IR Filter in Annex C](#).*

CAMERA BODY

- *Do not expose the camera to moisture or excessively dusty environments.*
- *Do not expose the camera to molten metal.*
- *The camera body can be cleaned with a lint-free cloth, and optionally a small amount of rubbing alcohol. Do not use excessive liquids as they may enter the camera body.*

SCREEN

- *The touchscreen surface is breakable glass. Do not strike it with hard objects or put excessive pressure on it.*
- *The screen should be cleaned with a lint-free or microfiber cloth.*
- *A small amount of glass cleaner or rubbing alcohol may be applied to the cloth if required. Do not use excessive amounts, and don't spray glass cleaner directly on the camera.*

Annex H – Record Rates & Times

RECORD PRESET VS RECORD DURATION

Maximum recording time for a sample of common resolutions at max FPS.

CHRONOS 1.4

Resolution	Max FPS	Record Time (Sec) (8 GB)	Record Time (Sec) (16 GB)	Record Time (Sec) (32 GB)
1280 x 1024	1069	4.08	8.16	16.33
1280 x 720	1519	4.08	8.17	16.35
1024 x 768	1770	4.11	8.22	16.45
1024 x 576	2357	4.11	8.23	16.47
800 x 600	2871	4.14	8.29	16.59
800 x 480	3586	4.14	8.29	16.58
640 x 480	4434	4.20	8.40	16.81
640 x 240	8810	4.21	8.42	16.85
320 x 240	16682	4.40	8.82	17.64
320 x 180	22086	4.41	8.82	17.66
320 x 96	40413	4.51	9.02	18.04

- *Record duration stays relatively constant as the resolution is lowered because the maximum frame rate is raised.*
- *There is some overhead associated with each frame, so the increase in FPS is not quite linear.*

CHRONOS 2.1-HD

Resolution	Max FPS	Record Time (Sec) (8 GB)	Record Time (Sec) (16 GB)	Record Time (Sec) (32 GB)
1920 x 1080	1000	2.76	5.51	11.02
1920 x 720	1495	2.77	5.53	11.06
1920 x 512	2095	2.78	5.55	11.11
1920 x 360	2963	2.79	5.58	11.16
1920 x 240	4403	2.80	5.60	11.21
1920 x 120	8569	2.89	5.78	11.56
1920 x 96	10569	2.94	5.87	11.74
1440 x 1280	1434	2.56	5.12	10.25
1440 x 720	2142	2.57	5.14	10.29
1440 x 512	2997	2.59	5.18	10.36
1440 x 240	6265	2.63	5.26	10.53
1440 x 96	14825	2.77	5.54	11.08
1280 x 1024	1434	2.88	5.77	11.53
1280 x 720	2142	2.90	5.79	11.59
1280 x 512	2996	2.91	5.82	11.65
1280 x 360	4230	2.93	5.86	11.72
1280 x 240	6265	2.97	5.94	11.89
1280 x 120	12075	3.07	6.14	12.28
1280 x 96	14825	3.14	6.28	12.56
1024 x 768	2531	2.88	5.75	11.50
1024 x 576	3358	2.89	5.77	11.55
800 x 600	4352	2.73	5.47	10.94
800 x 480	5406	2.73	5.47	10.94
640 x 480	5406	3.44	6.88	13.76
640 x 360	7135	3.48	6.95	13.90
640 x 240	10488	3.54	7.07	14.14
640 x 120	19783	3.72	7.43	14.86
640 x 96	24046	3.87	7.74	15.49

RECORD FPS VS RECORD DURATION

Recording time for a sample of resolution at max FPS, half FPS and one-quarter FPS.

CHRONOS 1.4

Resolution	Max FPS	Record Time (Sec) (8 GB)	Record Time (Sec) (16 GB)	Record Time (Sec) (32 GB)
1280 x 1024	1069	4.08	8.16	16.33
1280 x 1024	534	8.16	16.33	32.67
1280 x 1024	267	16.31	32.65	65.33
800 x 600	2871	4.14	8.29	16.59
800 x 600	1435	8.29	16.58	33.18
800 x 600	717	16.57	33.17	66.36
640 x 480	4434	4.20	8.40	16.81
640 x 480	2217	8.39	16.80	33.62
640 x 480	1108	16.79	33.60	67.23

- *The duration that can be recorded is doubled every time the frame rate is halved.*
- *The recording time increase is linear as the frame rate decreases.*

RECORD RESOLUTION VS RECORD DURATION

Recording time for a sample of frame rates as resolution decreased.

CHRONOS 1.4

Resolution	Max FPS	Record Time (Sec) (8 GB)	Record Time (Sec) (16 GB)	Record Time (Sec) (32 GB)
1280 x 1024	1069	4.08	8.16	16.33
640 x 480	1069	16.31	32.65	65.33
320 x 256	1069	65.26	130.62	261.33
800 x 600	2871	4.14	8.29	16.59
400 x 300	2871	16.57	33.17	66.36
192 x 150	2871	66.29	132.67	265.44
640 x 480	4434	4.20	8.40	16.81
320 x 240	4434	16.57	33.16	66.35

- *As the resolution is halved in both height and width, the duration of the recording increases by multiples of 4.*
- *Halving the resolution results in $\frac{1}{4}$ the number of pixels, so 4 times the number of frames can be stored – $800 \times 600 = 480k$ pixels, while $400 \times 300 = 120k$ pixels.*

Annex I – Storage & Shipping

- *Store the camera in a cool, dry, clean location.*
- *When shipping the camera, it's recommended to put it in a plastic bag with desiccant to avoid problems with condensation during temperature changes.*
- *If the camera will be stored for more than a few weeks, charge or discharge the battery to a 40% charge (approximately), then turn off the camera and remove the battery. This will minimize battery capacity degradation during storage.*
- *Before shipping, always enable Shipping Mode, found on the **Util** menu, under the Factory Tab, to avoid the possibility of the camera turning on in-transit. This mode requires the AC adapter to be connected the next time the camera is turned on.*

Annex J – Mechanical Drawing

CHRONOS 1.4 / CHRONOS 2.1-HD

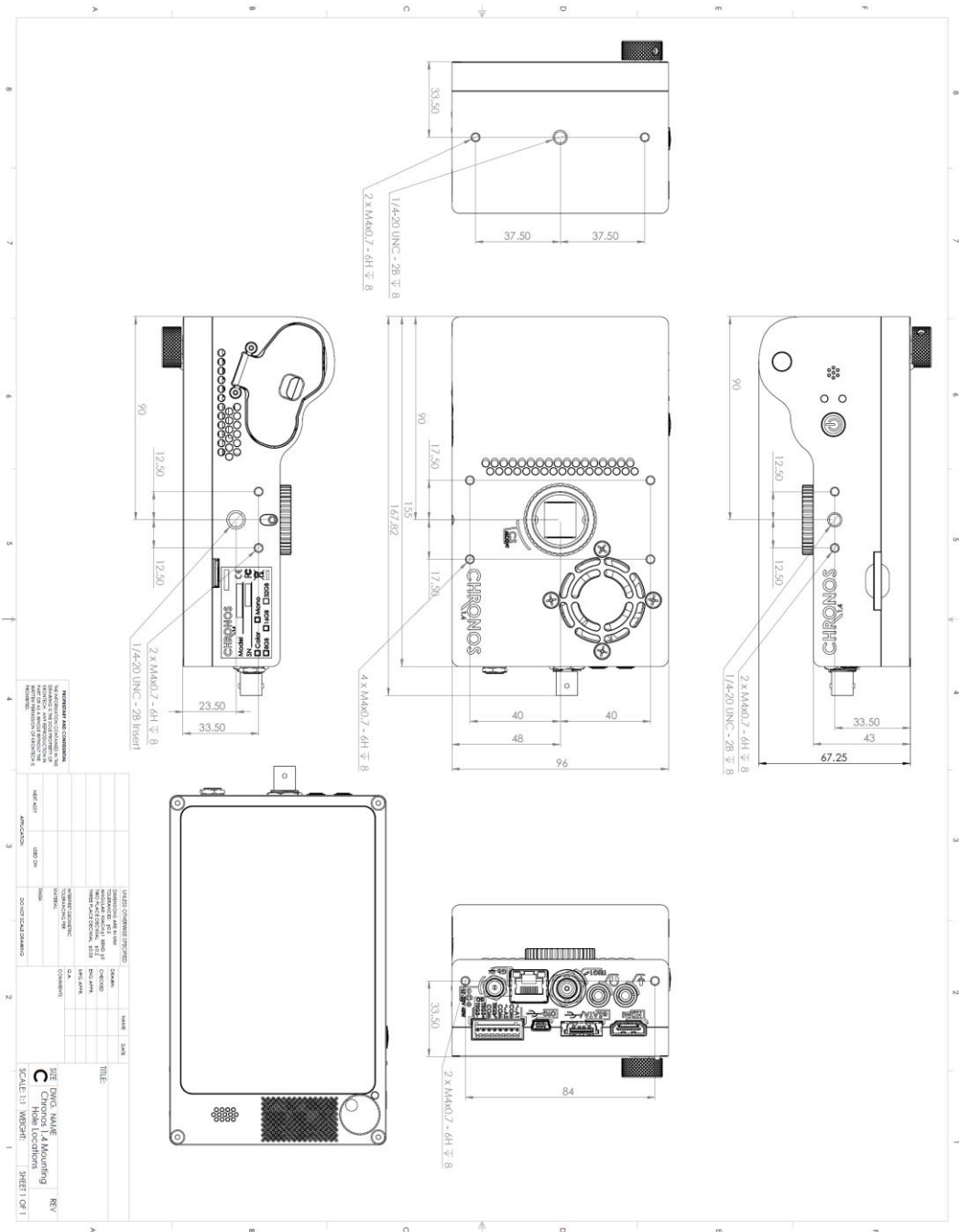

NOTE: The Chronos 1.4 and 2.1-HD have identical enclosure dimensions.

Annex K – Spectral Response

CHRONOS 1.4

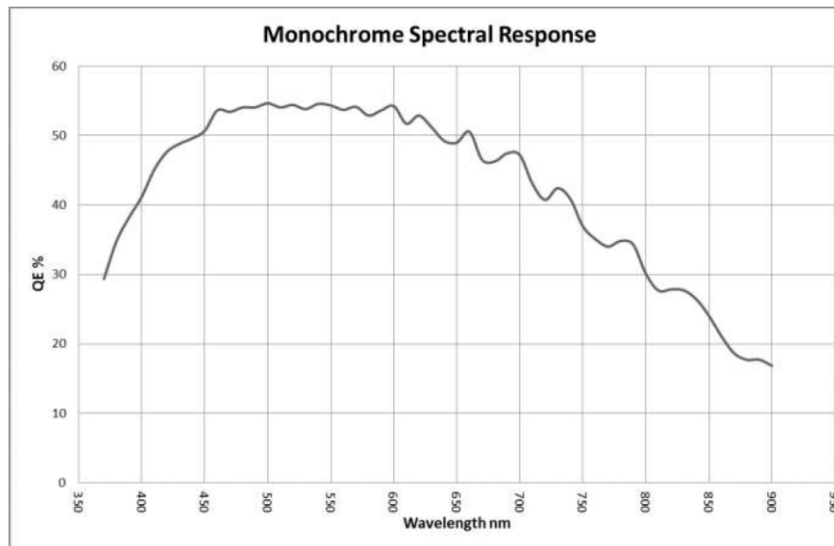
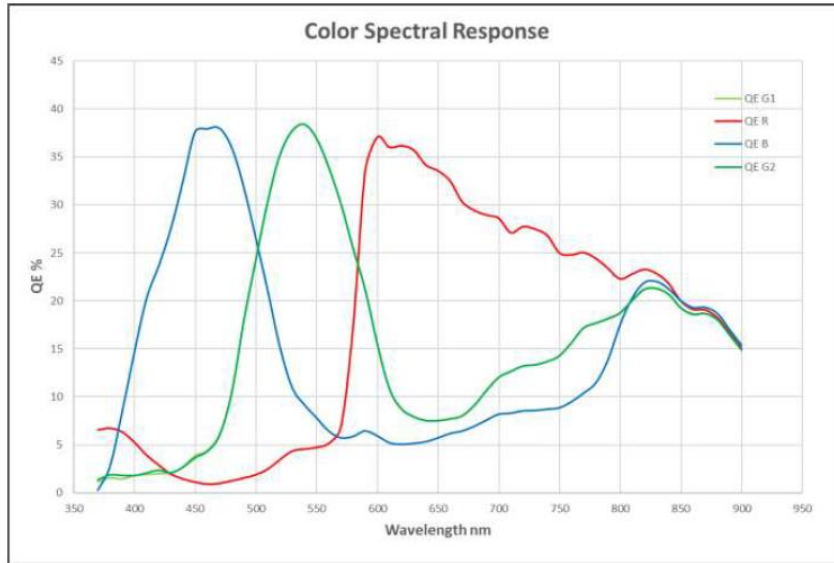

NOTE: *These spectral response curves are in units of quantum efficiency*

CHRONOS 2.1-HD

LUX2100 Color Spectral Response

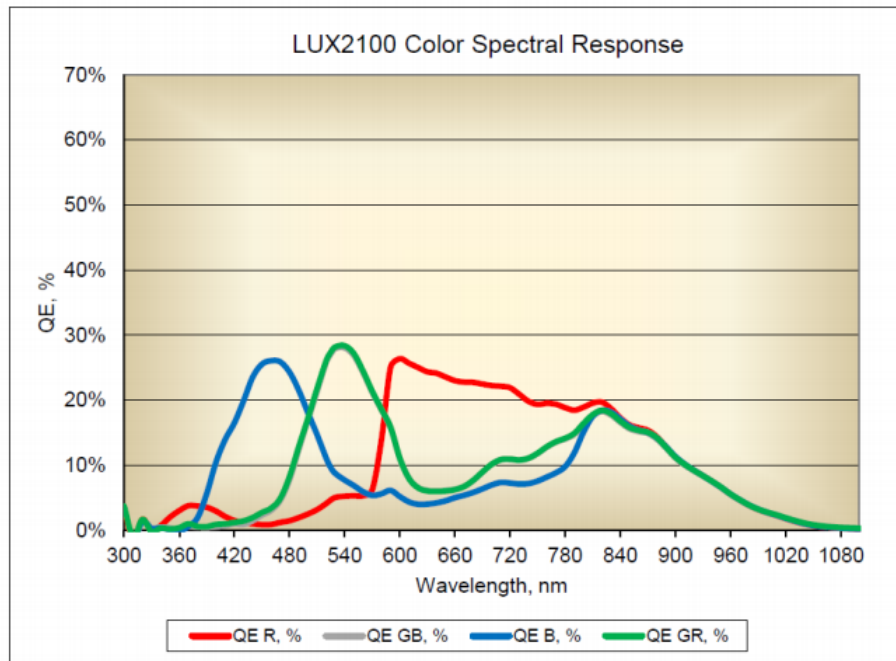

LUX2100 Monochrome Spectral Response

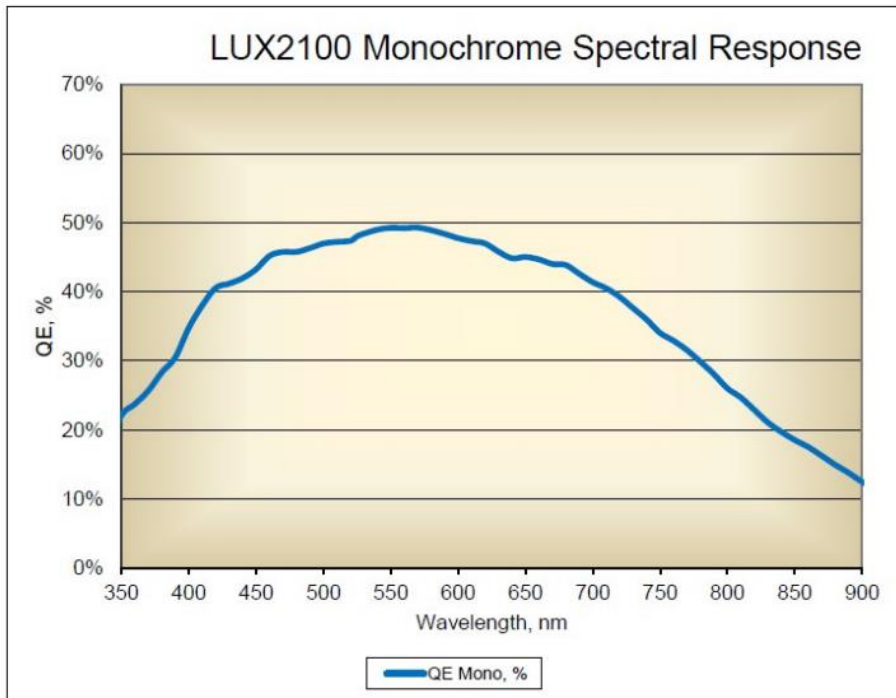

NOTE: These spectral response curves are in units of quantum efficiency

Annex L – Software Functions

This Annex discusses each screen shown on the camera in detail. While the User Interface on the Chronos is designed to be intuitive and to follow common operating modes found in many other cameras, this section provides concise descriptions on the action performed by each button shown on various screens.

MAIN WINDOW

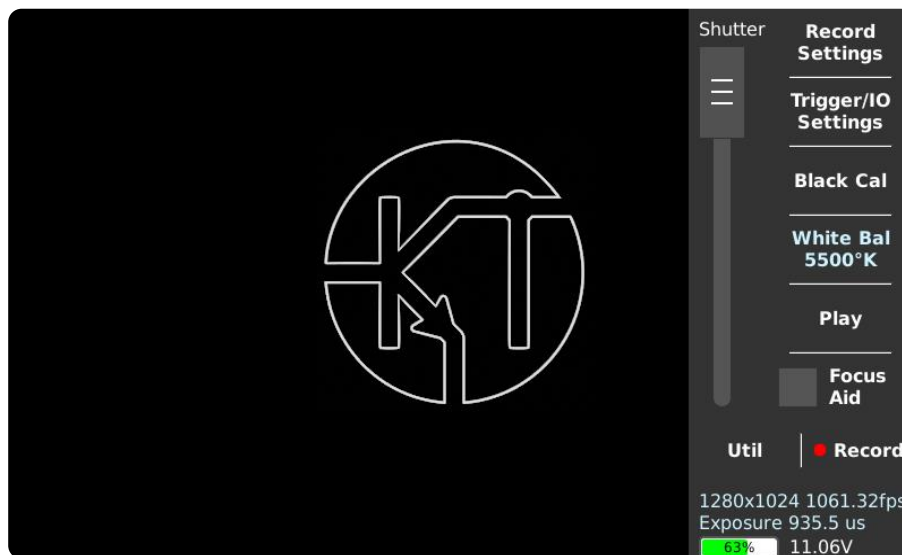

Control	Function
Record Settings	Shows the Record Settings window, which allows adjustment of resolution, frame rate, analog gain (ISO), digital gain, exposure, record modes, and trigger delay.
Trigger I/O Settings	Shows the Trigger Settings window, which allows for the selection of trigger and synchronization input/output (I/O) signals.
Black Cal	Performs a Black Calibration. This increases image quality by removing noise and sensor artifacts due to fluctuations in temperature. Each resolution and gain must be Black Calibrated separately prior to use. The image sensor should not be exposed to light during a calibration.

MAIN WINDOW [CONTINUED]

Control	Function
White Bal (Color Cameras)	Shows the White Balance dialog box, which allows setting the color temperature of the recorded footage.
Focus Aid	Enables or disables focus peaking, which highlights sharp edges in a conspicuous color. This can be used when adjusting focus is challenging. The color and sensitivity are adjustable from the Util menu.
Record/Stop	Starts and stops recording. Performs the same function as the physical shutter button on the top of the camera.
Util	Shows the utility menu, which contains various functions such as storage management, network connection information, power management, display behavior, and software updates.
Shutter	<p>Drag and slide to adjust the image sensor's exposure level. Rotating the jog wheel will also adjust this slider. Pressing the jog wheel in while rotating will cause the shutter to adjust at finer intervals.</p> <p>The exposure readout in the bottom right corner of the display will change accordingly. Units can be changed between temporal, angular, or fractional in the <i>Util</i> menu.</p>
Viewfinder Zoom Mode	Double tap the video output region on the display to zoom by a factor of 2.5x. This can be used as a focusing aid. Double tap the zoomed view again to return to the normal video display mode.

RECORD SETTINGS

The Record Settings screen allows for the adjustment of the size and position of the recorded area on the image sensor, and the frame rate at which the recording is taken. Lower resolutions can be captured at higher frame rates and/or longer record times.

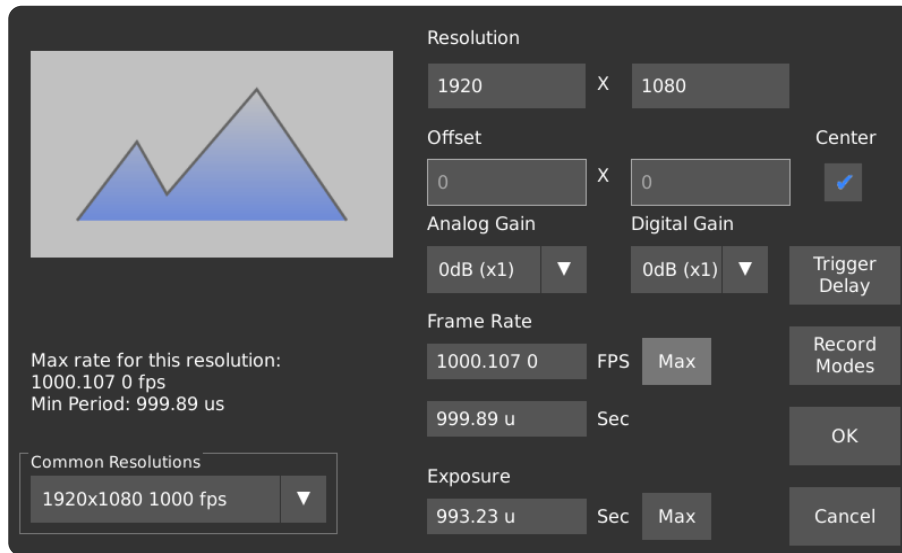

Control	Function
Resolution (width, height)	<p>Sets the recorded video size.</p> <p>Chronos 1.4: Adjustable in multiples of 16 pixels horizontally, 2 pixels vertically.</p> <p>Chronos 2.1-HD: Adjustable in multiples of 32 pixels horizontally, 2 pixels vertically.</p>
Offset (horizontal, vertical)	<p>Adjusts the position of the recorded video relative to the top left corner of the image sensor, in multiples of 16 pixels horizontally for the Chronos 1.4, 32 pixels horizontally for the Chronos 2.1-HD, and 2 pixels vertically.</p> <p>When the <i>Center</i> box is checked, the offset is set automatically and cannot be adjusted.</p>

RECORD SETTINGS [CONTINUED]

Control	Function																																		
Center	Affects the position of the image when using a resolution below maximum resolution. When checked, the offset is calculated automatically to center the image.																																		
Frame Rate	<p>Sets the frame rate. Can be set as framerate (FPS) or period (Seconds) which is equivalent to 1/framerate. Setting one will automatically update the other.</p> <p>Can be set to the maximum for the resolution by pressing <i>Max</i>.</p> <p>To increase the record time and maximum exposure time, manually enter a frame rate lower than the maximum.</p>																																		
Exposure	Sets the exposure (shutter speed) in <i>seconds</i> . Range is 1 μ s to slightly less than 1/framerate. Can be set to the maximum for the current frame period by pressing <i>Max</i> .																																		
Analog Gain	<p>Adjusts the ISO setting. A higher gain results in increased sensitivity (less lighting required), but increased image noise.</p> <p>For the best image quality, use the lowest possible gain, and increase light level or lens aperture if more light is required.</p> <table border="1" data-bbox="467 1283 1403 1570"> <thead> <tr> <th rowspan="2">Gain</th> <th colspan="2">Chronos 1.4</th> <th colspan="2">Chronos 2.1-HD</th> </tr> <tr> <th>Color ISO</th> <th>Mono ISO</th> <th>Color ISO</th> <th>Mono ISO</th> </tr> </thead> <tbody> <tr> <td>0 dB (x1)</td> <td>320</td> <td>740</td> <td>500</td> <td>1000</td> </tr> <tr> <td>6 dB (x2)</td> <td>640</td> <td>1480</td> <td>1000</td> <td>2000</td> </tr> <tr> <td>12 dB (x4)</td> <td>1280</td> <td>2960</td> <td>2000</td> <td>4000</td> </tr> <tr> <td>18 dB (x8)</td> <td>2560</td> <td>5920</td> <td>4000</td> <td>8000</td> </tr> <tr> <td>24 dB (x16)</td> <td>5120</td> <td>11840</td> <td>8000</td> <td>16000</td> </tr> </tbody> </table>	Gain	Chronos 1.4		Chronos 2.1-HD		Color ISO	Mono ISO	Color ISO	Mono ISO	0 dB (x1)	320	740	500	1000	6 dB (x2)	640	1480	1000	2000	12 dB (x4)	1280	2960	2000	4000	18 dB (x8)	2560	5920	4000	8000	24 dB (x16)	5120	11840	8000	16000
Gain	Chronos 1.4		Chronos 2.1-HD																																
	Color ISO	Mono ISO	Color ISO	Mono ISO																															
0 dB (x1)	320	740	500	1000																															
6 dB (x2)	640	1480	1000	2000																															
12 dB (x4)	1280	2960	2000	4000																															
18 dB (x8)	2560	5920	4000	8000																															
24 dB (x16)	5120	11840	8000	16000																															

RECORD SETTINGS [CONTINUED]

Control	Function
Digital Gain	Increases the brightness in the scene by automatically modifying <i>White Balance</i> and <i>Color Matrix</i> settings. As starting points, this function uses CIECAM16/D55 and a color temperature of 3200K (Tungsten). A setting of <i>None</i> will not modify existing settings.
Common Resolutions	Select a pre-set from common picture sizes and frame rates. The frame rate will automatically be set to the maximum for the selected pre-set.
Recorded Area Display	Shows the size and position of the recorded area in relation to the sensor's full resolution. The outer box represents the sensor's maximum resolution, and the inner box represents the area on the image sensor that will be recorded, given the currently selected resolution and offset.
Max Rate Display	Shows the maximum frame rate and minimum period for the current resolution setting.
Trigger Delay Button	Opens a screen to configure the amount of record time before and after a triggered event. Trigger delay only applies to external triggers through the BNC connector, or the Auxiliary I/O connector on the side of the camera, but not the red shutter button on top of the camera.
Record Mode Button	Opens a screen to switch between Normal, Segmented, Gated Burst and Live Slow-Motion modes.
OK Button	Applies changes and closes window.
Cancel Button	Discards changes and closes window.

RECORD MODE – NORMAL

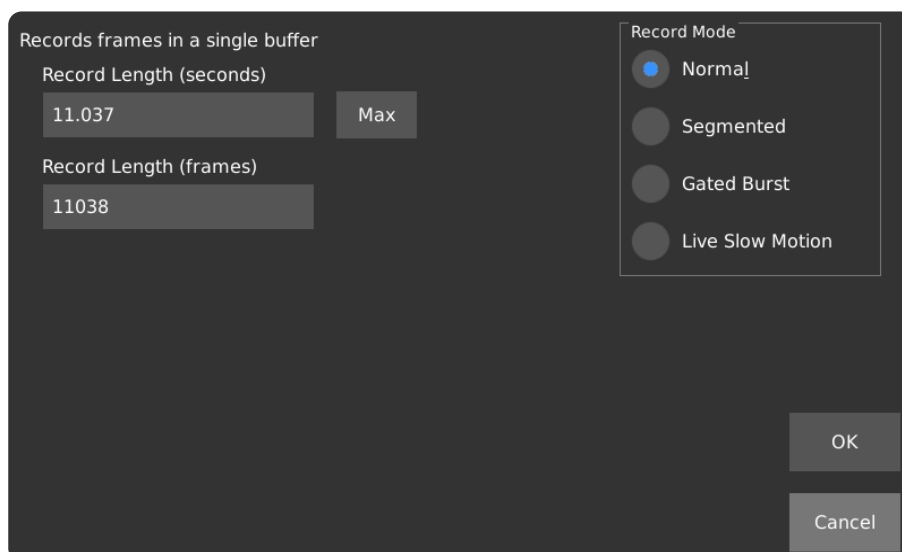

Control	Function
Record Length (Seconds)	Set the duration of the triggered recording, in <i>seconds</i> . The timing of this recording can be changed in the <i>Trigger Delay</i> window.
Record Length (frames)	Set the duration of the triggered recording, in <i>recorded frames</i> . The timing of this recording can be changed in the <i>Trigger Delay</i> window.
Max Button	Sets record length to the maximum available. This is dependent on your camera's memory capacity, as well as the resolution settings, which can be changed in <i>Record Settings</i> .
OK Button	Applies changes and closes window. OK must also be selected in the <i>Record Settings</i> window after the <i>Record Mode</i> window has closed, otherwise the changes will be discarded.
Cancel Button	Discards changes to the Record Mode.

RECORD MODE - SEGMENTED

In Segmented mode, multiple video segments are kept in memory. This is different from Normal mode, in which only one continuous video clip can be kept in memory.

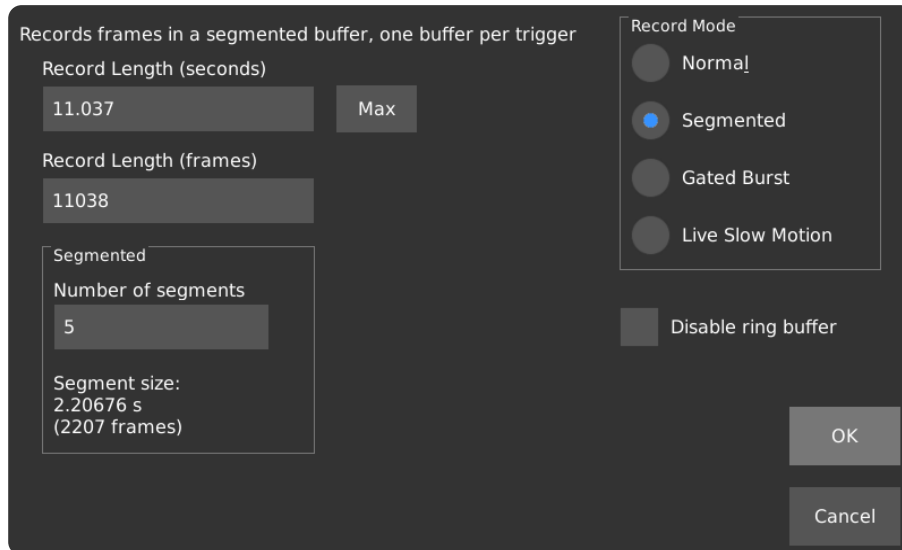

In Segmented mode, when the recording is started, and with each activation of the trigger, a new segment is stored in memory. The segments of video are concatenated during playback and saving. If the desired save format is either H.264 or TIFF, the *Text Overlay* feature can be enabled in *Playback Settings* to label the frames with which segment they belong to.

Segmented Memory Timing Chart

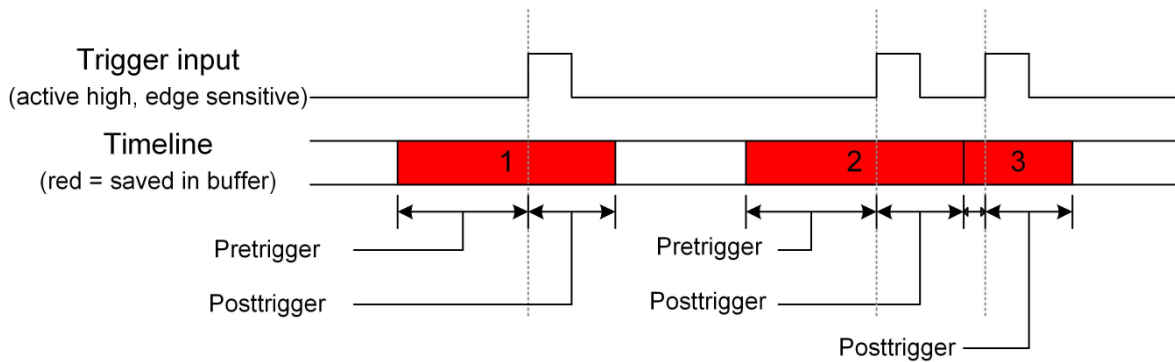

By default, the Ring Buffer is enabled. In this mode, the earliest segment will be overwritten with a new one as soon as the record buffer is full. New segments will be created until the recording is stopped via the red shutter button on the top of the camera, or the stop button on the *Main* screen. This behavior can be changed by checking the *Disable Ring Buffer* option. When the Ring Buffer is disabled, the camera will stop recording when the buffer is full, and segments will not be overwritten.

Control	Function
Record Length (Seconds)	Set the duration of the recorded segment, in <i>seconds</i> . The timing of this recording can be changed in the <i>Trigger Delay</i> window.
Record Length (frames)	Set the duration of the recorded segment, in <i>frames</i> . The timing of this recording can be changed in the <i>Trigger Delay</i> window.
Max Button	Sets record length to the maximum available for your camera model and the selected number of segments.
Number of Segments	The maximum number of full-size segments that can be held in memory is 65,536. Each time a recording is triggered, it is saved into a subsequent region of memory. If a recording is stopped early, the unused recording time is returned for future segments to use. For example, two 0.5-second segments can be recorded instead of one 1-second segment.
Disable Ring Buffer	When the buffer is full of segments, stop recording instead of overwriting the oldest segment with new frames.
OK Button	Applies changes and closes window. OK must also be selected in the <i>Record Settings</i> window after the <i>Record Mode</i> window has closed, otherwise the changes will be discarded.
Cancel Button	Discards changes to the Record Mode.

NOTE: In Segmented Mode, new recordings can only be started using either the shutter button on top of the camera, or the *Record* button on the main screen. New segments are only started when a trigger signal configured as a *Record End Trigger* is active.

RECORD MODE – GATED BURST

In Gated Burst mode, multiple videos are kept in memory. New video is recorded only while the trigger input is active. Record mode only affects which frames are stored in memory; it does not affect exposure time.

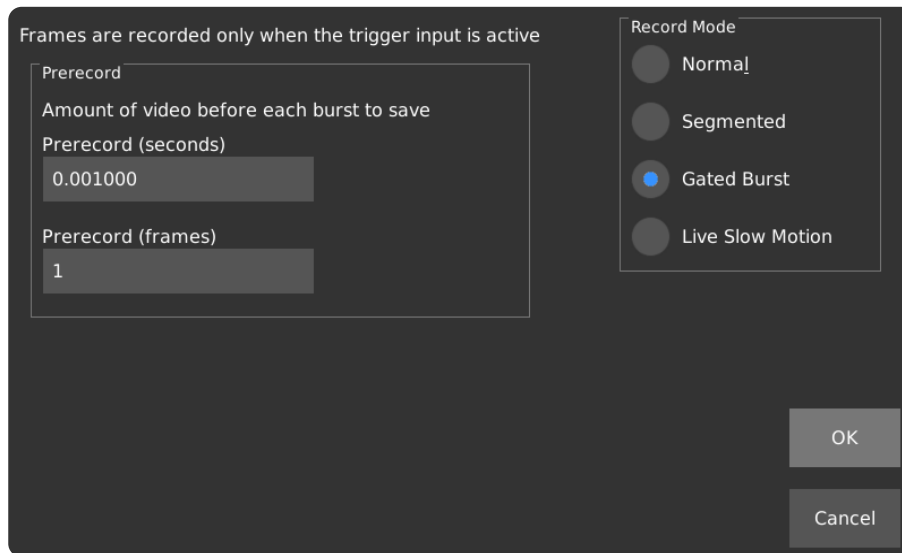

Gated Burst Memory Timing Chart

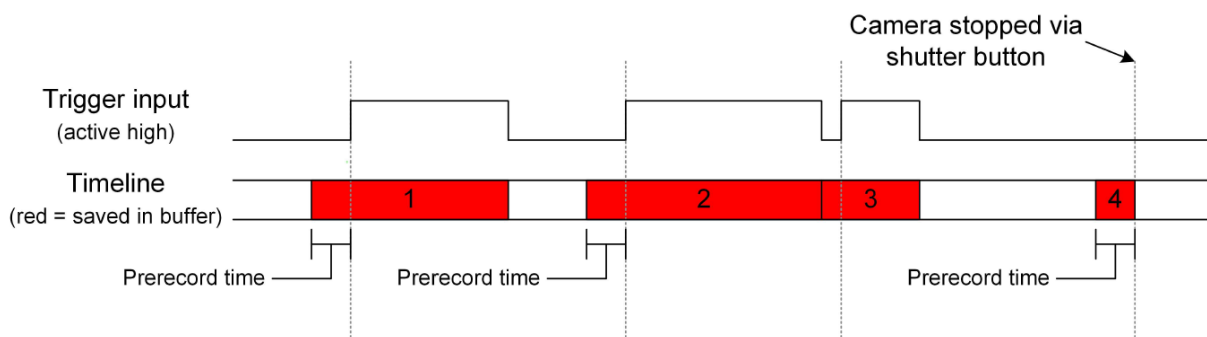

As frames are recorded, they are stored in the Ring Buffer. The oldest frames are overwritten with new frames as the trigger continues to be active. Recorded frames are concatenated during playback and saving.

RECORD MODE – GATED BURST [CONTINUED]

Control	Function
Prerecord (seconds)	Sets the amount of video to save before the trigger becomes active, in <i>seconds</i> .
Prerecord (frames)	Sets the amount of video to save before the trigger becomes active, in <i>recorded frames</i> .
OK Button	Applies changes and closes window. OK must also be selected in the <i>Record Settings</i> window after the <i>Record Mode</i> window has closed, otherwise the changes will be discarded.
Cancel Button	Discards changes to the Record Mode.

RECORD MODE – LIVE SLOW MOTION

In Live Slow Motion mode, a short segment of video is recorded, and then played back in a loop. The interface allows you to set the desired loop time, and the choice of playback rate can be either 15, 30, or 60 FPS. The length of the recorded segment is calculated based on the loop length and the recording frame rate and is displayed on the screen.

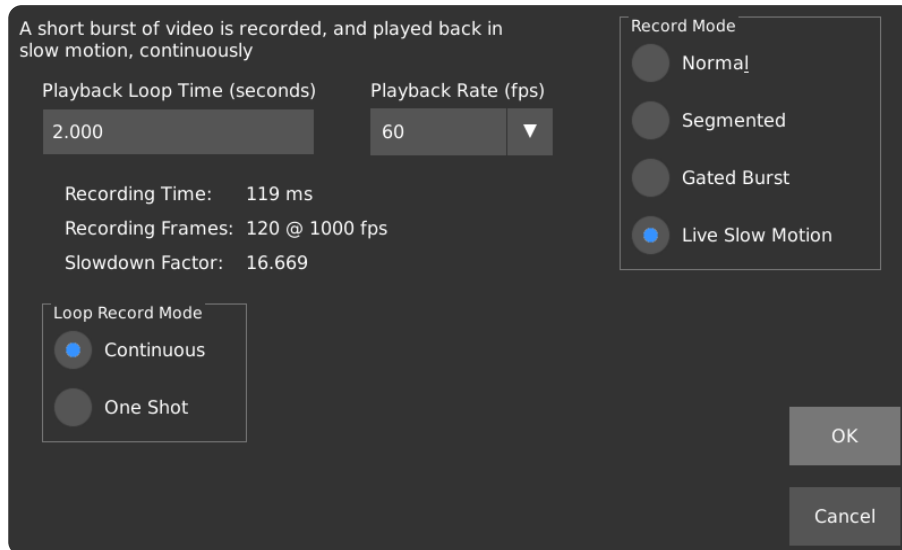

Control	Function
Playback Loop Time (seconds)	Sets the desired playback length of the loop, in <i>seconds</i> .
Recording Time	Displays the recording time, calculated from the loop length and the frame rate setting, in <i>milliseconds</i> .
Recording Frames	Displays the number of frames to be recorded, calculated from the loop length and the frame rate setting, in <i>frames</i> .
Slowdown Factor	Displays the factor by which the loop playback will be slowed down, using the current settings, as a <i>ratio</i> .

RECORD MODE – LIVE SLOW MOTION [CONTINUED]

Control	Function
Playback Rate (FPS)	Set the desired playback frame rate. This setting affects the recording time, recording frames, and slowdown factor, even when the recording frame rate is not changed. The options are 15, 30, and 60 frames per second.
Continuous	When this Loop Recording Mode is selected, a short segment is recorded and played back immediately for the duration specified. This method of capture and playback is repeated continuously.
One Shot	When this Loop Recording Mode is selected, the camera records a short segment only once, and then plays back the same segment continuously without acquiring new footage.
OK Button	Applies changes and closes window. OK must also be selected in the <i>Record Settings</i> window after the <i>Record Mode</i> window has closed, otherwise the changes will be discarded.
Cancel Button	Discards changes to the Record Mode.

TRIGGER / IO SETTINGS

The Trigger I/O screen allows for the configuration of external inputs, and control over how external inputs affect the recording process. This section describes the function of each selection on the *Trigger I/O* screen. For a detailed dialogue of each triggering mode, please refer to the *Triggering* section in the main manual.

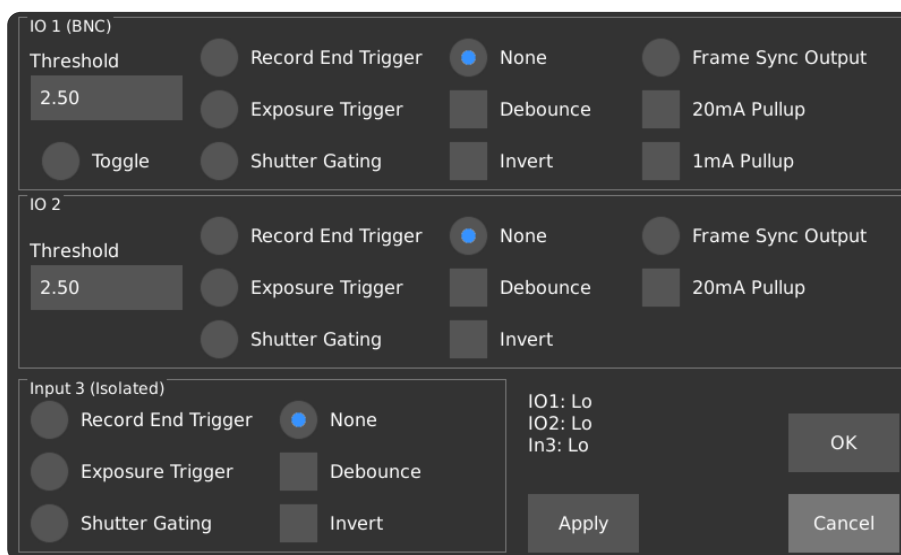

Multiple triggers of the same effect are combined with a *logical OR*. Edge detection, which is used as a record-end trigger, is applied after this operation.

Control	Function
Threshold	<p>Sets the input voltage threshold for the associated IO interface. When the threshold is exceeded, the input will change between high and low.</p> <p>Acceptable voltage thresholds are from 0 V to 6.6 V.</p>
Record End Trigger	<p>Sets function of the IO to trigger input, allowing the associated input to be used to trigger the end of a recording, or to be used with the <i>Segmented</i> or <i>Gated Burst</i> record modes.</p>
Exposure Trigger	<p>Sets function of IO to control the start of exposure for each frame.</p> <p>Normal recording is prevented if this mode is selected without a valid signal.</p>

TRIGGER / IO SETTINGS [CONTINUED]

Control	Function
Shutter Gating	<p>Sets function of IO to control the start and length of exposure for each frame.</p> <p>Normal recording is prevented if this mode is selected without a valid signal.</p>
Frame Sync Output	<p>Sets function of IO to frame sync output. Output will be active when the shutter is open. Can be inverted with by selecting the <i>Invert</i> checkbox.</p>
Pullup	<p>Enables 1mA or 20mA pullup on trigger input. Enabling both will result in a 21mA pullup. There is a 5k-ohm pulldown resistor on the input, which defaults to a low-level.</p> <p>When pullups are enabled, current is driven into the trigger and the logic level rises. The input can be pulled low externally by shorting the BNC connector to ground. Pullups will bring the voltage level to 4-5V, with no load.</p> <p>A tutorial on this subject can be found at https://www.krontech.ca/tutorials/.</p>
None	<p>Disables the associated IO.</p>
Invert (Trigger Input)	<p>When checked, the trigger input will be sensitive to a <i>low</i> logic level, as opposed to a <i>high</i> logic level.</p> <p>Example: The recording would end when the external trigger cable button is pressed, rather than when it is released.</p>
Debounce	<p>Use a 10 millisecond debounce filter on the input. This is recommended when using a physical button or switch as the trigger source to avoid glitches due to mechanical contact bounce.</p>
Input Status	<p>Shows the real-time level of 3 inputs, after optional inversions are applied.</p>
Apply Button	<p>Applies IO settings without closing the window.</p>
OK Button	<p>Applies IO settings and closes the window.</p>
Cancel Button	<p>Discards changes and closes the window.</p>

TRIGGER DELAY

The Trigger Delay page lets the user configure when video is captured relative to an external trigger. The delays configured in this screen do not apply to recordings started by the shutter button on the top or the camera and the record button on the display.

NOTE: If delays are used in conjunction with *Segmented Recording Mode*, the trigger delay affects the time between the trigger and the beginning/end of each segment.

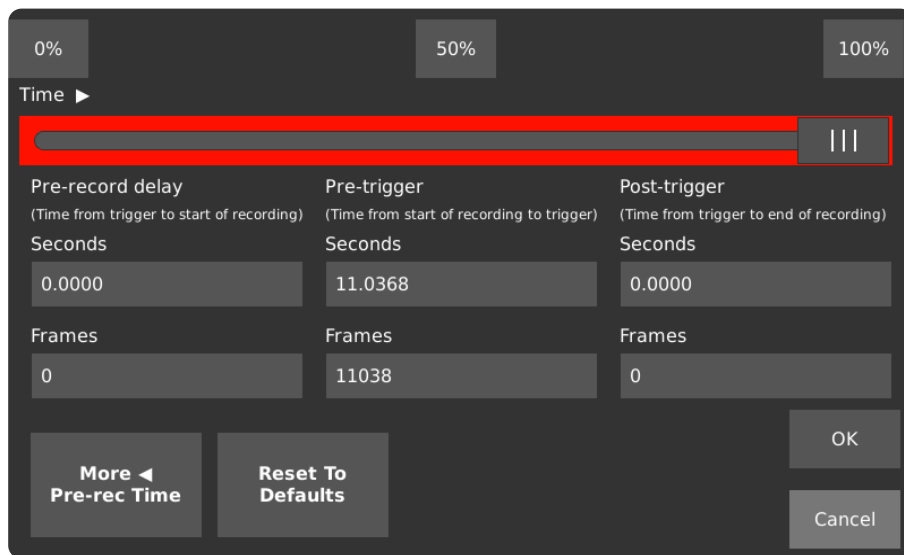

Control	Function
<p>0%, 50%, 100%</p>	<p>Move the slider to the start, middle, or end of the red <i>Recording This</i> region. This sets the pre-record delay, pre-trigger, and post trigger values.</p> <p>A value of 0% means that all video saved will be saved after the trigger (post-trigger mode). A value of 100% means that all video saved will be saved before the trigger (pre-trigger mode).</p>
<p>Slider</p>	<p>Drag to set when the saved video starts and stops relative to a trigger. The time and frames in each text box below will automatically change as the slider is adjusted.</p>

TRIGGER DELAY [CONTINUED]

Control	Function
<p>Pre-Record Delay</p>	<p>Sets the length of time to wait after a trigger occurs. When the waiting period ends, recording will begin.</p> <p>This delay can be specified in seconds or frames.</p> <p>Example: If a 0.5 second recording is being made, and the pre-record delay has been set to 0.2 seconds, the camera will wait for 0.2 seconds after being triggered to start recording, and then stop 0.7 seconds after the trigger was initially activated.</p>
<p>Pre-Trigger</p>	<p>Sets the amount of time to record before a trigger occurs.</p> <p>Example: If a 5000 frame recording is being made, and the pre-trigger is set to 2000 frames, when the trigger occurs the camera will record 2000 frames before the trigger, and 3000 frames after the trigger.</p>
<p>Post-Trigger</p>	<p>Sets the amount of time after a trigger to start recording. If both pre-record delay and pre-trigger are 0, post-trigger is the total length of the recorded video.</p> <p>Example: If a 0.5 second recording is being made, and the post-trigger delay is set to 0.3 seconds, then the pre-trigger delay will be 0.2 seconds.</p>
<p>More Pre-Record Time</p>	<p>Add or increase margin to the left of the record region, represented in red, to set a delay between the trigger and the beginning of the recording.</p>
<p>Reset to Default</p>	<p>Set pre-record delay to 0, post-trigger to 0, and pre-trigger to either the maximum record time for the given Chronos model, or the maximum record length as set in <i>Record Modes</i>.</p>
<p>OK Button</p>	<p>Applies the trigger delay changes and closes the window. Changes will still be applied even if <i>OK</i> is not selected in the <i>Record Settings</i> window.</p>
<p>Cancel Button</p>	<p>Discards the trigger delay changes and closes the window.</p>

BLACK CALIBRATION

Image sensors often exhibit small non-uniformities across pixels due to variances in temperature and electrical signal characteristics. To compensate for these non-uniformities, commonly referred to as *Fixed Pattern Noise*, a *Black Calibration* is performed.

During a *Black Calibration*, the camera automatically collects a black reference image, and then subtracts that reference image from all frames captured subsequently, correcting for pixel variations that occur on the image sensor. Pressing the *Black Calibration* button updates the reference image.

Black Calibration is unique to both resolution and gain. The Chronos will attempt to perform an automatic “quick” black calibration when changing to a resolution that contains no prior black calibration reference frame. For the best image quality when recording, perform a *Black Calibration* as close to the start of filming as possible.

IMPORTANT: The image sensor must not be exposed to light when a Black Calibration is in progress. Many lens apertures do not close the iris completely, so installing the lens cover prior to a Black Calibration is recommended.

WHITE BALANCE

Set White Balance to correct for lighting temperature or tint. White Balance is only applied when saving in the H.264 and TIFF formats.

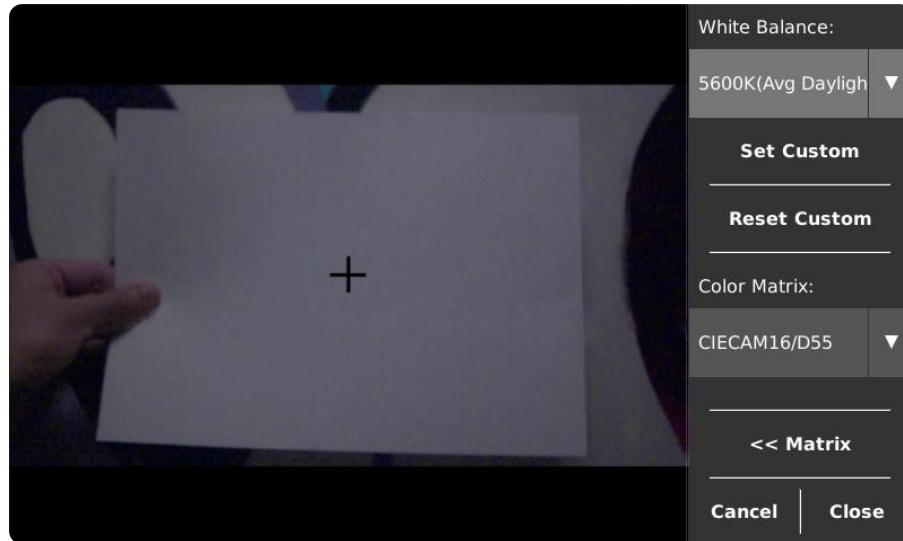

To use a pre-set White Balance, open the drop-down list in the top right of the screen and select the pre-set closest to your current lighting conditions. The numerical component (5600K pictured above) is the color temperature in which a white object will appear white. A description of when light of this color is usually encountered follows the number (“Avg Daylight” as pictured above).

To auto-set a custom White Balance based on a reference white (ideally an 80% gray card), close the Custom Color Matrix window, aim the camera so the crosshair is over the reference, and tap the Set Custom button. To manually set a custom White Balance, use the Custom Color Matrix window.

WHITE BALANCE [CONTINUED]

Control	Function
White Balance	Choose from pre-set and custom White Balances.
Set Custom White Balance	<p>Sets custom White Balance based on white reference.</p> <p>If the <i>Custom Color Matrix</i> window is open, the White Balance will be set according to manually entered values.</p> <p>White Balance values derived from either of the above methods will be stored as <i>Custom</i> in the drop-down menu.</p>
Reset Custom White Balance	Resets the custom White Balance to the value to the value it had when the White Balance dialog box was opened.
Color Matrix	<p>Displays the color matrix that is being applied. This can either be CIECAM16/D55, CIECAM02/D55, or Custom if using the <i>Custom Color Matrix</i>.</p> <p>The White Balance pre-sets will produce the most correct colors under a D55 illuminant.</p> <p>For more information regarding standard illuminants, visit: https://en.wikipedia.org/wiki/Standard_illuminant</p>
Matrix	Opens and closes the <i>Custom Color Matrix</i> Window.
Close Button	Closes the White Balance dialog box.

CUSTOM COLOR MATRIX WINDOW

This window allows manual editing of the values used to process colors. These values are applied only when saving in the H.264 and TIFF formats.

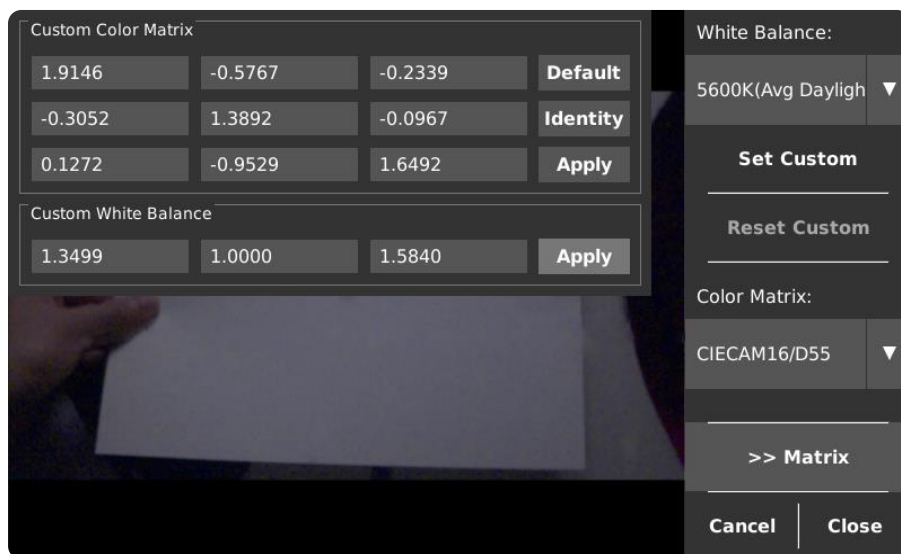

Control	Function
Custom Color Matrix	These 9 values are used in the process of converting between color spaces. Edits to them will be visible on the image immediately but will be reset unless the <i>Apply</i> button is pressed before closing the window.
Default	Resets color matrix values back to default (CIECAM16/D55).
Apply	Stores either the Color Matrix or Custom White Balance values so they will be applied after a reboot, and on subsequent uses of the <i>Custom</i> setting for the Color Matrix or White Balance.
Custom White Balance	These 3 values are used to counteract slight variations in color temperature and tint. Stores the Custom White Balance values so they will be applied each time the <i>Custom</i> pre-set is selected as the White Balance, and on reboots.

PLAY

The Playback mode allows review, trimming, and saving of recorded frames. The image on the left displays the frames that have been recorded.

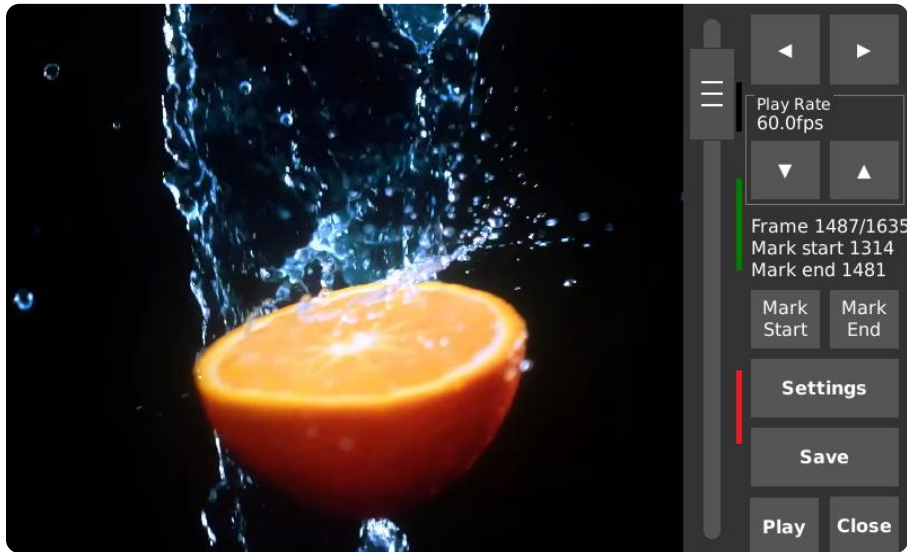

The colored bar to the right of the slider indicates the region to be saved. When saving more than one region, the colored bars will change colors to denote the regions that have previously been saved.

IMPORTANT: After saving the desired footage, always unmount the storage device properly by going into Settings, then tapping **Safely Remove**. Similar to a PC, this tells the camera's operating system to flush any remaining data from internal memory to external storage.

PLAY [CONTINUED]

Control	Function
Playback Slider	The scroll bar controls the playback position over the entire recording. The bottom is the beginning of the buffer, while the top is the end.
Jog Wheel (Physical Dial)	Rotate to control current frame position. Turning the wheel clockwise will advance playback by one frame per detent. Pushing the wheel in while turning will advance playback by 40 frames per detent.
Forward/Back Arrows	Advances the frame position forwards or backwards.
Play Rate Forward/Back Arrows	Increases or decreases playback rate when play button or forward/back arrows are pressed. Range: 10 to 1920 fps. This setting only affects the preview. To set the playback rate for saving, use the <i>Settings</i> button in the Play screen.
Frame/Mark Indicators	Show the current frame, number of frames recorded, and the current Mark Set and Mark End frame positions.
Mark Start/End Buttons	Set the Save Start or Save End position to the currently displayed frame. Only the marked region will be saved.
Settings Button	Opens the Save Settings pop-up. This is where the frame rate, save format and text overlay are set.
Play Button	If <i>One-touch Playback</i> is enabled in the <i>Util</i> menu, the Play button automatically advances frames without the need to hold down the forward arrow.
Save Button	Starts saving the marked region of video.
Close Button	Returns to live video mode. This does not erase the recording; it will remain in memory until a new recording is started, a Black Calibration is performed, the resolution is changed, or the video is otherwise cleared.

SAVE SETTINGS

The Save Settings pop-up allows for the configuration of the file before it is written to the external storage device. By default, frames are encoded as H.264 MPEG-4 files and saved to the last storage device that was attached to the camera. *Bits per pixel*, *Saved File Framerate* and *Max Bitrate* are only used when saving as H.264.

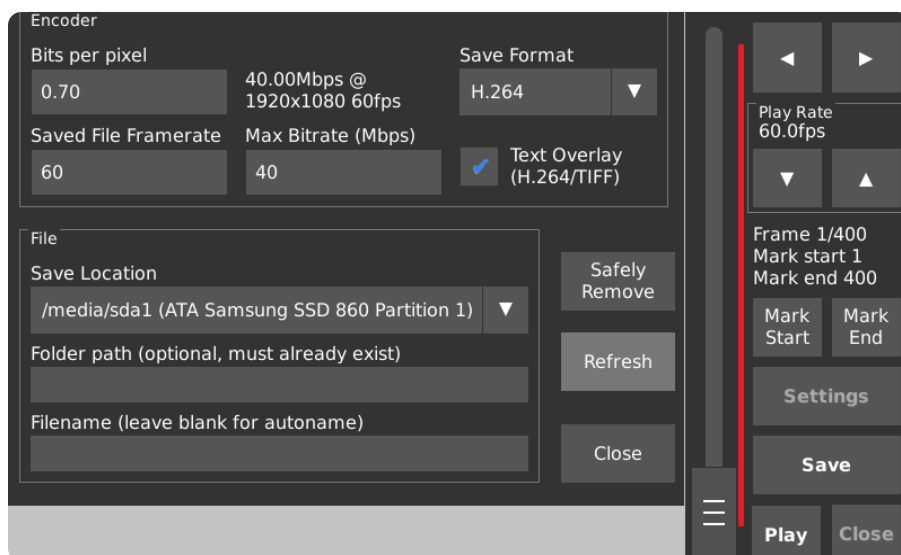

Control	Function
Bits Per Pixel	Primary quality control for H.264 (MPEG-4) encoded saved video. Defaults to 0.70 Bits per pixel.
Max Bitrate	Sets a limit to the playback data rate in megabits per second. [H.264 only] Defaults to 40 Mbps.
__._ Mbps @ _x_ _fps	Shows the bitrate and framerate calculated from the <i>Bits per pixel</i> setting and frame resolution.
Saved File Frame Rate	Sets the playback framerate for saved video files. Defaults to 60 frames per second.

SAVE SETTINGS [CONTINUED]

Control	Function
Text Overlay (H.264/TIFF)	When enabled, the timestamp overlay will be shown on top of the image in Playback mode, videos saved as H.264 MPEG-4, and images saved as TIFF. Information about each frame's position within the recording will be overlaid across the bottom left corner of each frame of encoded video or TIFF image.
Save Location	Selects the storage device for saved video. The list automatically refreshes and switches to the most recently attached device. Please note that it may take several seconds for a newly connected storage device to appear in the list.
Folder Path	Specifying a <i>Folder Path</i> will make the camera save the video into that folder once Save is pressed. If saving in DNG, TIFF, or TIFF RAW, an image for each frame will be saved into a sub-folder within the folder specified.
Filename	Sets the filename for saved video on the device selected in <i>Save Location</i> . If this field is left blank, the files will be named <i>vid_YYYY-MM-DD_HH-MM-SS.mp4</i> according to the current date and time.
Safely Remove	Finish any outstanding writes to selected storage device. When this has completed, the storage device can be unplugged from the camera without the risk of lost data. This action is similar to the <i>Eject</i> or <i>Safely Remove</i> action on a PC.
Close Button	Closes the Save Settings dialog. Settings are applied automatically upon being set.

NOTE: In the rare event that a save operation is unsuccessful and it is critical to recover high-speed footage that was captured, an internal tool can be used to attempt the recovery and saving of frames in the CinemaDNG format. DO NOT power off the camera if a recovery attempt is to be made, as rebooting the camera will clear the acquisition memory in which the last capture of high-speed footage resides. Please contact support@krontech.ca for more information.

COMPARISON OF SAVE FORMATS

Save Format	Usage Notes	Details
H.264	<p>H.264 is the fastest and easiest way to save videos that can then be watched on a wide variety of devices.</p> <p>This format results in MPEG-4 (.mp4) video, which will sacrifice small amounts of quality for compression. Parameters related to compression can be changed in the <i>Encoder</i> section of Play Settings.</p>	<ul style="list-style-type: none"> • Text overlays are possible • Bitrates up to 60 Mbps • Video saved as single file
Raw 12 bit Raw 16 bit	<p>Raw12 is the fastest way to get raw video off the camera since it produces files 75% the size of Raw 16 bit.</p> <p>Raw16 has been kept for legacy support purposes.</p>	<ul style="list-style-type: none"> • DNG images can be extracted from the raw file using an external tool, such as our <i>pyraw2dng</i> python script found here: https://github.com/krontech/chronos-utils/
CinemaDNG	<p>CinemaDNG has the best image quality and compatibility with video editing software.</p>	<ul style="list-style-type: none"> • Individual frames saved in one folder
TIFF	<p>TIFF is compatible with a wide variety of software and can be opened on PCs without the need for extra software.</p> <p>On monochrome cameras, TIFF is generally preferred over CinemaDNG.</p> <p>On color cameras, image quality is slightly lower than CinemaDNG because built-in demosaic and color corrections are performed as oppose to advanced corrections that can be made on modern editing software.</p>	<ul style="list-style-type: none"> • Text overlays are possible • Individual frames saved in one folder
TIFF Raw	<p>TIFF Raw is primarily for scientific use, since brightness is linear-encoded, instead of gamma-encoded.</p>	<ul style="list-style-type: none"> • No on-camera demosaic • Individual frames saved in one folder

UTILITIES SCREEN - MAIN

The *Utilities* page, referred to in short as *Util*, contains general settings and information about the camera.

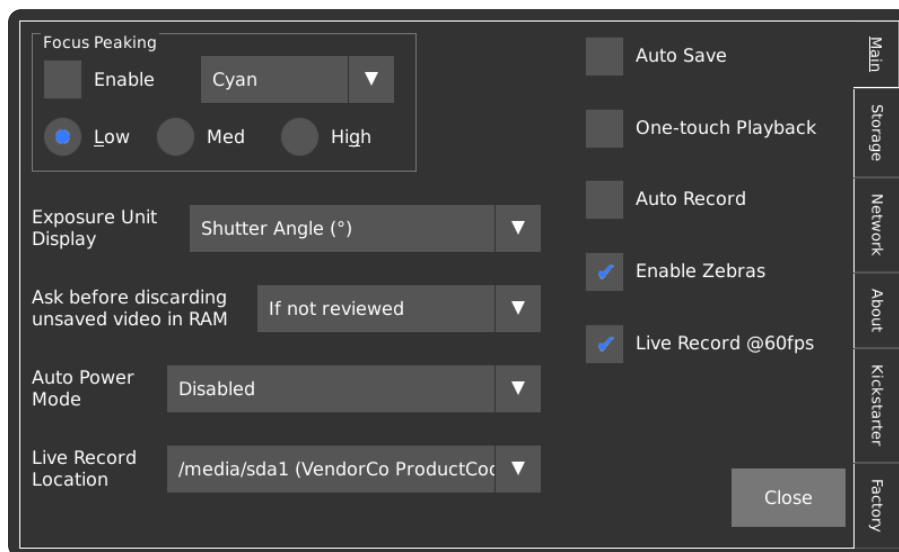

Control	Function
Focus Peaking Enable	Enables <i>Focus Peaking</i> , which highlights objects that are in-focus with the color shown in the dropdown box to the right. This feature can also be enabled or disabled via the <i>Focus Aid</i> checkbox on the main screen.
Focus Peaking Color	Selects the color used to highlight edges that are in focus when <i>Focus Peaking</i> is enabled.
Focus Peaking Sensitivity	Select either <i>Low</i> , <i>Med</i> , or <i>High</i> to configure the sensitivity of the <i>Focus Peaking</i> feature. Increased sensitivity will lead to more noise in the detection result but is ideal for dark edges. Reduced sensitivity will allow for more accurate focusing on bright edges.
Exposure Unit Display	Sets the units in which <i>Exposure</i> is displayed on the main screen. This can either be Fractional Time (μ s), Shutter Angle ($^{\circ}$), or Percentage (%).

UTILITIES SCREEN – MAIN [CONTINUED]

Control	Function
<p>Ask Before Discarding Unsaved Video in RAM</p>	<p>Select for warnings about overwriting video stored in memory. When the Record button is pressed, the warning manifests as a pop-up titled 'Unsaved Video in RAM'. Selecting OK continues while Cancel prevents new video from being recorded so that the previous recording can be saved via the Play screen.</p> <p>One of three options can be set:</p> <p><i>Always</i>: Prompts before starting a recording.</p> <p><i>If Not Reviewed</i>: Prompts when a new recording is started, but only when the previous recording was not opened in the Play screen.</p> <p><i>Never</i>: Disables the prompt entirely.</p>
<p>Auto Power Mode</p>	<p>Useful in cases where the camera's power button is in a location that is not easily accessible during filming, this feature can configure the power management system in the camera to power on when AC power is applied, power off when AC power is removed, or both.</p> <p>Please note: If the power button is pressed to turn the camera off while the <i>Turn on if AC inserted</i> option is enabled, the camera will reboot instead of shutting down.</p>
<p>Auto Save</p>	<p>When a recording ends, the camera automatically saves the entire recording to an external storage device. If <i>Auto Record</i> is selected as well, the camera will record and save in a continuous loop, which can be interrupted by tapping any of the Main screen buttons (except for <i>Focus Aid</i> or <i>Record</i>) and then choosing to stop the recording.</p> <p>Prior to enabling Auto Save, set a save location manually in Save Settings. It is not necessary to set a filename, as videos will be named automatically with the date and time upon saving.</p>
<p>One-touch Playback</p>	<p>Enables a <i>Play</i> button in the bottom-right corner of the Play screen which will play through the marked region without the need to press and hold the frame forward or frame backward button.</p>
<p>Auto Record</p>	<p>Automatically starts a recording after the camera has booted and as long as it is not currently saving video to an external storage device.</p>

UTILITIES SCREEN – MAIN [CONTINUED]

Control	Function
Enable Zebras	Enables the over-exposure indicator, which shows a rolling pattern of black lines (referred to as “Zebra stripes”) over over-exposed areas of the image.
Live Record @60fps	<p>Records the footage as seen on the viewfinder to an external storage device as specified by <i>Live Record Location</i> in parallel with the current high-speed recording. In this mode, an external storage device must be connected prior to recording, or else a warning message will be displayed, and only high-speed footage will be recorded.</p> <p>Audio is also recorded in this mode. The Chronos will automatically switch between the built-in microphone and the line input jack if a line input is detected.</p> <p>The resulting file is an MPEG-4 video with bitrates up to 6 Mbps and audio sampled at 48 kHz. The maximum file size per clip is 4 GB. Please note that some audio drift may occur with recordings that exceed 15 seconds.</p>
Live Record Location	<p>Selects the storage device for saved video at 60 FPS. The list automatically refreshes and switches to the most recently attached device. Please note that it may take several seconds for a newly connected storage device to appear in the list.</p> <p>Videos saved using the <i>Live Record</i> mode will be named <i>live_YYYY-MM-DD_HH-MM-SS.mp4</i>.</p>
Close Button	Returns to the Main window. Settings are applied automatically as they are changed.

STORAGE TAB

The *Storage* page allows for interactions with storage devices that are attached to the camera. This page is also used to backup and restore camera settings and calibration files, as well as to search for software updates over the internet.

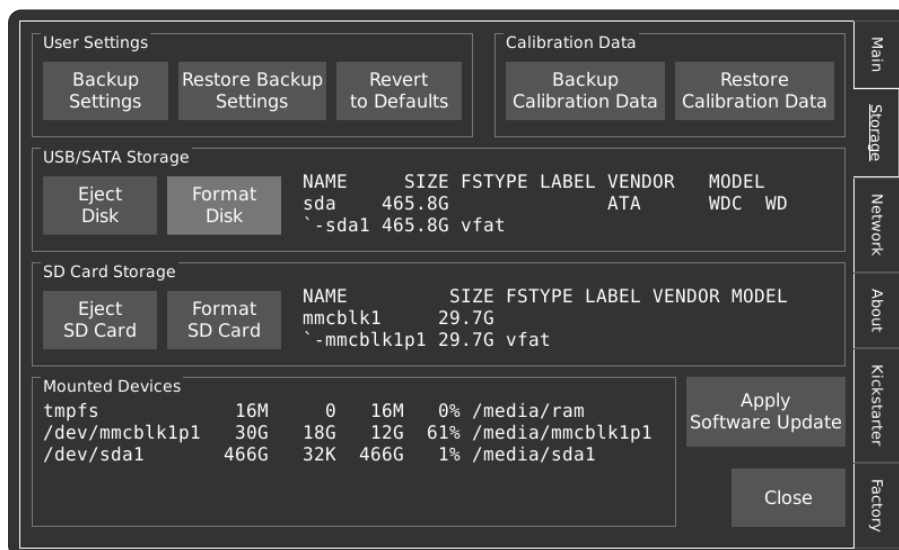

Control	Function
Backup Settings	<p>Backs up the user's configuration preferences, such as resolution, focus peaking, and triggering settings to a USB flash drive.</p> <p>It is recommended that a backup of your camera's configuration be taken prior to each software update, or prior to replacing the system's microSD card.</p>
Restore Backup Settings	<p>Restore saved settings from a USB flash drive.</p>
Revert to Defaults	<p>Set the camera's settings back to the factory default.</p>
Backup Calibration Data	<p>Saves the camera's factory calibration data to a USB flash drive. It is recommended that the user keep a copy if the system's microSD card must be replaced. This excludes black calibration data that was generated by the user, which can be restored by performing a black calibration prior to recording at the desired resolution and analog gain. The file is named <i>cal_<serial number>.tar</i>.</p>

STORAGE TAB [CONTINUED]

Control	Function
Restore Calibration Data	Restore saved settings from a USB flash drive.
Eject Disk/ SD Card	Finish any outstanding writes to the selected storage device and unmount the filesystem from the camera's control. This is equivalent to the "Safely Remove" option on PCs and protects against the loss of unwritten data.
Format Disk/ SD Card	Formats the selected storage device with a FAT32 filesystem, which can be used for saving video.
Apply Software Update	Starts the software update utility, which will use the internet to search for any applicable updates.

SOFTWARE UPDATES

Selecting the *Apply Software Update* button from the *Storage* tab in the *Util* screen will start an update utility that provides a way to search for and install software updates. This screen also allows the User Interface of the camera to be switched between normal use and headless mode.

Control	Function
Update From Local Media	If update files exist on an external storage device, this option allows for the installation of the updates.
Update From Package Repository	This dropdown list contains a list of the package repositories that the camera can search for updates. <i>Voyager</i> is a codename by Kron Technologies that specifies software packages that are tested and stable.
Check for Updates	Attempts to connect to the package repository via an internet connection to search for new updates. The update procedure is discussed in the subsequent pages of this section.
User Interface	This dropdown list allows for the selection of the Graphical User Interface (GUI) that will be displayed on the back of the camera. Selecting <i>headless</i> mode will disable the Graphical User Interface on the subsequent boot, and a blank screen will be shown, but the camera will remain fully functional. This is to accommodate cases where the camera is to be installed in an area where remote control is configured, and user interaction is not desired.

SOFTWARE UPDATES [CONTINUED]

Control	Function
User Interface (Continued)	<p>A recovery mode is built-in to the camera in the case that a software update has failed, or the user wishes to exit headless mode and restore the factory user interface.</p> <p>To enter recovery mode:</p> <ol style="list-style-type: none">1. Shut the camera down.2. Press-in and hold both the shutter button and the rotary encoder wheel.3. Boot the camera by pressing the power button.4. Release the shutter button and rotary encoder wheel once the <i>Chronos</i> logo is shown.5. The <i>Software Updates</i> screen will be shown after a few seconds.
Apply	Applies the selected User Interface.
List Packages	Opens a list of Debian Linux software packages that are currently installed on the camera, along with a description of the function of each package.
Reboot	Causes a soft reboot of the camera.
Quit	Exits the Software Update tool and reloads the camera's user interface and video system.

NOTE: Kron Technologies provides source code for many of the camera's software components, which can be found at <https://github.com/krontech>.

SOFTWARE UPDATES [CONTINUED]

The following section provides a step-by-step demonstration of the camera's online software update procedure. Prior to starting this procedure, please ensure that the camera is connected to the internet via the ethernet port. Network status can be found by navigating to the *Network* tab in the *Util* screen.

WARNING: Always back up configuration and calibration data prior to a software update.

Ensure the camera is either connected to AC power or ensure that the battery is charged over 25%. DO NOT power off the camera while an update is in progress.

In the case that an update is also applied to the camera's power manager, the fan will run at full speed and the status LED will blink green and red until this is complete.

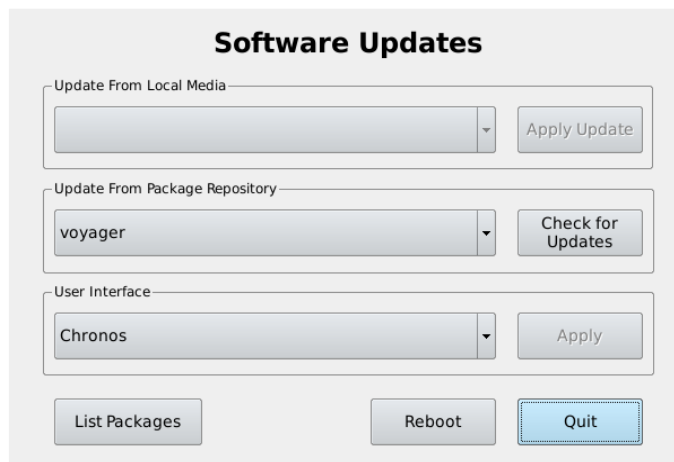

Step 1. Tap the **Check for Updates** button.

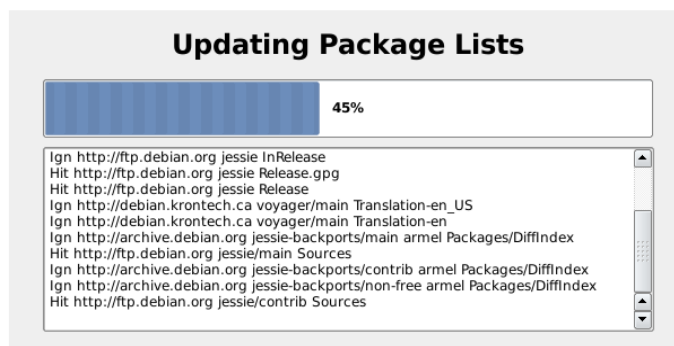

Step 2. The camera will attempt to search package lists for applicable updates.

SOFTWARE UPDATES [CONTINUED]

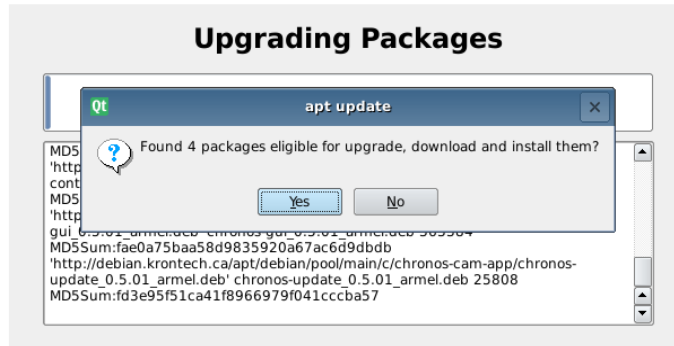

Step 3. If packages are eligible for upgrade, select **Yes** to continue.

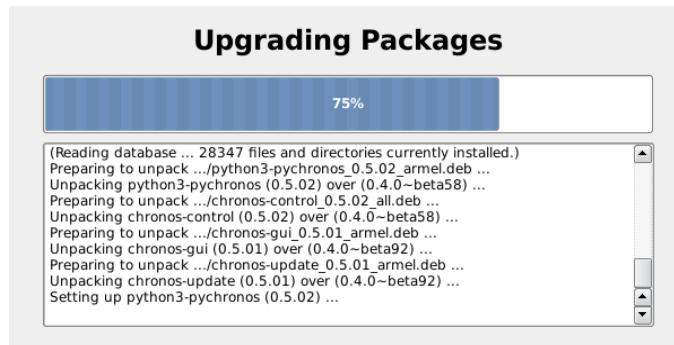

Step 4. The camera will begin to install new packages.

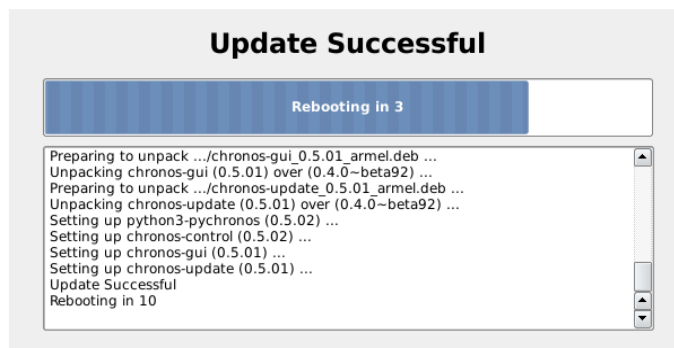

Step 5. If the update is successful, the camera will automatically reboot.

NETWORK TAB

The network interface on the Chronos camera can serve as a powerful and flexible way to use the camera. Over the network, the camera can be controlled via its webpage, footage can be saved via Server Message Block (SMB) and Network File System (NFS) mounts, and a Real Time Streaming Protocol (RTSP) feed of the live output can be viewed.

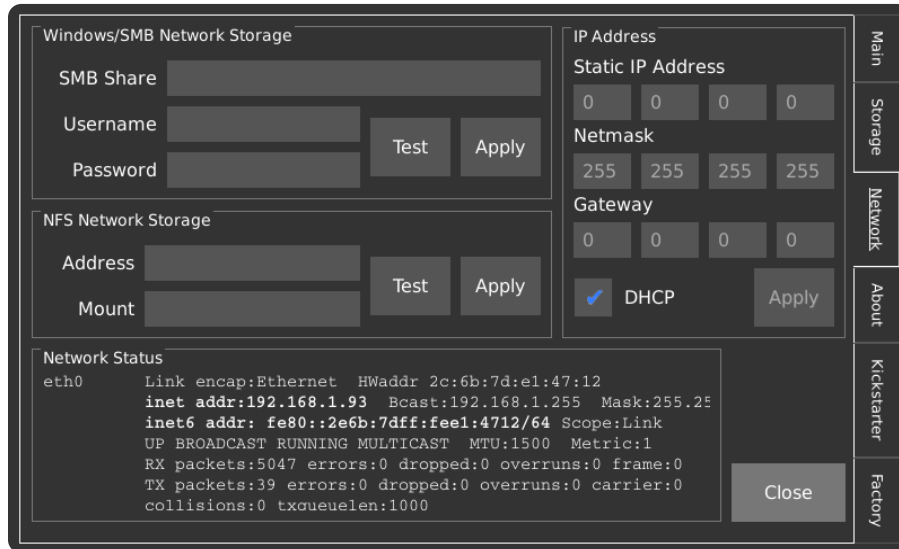

Please refer to the *Networking* and *Web Control* sections of the main manual for detailed guidelines on how to operate these features.

In advanced use cases where the user wishes to adapt the camera to a specific process, it is possible to log into the command line interface on the camera via SSH. SSH Port 22 is only exposed on the USB network interface by default and can be accessed by connecting to the IP Address *192.168.12.1* with username: *root* and password: *chronos*.

ABOUT TAB

This tab contains information about the camera hardware, software, and current operating conditions. In the event that support from Kron Technologies is required, it is useful to provide a photo of this screen along with the rest of the inquiry if possible.

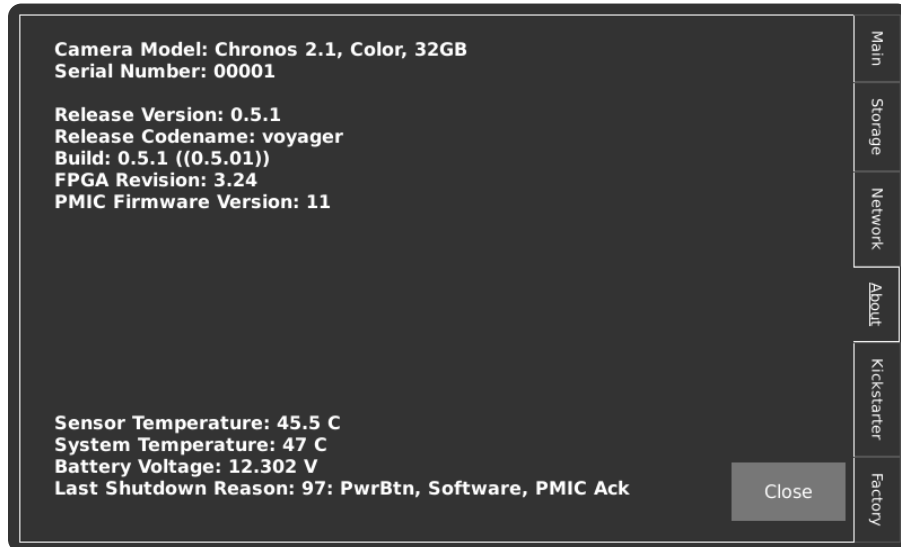

The lower left-hand side of the display shows live information pertaining to the camera's internal systems. The table below describes these parameters in more detail.

Label	Description
Sensor Temperature	The surface temperature of the image sensor inside the camera. Typical values at room temperature are between 40 and 55 degrees Celsius.
System Temperature	The internal temperature at a more central point inside the camera. This value typically equalizes close to that of the <i>Sensor Temperature</i> .
Battery Voltage	The current battery voltage. This value depends on the condition of the battery and the charge and can be helpful in determining whether a battery can no longer function properly.
Last Shutdown Reason	The reason for the last shutdown that had occurred. Each tag separated by a comma signifies a stage in the shutdown sequence that was acknowledged.

FACTORY TAB

This tab contains functionality related to the manufacturing and factory calibration of the camera, as well as user settings that are less likely to be changed during normal operation.

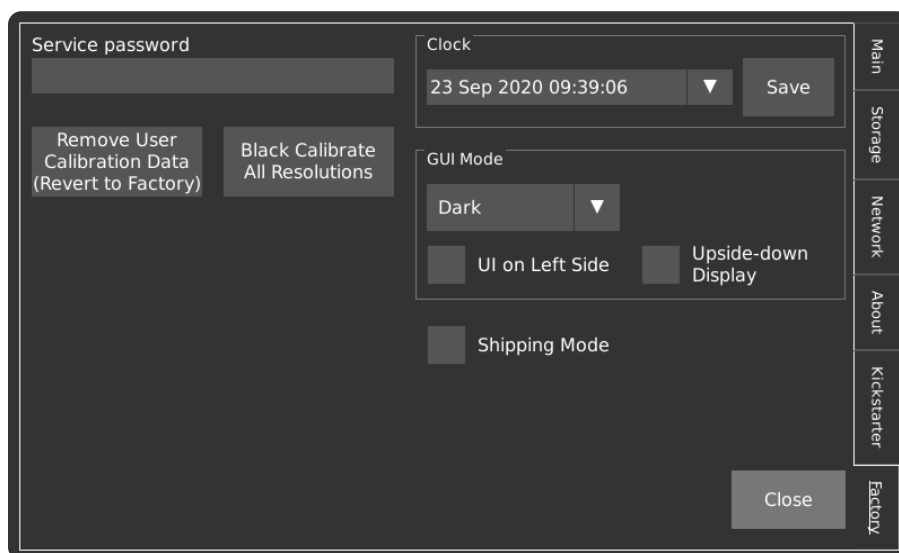

Control	Function
Service Password	Enters service mode. If used without the direction of Kron Technologies, the warranty is void.
Remove User Calibration Data (Revert to Factory)	Removes the saved Black Calibration data. Each time the <i>Black Cal</i> button on the Main screen is pressed, a calibration file is added to the system for the current combination of resolution and analog gain. This file is loaded the next time the prior combination of resolution and analog gain is used.
Black Calibrate All Resolutions	Performs Black Calibration at each level of analog gain for all the standard resolutions at their maximum frame rates. Standard resolutions can be found under the <i>Common Resolutions</i> dropdown box in the <i>Record Settings</i> screen. Please note that this may take up to 10 minutes.
Clock	Allows for the camera's date and time to be set. Press the Save button to assure that the settings persist on the next reboot of the camera.

FACTORY TAB [CONTINUED]

Control	Function
GUI Mode	Provides an option to change the theme of the Graphical User Interface (GUI) between dark and light modes.
UI on Left Side	Moves the vertical bar of controls on the Main screen to the left-hand side of the screen.
Upside-down Display	Rotates all contents of the display 180 degrees.
Shipping Mode	Disables the power button from starting the camera until an AC adapter is plugged in. This is to simplify transport of the camera when the battery is installed. Once the camera has been powered on with the AC adapter plugged in, the camera will automatically disable Shipping Mode for subsequent power cycles.