



POA400 – POA823 – POA824

■ User manual



Contents:

1. PRECAUTIONS AND SAFETY MEASURES	4
1.1. General	4
1.2. Preliminary instructions	4
1.3. During use	5
1.4. After use	5
2. GENERAL DESCRIPTION	6
2.1. Introduction	6
2.2. Functions	6
2.3. Initial screen	6
3. PREPARE TO USE	7
3.1. Initial check	7
3.2. Instrument power supply	7
3.3. Calibration	7
3.4. Storage	7
4. HOW TO OPERATE	8
4.1. Instrument description	8
4.2. Keyboard description	9
4.3. Display description	10
4.4. Reset of meter	10
5. GENERAL MENU	11
5.1. General settings	12
5.1.1. Language selection	12
5.1.2. Date/Time settings	13
5.1.3. Display brightness adjust	14
5.1.4. Protection Password setting	14
5.1.5. Sound keys setting	15
5.1.6. Auto power off setting	16
5.1.7. Memory type setting	17
5.1.8. "Touch screen" calibration	17
5.2. Real Time Values	18
5.2.1. Real time values	18
5.2.2. SCOPE waveforms screens	22
5.2.3. HARM analysis screens	24
5.2.4. Vectorial diagrams screens	26
5.3. Analyzer Settings	28
5.3.1. Analyzer Configuration screen	28
5.3.1.1. Setting system frequency	33
5.3.1.2. Setting clamp type	34
5.3.1.3. Setting full scale of clamps	34
5.3.1.4. Setting VT ratio	34
5.3.2. Advanced Settings screen	34
5.3.2.1. Zoom graphics option	35
5.3.2.2. Harmonics type option	35
5.3.2.3. Harmonics values option	36
5.3.2.4. Zoom with respect to the 1st harmonic option	36
5.3.2.5. Average value option	37
5.4. Recording settings	38
5.4.1. Recording settings screen	38
5.4.2. Comments	39
5.4.2.1. Use of virtual keyboard	39
5.4.3. Start and Stop	40
5.4.4. Integration period	40
5.4.5. Cogenerations	40
5.4.6. General Parameters	41
5.4.6.1. General Parameters: sub-levels description	43
5.4.6.2. Harmonics: sub-levels description	44
5.4.7. Voltage Anomalies	45
5.4.8. Inrush current (only PQA82x)	47
5.4.9. Flicker (only PQA82x)	48

5.4.10. Unbalance.....	49
5.4.11. Spike (only PQA824)	49
5.4.12. Predefined configurations.....	50
5.4.13. Start a recording	58
5.4.13.1. Automatic start of recording.....	60
5.4.14. During a recording	61
5.5. Saved data management section.....	63
5.5.1. Recording analysis (Reg type)	64
5.5.1.1. Recording information	64
5.5.1.2. Recording graph	65
5.5.1.3. Dips and swells.....	67
5.5.1.4. Fast transient.....	68
5.5.1.5. Inrush currents	70
5.5.1.6. EN50160	72
5.5.1.7. Analysis of consumed energy.....	74
5.5.1.8. Analysis of produced energy	75
5.5.2. Recording analysis (Istant type)	76
5.5.2.1. Recording information	76
5.5.2.2. Graph	77
5.5.2.3. Harmonics analysis	77
5.5.2.4. Vectors	78
5.5.2.5. Measures.....	79
5.5.3. Transfer recordings to a external Pen Driver USB.....	80
5.5.4. Saving recordings to external Compact Flash (only PQA82x)	81
5.6. Meter information	82
6. CONNECTION OF METER TO PC (WITH WIN XP).....	83
7. MEASURING PROCEDURES	84
7.1. Using of meter in a Single phase system – ENG type	84
7.2. Using of meter in a Single phase system – ENG_UK type	85
7.3. Using of meter in a 3-phase 4 wire system – ENG type.....	86
7.4. Using of meter in a 3-phase 4 wire system – ENG_UK type.....	87
7.5. Using of meter in a Three phase 3 wire system – ENG type	88
7.6. Using of meter in a Three phase 3 wire system – ENG_UK type	89
7.7. Using of meter in a Three phase 3 wire ARON system – ENG type	90
7.8. Using of meter in a 3-phase 3 wire ARON system – ENG_UK type	91
7.9. Using of meter in a 3-phase 4-wire 3PHL (USA system) – ENG type.....	92
7.10. Using in a 3-phase 4-wire 3PHL (USA system) – ENG_UK type.....	93
7.11. Using of meter in a 3-phase 3-wire 3POD (USA system) – ENG type.....	94
7.12. Using of meter in 3-phase 3-wire 3POD (USA system) – ENG_UK type.....	95
7.13. Using of meter in a 3 wire 3P2E (USA system) – ENG type	96
7.14. Using of meter in a 3 wire 3P2E (USA system) – ENG_UK type	97
7.15. Using of meter in a 3 wire 3POY (USA system) – ENG type	98
7.16. Using of meter in a 3 wire 3POY (USA system) – ENG_UK type	99
7.17. Using of meter in a 3 wire 1PH3W (USA system) – ENG type	100
7.18. Using of meter in a 3 wire 1PH3W (USA system) – ENG_UK type	101
8. MAINTENANCE.....	102
8.1. General	102
8.2. Situations relative to internal battery	102
8.3. Cleaning	102
8.4. End of life	102
9. TECHNICAL SPECIFICATIONS.....	103
9.1. Technical features.....	103
9.2. General features	105
9.3. Environment	105
9.3.1. Climatic condition	105
9.4. Accessories.....	105
10. APPENDIX – THEORETICAL OUTLINES.....	106
10.1. Voltage Anomalies	106
10.2. Voltage and current Harmonics.....	106
10.2.1. Theory.....	106

10.2.2.	Limit values for harmonic voltage	107
10.2.3.	Presence of harmonics: causes	108
10.2.4.	Presence of harmonics: consequences	108
10.3.	Inrush currents (only PQA82x)	109
10.4.	Flicker	110
10.5.	Supply voltage unbalance	111
10.6.	Voltage fast transients (spikes) (only PQA824)	112
10.7.	Power and power factor: definitions	114
10.7.1.	Conventions on powers and power factors	115
10.7.2.	Three phase 3 wire ARON system	116
10.8.	Measuring method: outlines	117
10.8.1.	Integration period	117
10.8.2.	Power factor calculations	117
11.	AFTER-SALE SERVICE	118
11.1.	Warranty	118
11.2.	Service	118

1. PRECAUTIONS AND SAFETY MEASURES

1.1. GENERAL

This meter has been designed in compliance to IEC/EN61010-1 directive. For your own safety and to avoid damaging the instrument we suggest you follow the procedures hereby prescribed and to read carefully all the notes preceded by the symbol .

Before and during measurements please take care of below points:

- Do not measure voltage or current in wet or dusty places.
- Do not measure in presence of gas, explosive materials or combustibles.
- Do not touch the circuit under test if no measurement is being taken.
- Do not touch exposed metal parts, unused terminals, circuits and so on.
- Do not use the meter if it seems to be malfunctioning (i.e. if you notice deformations, breaks, leakage of substances, absence of messages on the display and so on).

The below symbols are used in this manual and on meter:



Caution: keep to what prescribed by the manual. An incorrect use could damage the instrument or its components.



High voltage: risk of electric shock.



Double insulation.



The voltages indicates on the left of this symbol are referred to ground

1.2. PRELIMINARY INSTRUCTIONS

- This instrument has been designed for use in places with pollution class 2.
- It can be used for **VOLTAGE** and **CURRENT** measurements on installations of excess voltage CAT IV 600V to earth and a CAT III 1000V maximum voltage between inputs
- We recommend following the normal safety rules devised by the procedures for carrying out operations on live systems and using the prescribed PPE to protect the user against dangerous currents and the instrument against incorrect use
- In case the lack of warning against the presence of voltage may constitute a danger for the operator always carry out a continuity measurement before carrying out the measurement of the live system to confirm the correct connection and condition of the leads
- Only the accessories supplied with the instrument guarantee compliance with the safety standards. Accordingly, they must be in good conditions and, if necessary, they must be replaced with identical models.
- Do not take measurements on circuits exceeding the specified current and voltage limits.
- Before connecting cables, crocodiles and clamps to the circuit under test, make sure that the right function has been selected.

CAUTION



- Please perform a complete charging of internal battery for at least 5 hours before using the meter the first time.
- Please press and hold the **ON/OFF** key for about 5s when turning on the meter the first time.

1.3. DURING USE

Please read carefully the below points:



CAUTION

Should you fail to keep to the prescribed instructions you could damage the instrument and/or its components or endanger your safety.

- Do not touch any unused terminal when the meter is connected to the circuit on test.
- When measuring current, other currents located near the leads may affect the measuring accuracy.
- When measuring current, always position the wire in the very middle of the jaws in order to obtain the highest accuracy.
- A measured value remains constant if the "**HOLD**" function is active. Should you notice that the measured value remains unchanged, disable the "**HOLD**" function.

1.4. AFTER USE

- After use, turn off the instrument by pressing **ON/OFF** key for a few seconds.
- If you expect not to use the instrument for a long time please keep to the storage instructions described at § 3.4.

2. GENERAL DESCRIPTION

2.1. INTRODUCTION

This user manual is common to all meters and the PQA823, PQA824 models are indicated as “PQA82x”. The differences between meters, if necessary, are clearly declared in manual. Each model is generically called “meter”.

2.2. FUNCTIONS

This meter are able to performs:

- ✓ Real time visualization of numeric values of any electrical parameters of a single phase and three-phase 3-wire or 4-wire systems, harmonic analysis of voltages and currents up to 49st order, Voltage anomalies (surge and dips) with 10ms resolution, Flicker (Pst, Plt) of input voltages (PQA82x only), voltages unbalance, inrush current measurements (PQA82x only) and fast voltage transients analysis with 5 μ s resolution (PQA824 only).
- ✓ Real time display of any input signal waveform, histogram graphics of harmonics analysis and vectorial diagrams of mutual angles between voltages and currents.
- ✓ Recording (by pressing **GO/STOP** key) of this values: TRMS values of voltages, currents, corresponding harmonics, active, reactive and apparent powers, power factors and cosphi, active, reactive and apparent energies, voltage anomalies. **It will be possible to analyze the recorded data ONLY by transferring them to a PC.**
- ✓ Saving (by pressing **SAVE** key) of a “Instant” sampled of instantaneous values of any parameters present at instrument input inside memory. **It will be possible to analyze the memorized data ONLY by transferring them to a PC.**

2.3. INITIAL SCREEN

When turning on the instrument by pressing **ON/OFF** key, this below screen will appear for a few seconds:

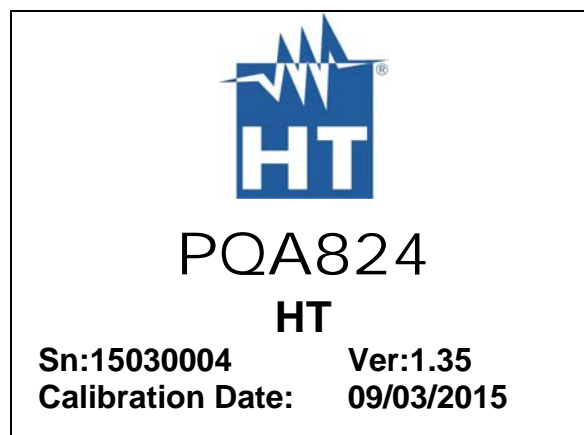

Here you can see (besides model code and manufacturer name):

- The serial number of the meter (Sn:).
- The release of internal meter Firmware (Rel:).
- Date of last calibration (Calibration Date:).

3. PREPARE TO USE

3.1. INITIAL CHECK

This meter has been checked before shipment from an electrical and mechanical point of view. All possible precautions have been taken in order to deliver it in perfect condition. Notwithstanding, on receipt of the instrument we suggest that you check it summarily to make sure that no damage has occurred in transit. Should you find irregularities please contact the carrier immediately.

Furthermore, please make sure that the parcel contains all the accessories and parts listed at enclosed packing list. In case of discrepancies please contact your dealer. Should it be necessary to return the instrument to the supplier please keep to the instructions given at chapter 11.

3.2. INSTRUMENT POWER SUPPLY

The instrument can be powered only by a rechargeable Li-ION battery (3.7V, 1900mAh) which is included with the meter. Use only the external adapter standard supplied with meter for charging battery (see § 8.2 for more details).



CAUTION

For recordings use **ALWAYS** the external adapter (even the instrument allows the operator to perform a recording using internal battery).



CAUTION

Please perform a complete charging of internal battery for at least 5 hours before the first use of meter.

The meter uses the below options to increase the battery duration:

- ✓ Automatically reduction of display brightness after about 30s from last operation performed with meter, with external adapter not connected.
- ✓ Auto Power OFF feature after about 5 minutes from the last operation on function keys or display touch screen with external adapter not connected (see § 5.1.6).

3.3. CALIBRATION

The instrument complies with the standards mentioned in this manual. Its performance is defined for 12 months from the purchase date.

3.4. STORAGE

To guarantee accurate measurements, after a long storage period in severe environmental conditions wait until the instrument resumes its normal conditions (see environmental conditions listed at § 9.3.1).

4. HOW TO OPERATE

4.1. INSTRUMENT DESCRIPTION

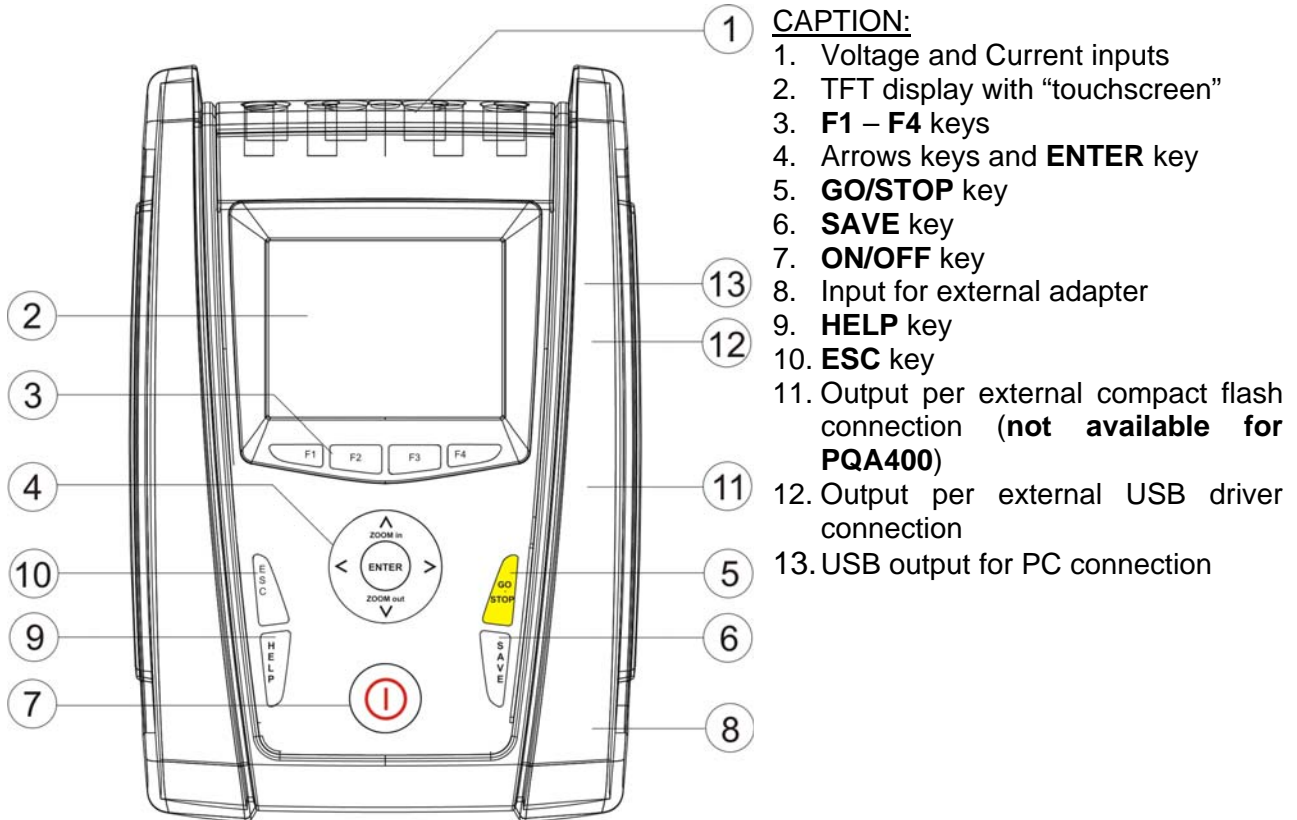

Fig. 1: Description of meter's front panel

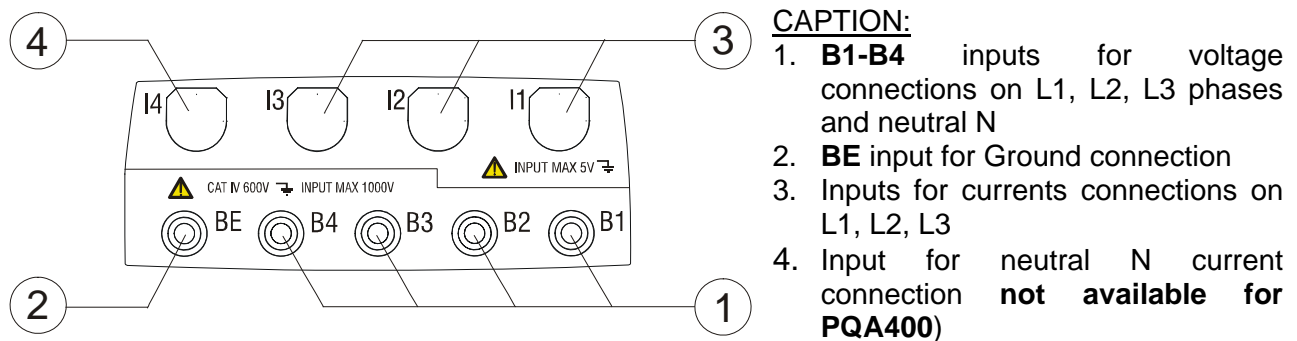

Fig. 2: Description of meter's input terminals

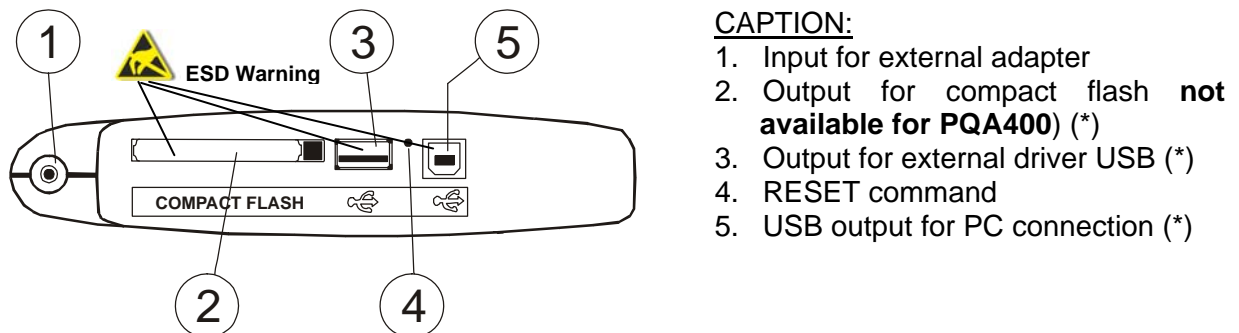

Fig. 3: Description of meter's output connectors

(*) Use the output connectors included into the lateral side only with meter OFF. This outputs should be interested by electrostatic discharges (ESD).

4.2. KEYBOARD DESCRIPTION

The below keys are available:

- ☞ Key **ON/OFF:** Press this key to turn on the meter. Press and hold the key for few seconds to turn off the meter.
- ☞ Keys **F1, F2, F3, F4:** Multifunction keys. The various functions are intended from the s shown on the bottom of display.
- ☞ Key **ESC:** To leave a menu or a sub-menu. The smart icon which is shown on screens performs the same function under interactive mode.
- ☞ Key **ENTER:** Double function key:
 - ✓ **ENTER:** To confirm the settings made.
 - ✓ **HOLD:** To block the value updating in all real time screens and also during a recording operation. "H" symbol is shown at display by any pressing of key as for Fig. 4

28/04/2015 17:51:56					
TOTAL RMS VALUES - Page 1/6					
V1N	V2N	V3N	VNPE		
0.0	0.0	0.0	0.0	V	
V12	V23	V31			
0.0	0.0	0.0	V		
NEG%	ZERO%	SEQ	Hz		
0.0	0.0	000	0.0		
I1	I2	I3	IN		
0.0	0.0	0.0	0.0	A	
PAGE	SCOPE	HARM	VECTORS		

Fig. 4: HOLD function active at display

- ☞ Keys **◀, ▲, ▶, ▼/ZOOM in/ZOOM out:** These arrows keys permit to select the desired programmable parameters inside various screens. The double function of **ZOOM in** and **ZOOM out** permits to change manually the full scale of some graphics inside SCOPE section in order to improve the global resolution on viewing waveforms of signals (see § 5.3.2). Arrow keys **◀** and **▶** permit to operate on internal pages inside some kinds of screen.
- ☞ Key **SAVE:** Saves an "Instant" type sampling of instantaneous values in internal memory (see § 5.5). The same key permits also the saving of various settings inside screens. The smart icon which is shown on screens perform the same function under interactive mode.
- ☞ Key **GO/STOP:** Permits to start/stop any recording (see § 5.4.13).
- ☞ Key **HELP:** Opens an help on line window on the meter screen with a short description of the same screen which is instantaneously shown. This key is active for any function.

4.3. DISPLAY DESCRIPTION

The display is a graphic TFT colour type, 73x57mm sizes (VGA 320x240 pxls) with “touch-screen” which permits a really easy operations using standard PT400 pointer pen fitted in lateral side of meter.

On first display’s row the system date/hour is shown by meter (see § 5.1.2 for settings). There are also some icons relative to battery level indication or external adapter fitted and for waiting and start of a recording. On second row the kind of selected measure is shown and the last row shows the short s associated to **F1**, **F4** function keys. An example of possible screen is shown on Fig. 5

28/04/2015 17:51:19				
X TOTAL RMS VALUES - Page 1/6				
V1N	V2N	V3N	VNPE	
0.0	0.0	0.0	0.0	V
V12	V23	V31		V
0.0	0.0	0.0		
NEG%	ZERO%	SEQ	Hz	
0.0	0.0	000	0.0	
I1	I2	I3	IN	
0.0	0.0	0.0	0.0	A
PAGE	SCOPE	HARM	VECTORS	

Fig. 5: Example of screen

4.4. RESET OF METER

The meter is designed with internal Reset Hardware which can be used if any functions is blocked at display, in order to restore all correct operations. Consider the below steps to perform Reset actions:

1. Using the PT400 pointer pen or another object softly pressing the internal part of the little hole which is present on the lateral side of meter (see Fig. 3 – 4). The meter goes automatically off.
2. Turn on the meter by pressing **ON/OFF** key and verify the correct working.

RESET operation **will not** erase the meter’s internal memory.

5. GENERAL MENU

Whenever you turn on the meter, the below “Analyzer Configuration” screen is shown, relative to the last configuration used (see Fig. 6):

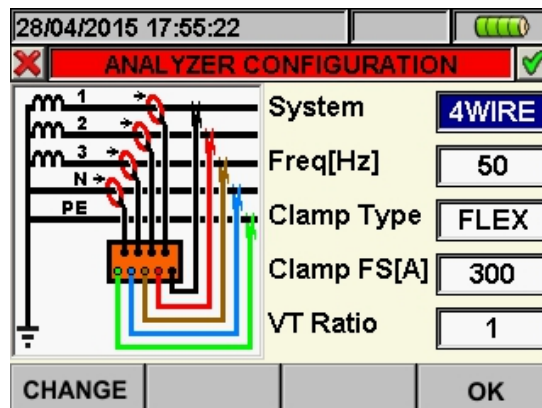

Fig. 6: Example of analyzer configuration

In this situation the user can decide whether modify the actual configuration by pressing **F1** key (or “**CHANGE**” at display – see § 5.3.1) or directly access to General Menu by pressing **F4** key (or the “**OK**” at display). If no action is performed within 10s the meter automatically goes to GENERAL MENU screen.

The GENERAL MENU of meter is correspondent to the screen shown in Fig. 7:

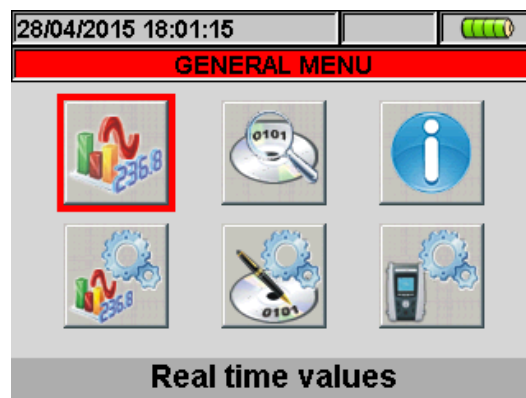

Fig. 7: GENERAL MENU screen

The actual selected section is shown with red background at display and it’s title is shown in the bottom of display. The below sections are available on meter:

- **General settings** section which permits to set the system parameters of meter as date/hour, language, display brightness, protection password, keys sound on pressure auto power off and memory type (see § 5.1).
- **Real time values** section which permits to see the real time measured values at display under various formats (see § 5.2).
- **Analyzer settings** section which permits to define the simple and advanced configurations relative to connection of meter to the installation (see § 5.3).
- **Recorder settings** section which permits to select the parameters for each recording and see the information about the autonomy of meter during operation (see § 5.4).
- **Recording results** section which permits to see the list of all recordings saved on internal memory, for memory cancel operations and the transfer of data in external Pen Driver USB (see § 5.5).
- **Meter information** section which permits to access to general information about meter (serial number, internal Firmware and Software release, etc...) (see § 5.6).

5.1. GENERAL SETTINGS

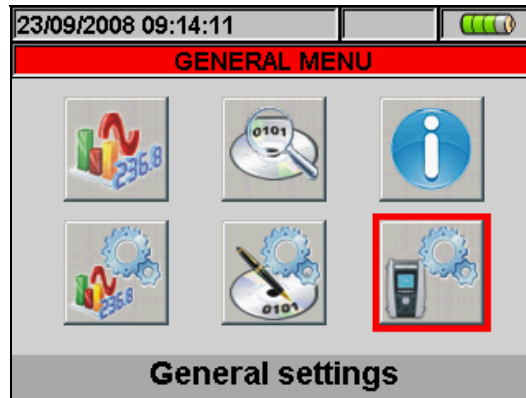

Fig. 8: MENU GENERAL screen - General settings section

This section permits to set the below control parameters:

- System language.
- System Date/Hour.
- Display brightness.
- Protection password during recordings.
- Key sound on pressure.
- Auto Power OFF Enable/Disable.
- Memory type settings

Pressing **ENTER** key (or touch the relative icon at display). The below screen is shown by meter:

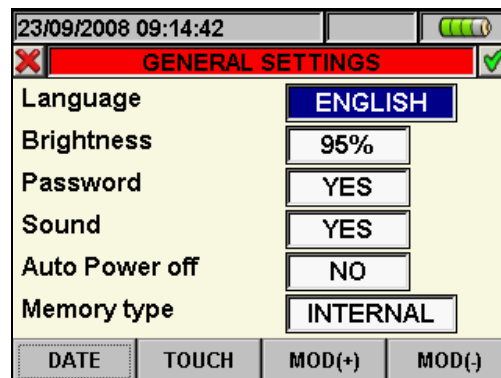

Fig. 9: General Settings screen

5.1.1. Language selection

1. Move the cursor using arrows keys on field relative to "Language", marked with blue background.
2. Using **F3** or **F4** keys (or touch **MOD(+)** o **MOD(-)**) for selection of language choosing among the different options.
3. Pressing **SAVE** or **ENTER** keys (or the smart icon) to save the selected option and confirm by "Ok". This selected parameter will be present also the turning off of meter.
4. Pressing **ESC** key (or the smart icon) to exit by screen without saving any modify.



CAUTION

Changing the language form ENGLISH to ENGLISH_UK the colour of the input cables is modified for any system (see § 5.3.1)

5.1.2. Date/Time settings

1. Press the **F1** key (or touch **DATE** at display) on screen of Fig. 9. The below screen is shown by meter:

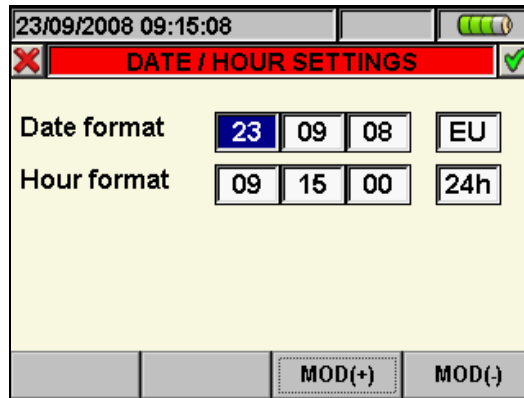



Fig. 10: Date/Time settings screen

2. Move the cursor using arrows keys on field relative to “Date format” and “Time format”, marked with blue background.
3. Using **F3** or **F4** keys (or touch **MOD(+)** o **MOD(-)**) for Date setting choosing between the two possible formats (European EU or American US):

DD:MM:YY	Option EU
MM:DD:YY	Option US

4. Using **F3** or **F4** keys (alternatively touch **MOD(+)** o **MOD(-)**) for Time setting choosing between two possible format (24 hours or 12 hours):

HH:MM:SS	Option 24h
HH:MM:AM(PM)	Option 12h

5. Press **SAVE** or **ENTER** keys (or the smart icon ) to save the selected option and confirm by “Ok”. This selected parameter will be present also the turning off of meter.
6. Pressing **ESC** key (or the smart icon ) to exit by screen without saving any modify.

5.1.3. Display brightness adjust

1. Move the cursor using arrows keys on the field relative to “Brightness”, marked with blue background

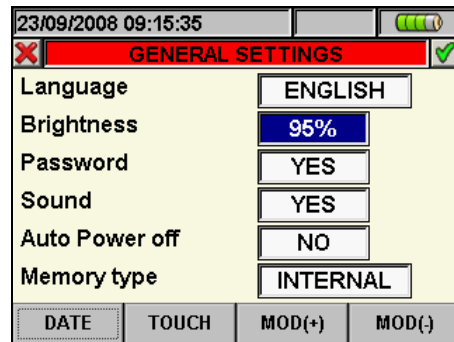



Fig. 11: Adjust brightness screen

2. Using **F3** or **F4** keys (alternatively touch **MOD(+)** o **MOD(-)**) for adjustment of display brightness percentage. The meter increases or decreases this value in step of 5% for each pressure of key.
3. Press **SAVE** or **ENTER** key (or the smart icon ) to save the selected option and confirm by “Ok”. This selected parameter will be present also the turn off of meter.
4. Press **ESC** key (or the smart icon ) to quit without saving any modification.

5.1.4. Protection Password setting

The meter is provided with a protection password to avoid the risk of accidental recording interruption.

1. Move the cursor using arrows keys on field relative to “Password” , marked it with blue background

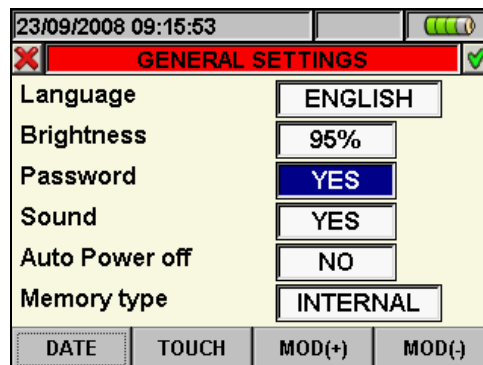

Fig. 12: Protection password settings screen

2. Use **F3** or **F4** keys (alternatively touch **MOD(+)** o **MOD(-)**) to enable “YES” or disable “NO” of Password.

- With Password enabled, should **GO/STOP** key be pressed during a recording, the meter will not stop the operation but will require the user to insert password as shown in the below screen:

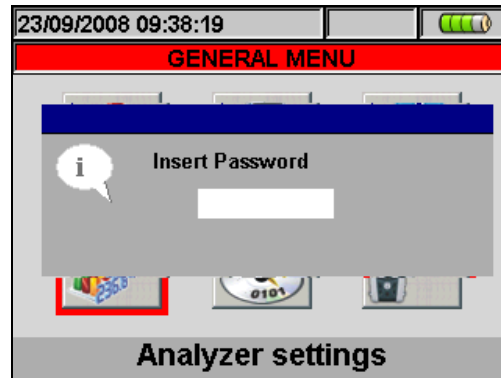

Fig. 13: Insert Password screen

- The fixed password (**not changeable by user**) to insert on meter within 10s from warning message is the below sequence of keys:

F1, F4, F3, F2

- If a wrong password is fitted or if more of 10s elapse, the meter will give the warning message “Wrong Password” and it’s necessary to repeat the operation. As soon as the correct password is fitted, the meter will stop immediately the recording running and the correspondent icon at display (see
- Press **SAVE** or **ENTER** keys (or the smart icon) to save the selected option and confirm by “Ok”. This selected parameter will be present also after turning off the meter.
- Pressing **ESC** key (or the smart icon) to quit without saving any modification.

5.1.5. Sound keys setting

The meter permits to enable a instantaneous sound for any key pressure of the frontal panel.

- Move the cursor using arrows keys on field relative to “Sound”, marked with blue background, see

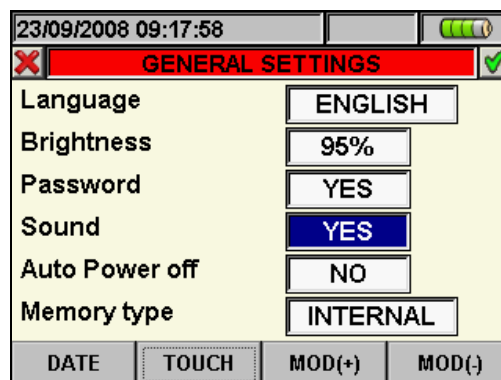

Fig. 14: Keys sound settings screen

- Use **F3** or **F4** keys (alternatively touch **MOD(+)** o **MOD(-)**) to enable “**YES**” or disable “**NO**” of keys sound.
- Pressing **SAVE** or **ENTER** keys (or the smart icon) to save the selected option and confirm by “Ok”. This selected parameter will be present also after turning off the meter.
- Press **ESC** key (or the smart icon) to quit without saving any modification.

5.1.6. Auto power off setting

The meter permits to enable or disable the auto power off option in order to prevent a quick discharge of internal battery. This feature, if selected, is active under each of the following conditions:

- No action was performed both any key or touch display for at least **5 minutes**.
- Meter does not supplied with external adapter.
- Meter does not in recording running.

The effect is a long sound before turn off of meter.

1. Move the cursor using arrows keys on the field relative to “Auto power off”, marked with blue background, see

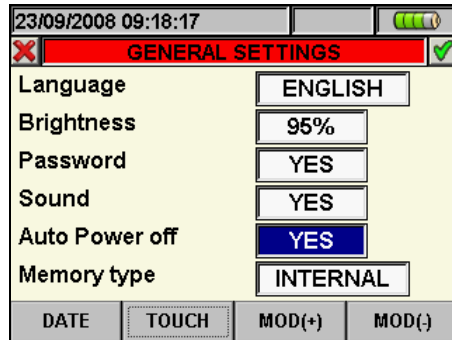



Fig. 15: Auto power off setting screen

2. Use **F3** or **F4** keys (alternatively touch **MOD(+)** o **MOD(-)**) for enable “**YES**” or disable “**NO**” auto power off.
3. Press **SAVE** or **ENTER** keys (or the smart icon ) to save the selected option and confirm by “Ok”. This selected parameter will be present also after turning off the meter.
4. Press **ESC** key (or the smart icon ) to quit without saving any modification.

5.1.7. Memory type setting

The meter permits saving of recordings both in its internal memory (about 15Mbytes) and by using an external compact flash (see § 5.5.4 for details) fitted (see Fig. 3). For the selection of memory type follow the below steps:

1. Move the cursor using arrows keys on field relative to “Memory type”, marked with blue background

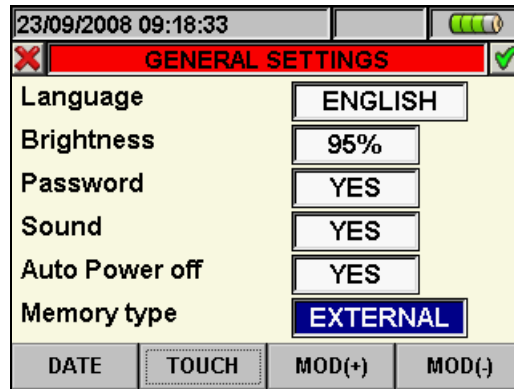



Fig. 16: Memory type setting screen

2. Use **F3** or **F4** keys (alternatively touch **MOD(+)** or **MOD(-)**) to choose “**INTERNAL**” or “**EXTERNAL**” memory type.
3. Press **SAVE** or **ENTER** keys (or the smart icon ) to save the selected option and confirm by “Ok”. This selected parameter will be present also after turning off the meter.
4. Press **ESC** key (or the smart icon ) to exit by screen without saving any modify.

5.1.8. “Touch screen” calibration

This operation is necessary if any internal features of “touch screen” display are not correctly positioned or not more selectable by using the PT400 pointer

1. Select the “TOUCH” item inside the “General settings” section. The message “Do You want to calibrate touch screen?” is shown by the meter. Confirm with “Ok”. The herewith screen is shown:

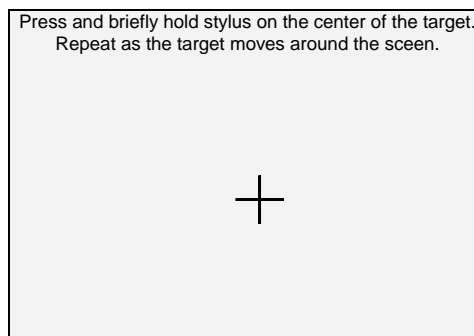

Fig. 17: Touch screen calibration screen

2. By pressing and soft hold the PT400 pointer on the central point of the cross cursor (see Fig. 17) move the cursor to the four corners of display
3. Switch off and then turn on the meter by means of **ON/OFF** key to complete the operation

5.2. REAL TIME VALUES

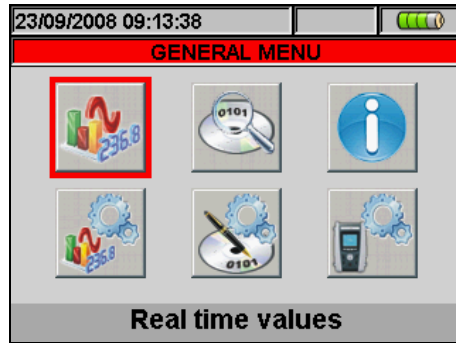

Fig. 18: MENU GENERAL screen - Real time values section

In this section the real time measured values of parameters both on input channels and internally calculated are shown by meter. In particular are shown the AC TRMS voltages, currents and all kind of electrical parameters for any single phase and total, Flicker values and voltages Unbalanced, voltage and current waveforms for any single phase and total, voltage and current harmonics up to 49th component for any single phase and total both in numerical and histograms graphical format in absolute or percentage value with respect to each fundamental signal and vectorial diagrams of each voltage and current with the respective phase angles in order to define the correct nature of system loads under test.

5.2.1. Real time values

As an example, below are shown the screens relative to a **three phase 4-wire system**. Similar consideration can be applied to any other selected system. Further in this manual the expression “Page x/y” will be used, to indicate that the current page number (x) and the total number of pages (y) depend on the instrument settings. Pressing cyclically **F1** key or arrow keys left of right the meter shows the other pages of TRMS measured values which are described in below pictures. Pressing **ESC** key to go back to previous screens or back to GENERAL MENU

29/04/2015 09:50:33				[Battery Icon]	
TOTAL RMS VALUES - Page 1/8					
V1N	V2N	V3N	VNPE		
0.0	0.0	0.0	0.0	V	
V12	V23	V31			
0.0	0.0	0.0	V		
NEG%	ZERO%	SEQ	Hz		
0.0	0.0	000	0.0		
I1	I2	I3	IN		
0.0	0.0	0.0	0.0	A	
PAGE	SCOPE	HARM	VECTORS		

PARAMETERS CAPTION

- V1N → Phase-Neutral voltage L1 phase
- V2N → Phase-Neutral voltage L2 phase
- V3N → Phase-Neutral voltage L3 phase
- VNPE → Neutral-Ground voltage
- V12 → Phase L1 – Phase L2 voltage
- V23 → Phase L2 – Phase L3 voltage
- V31 → Phase L3 – Phase L1 voltage
- NEG% → Unbalance percentage of negative tern
- ZERO% → Unbalance percentage of zero tern
- SEQ → phases sequence indication as:
 - "123" = > Corrected
 - "132" = > Reversed
 - "023" = > Null voltage on the Black wire
 - "103" = > Null voltage on the Red wire
 - "120" = > Null voltage on the Brown wire
 - "100" = > Null voltage on the Red and Brown wires
 - "020" = > Null voltage on the Black and Brown wires
 - "003" = > Null voltage on the Black and Red wires
- Hz → Frequency
- I1 → Current on L1 phase
- I2 → Current on L2 phase
- I3 → Current on L3 phase
- IN → Current on Neutral (**not avail. for PQA400**)

Fig. 19: Page of numerical values

29/04/2015 09:52:16			
TOTAL POWER VALUES - Page 2/8			
Pact	=	0.0 kW	
Preact	=	0.0 kVAr	
Papp	=	0.0 kVA	
Pf	=	0.00 i	
CosPhi	=	0.00 i	
PAGE	SCOPE	HARM	VECTORS

PARAMETERS CAPTION:

- Pact → Total Active Power
- Preact → Total Reactive Power
- Papp → Total Apparent Power
- Pf → Total Power Factor
- CosPhi → Total Power factor considering fundamental
→ of voltage and current signals

Fig. 20: Page of total power values

29/04/2015 09:52:27			
PHASE 1 RMS VALUES - Page 3/8			
V1N	=	0.0 V	
I1	=	0.0 A	
Pact1	=	0.0 kW	
Preact1	=	0.0 kVAr	
Papp1	=	0.0 kVA	
Pf1	=	0.00 i	
CosPhi1	=	0.00 i	
PAGE	SCOPE	HARM	VECTORS

PARAMETERS CAPTION:

- V1N → Phase-Neutral voltage L1 phase
- I1 → Current on L1 phase
- Pact1 → Active Power L1 phase
- Preact1 → Reactive Power L1 phase
- Papp1 → Apparent Power L1 phase
- Pf1 → Power factor L1 phase
- CosPhi1 → Power factor between fundamental of
→ voltage L1 and current L1

Fig. 21: Page of Phase 1 values

29/04/2015 09:52:34			
PHASE 2 RMS VALUES - Page 4/8			
V2N	=	0.0 V	
I2	=	0.0 A	
Pact2	=	0.0 kW	
Preact2	=	0.0 kVAr	
Papp2	=	0.0 kVA	
Pf2	=	0.00 i	
CosPhi2	=	0.00 i	
PAGE	SCOPE	HARM	VECTORS

PARAMETERS CAPTION:

- V2N → Phase-Neutral voltage L2 phase
- I2 → Current on L2 phase
- Pact2 → Active Power L2 phase
- Preact2 → Reactive Power L2 phase
- Papp2 → Apparent Power L2 phase
- Pf2 → Power factor L2 phase
- CosPhi2 → Power factor between fundamental of
→ voltage L2 and current L2

Fig. 22: Page of Phase 2 values

29/04/2015 09:52:40			
PHASE 3 RMS VALUES - Page 5/8			
V3N	=	0.0 V	
I3	=	0.0 A	
Pact3	=	0.0 kW	
Preact3	=	0.0 kVAr	
Papp3	=	0.0 kVA	
Pf3	=	0.00 i	
CosPhi3	=	0.00 i	
PAGE	SCOPE	HARM	VECTORS

PARAMETERS CAPTION:

- V3N → Phase-Neutral voltage L3 phase
- I3 → Current on L3 phase
- Pact3 → Active Power L3 phase
- Preact3 → Reactive Power L3 phase
- Papp3 → Apparent Power L3 phase
- Pf3 → Power factor L3 phase
- CosPhi3 → Power factor between fundamental of
→ voltage L3 and current L3

Fig. 23: Page of Phase 3 values

29/04/2015 09:52:48			
FLICKER - Page 6/8			
Pst1'	V1N	V2N	V3N
Pst	--	--	--
Pst max	--	--	--
Plt	--	--	--
Plt max	--	--	--
Recording time:	--	--	--
PAGE	SCOPE	HARM	VECTORS

Fig. 24: Page of Flicker values

PARAMETERS CAPTION:

Pst1' → Short term severity after 1 minute
 Pst → Short term severity
 Pstmax → Maximum short term severity
 Plt → Long term severity
 Pltmax → Maximum long term severity
 Recording Time → real time duration of recording expressed in HH:MM

29/04/2015 09:52:54			
TOT. ENERGY CONSUMPTION - Pag 7/8			
Eact	=	0 kWh	
Ppeak	=	0 kW	
Date Ppeak	:	--/--/--	00:00:00
Start rec.	:	--/--/--	00:00:00
Stop rec.	:	--/--/--	00:00:00
Rec. Time	:	--	--
Int. Per.	:	--	Rec. : --
PAGE	SCOPE	HARM	VECTORS

Fig. 25: Consumed energy page

PARAMETERS CAPTION:

Eact → Total active energy consumed when starting recording.
 Ppeak → Maximum peak of consumed active power.
 Date Ppeak → Date and time in which the peak occurred.
 Start rec. → Date when recording was started.
 Stop rec. → Date when recording was stopped.
 Rec. Time → Time elapsed from Rec Start.
 Int. Per. → Value of the set integration period.
 Rec → Number of the recording in progress

CAUTION



The Total Consumed Energy page is shown only if the instrument has been set for the Recording of the General Parameter Total "Active Power & Energy" (see § 5.4.6.1). Values will be shown only during or at the end of a recording and zeroed upon starting a new recording or when the instrument is switched off

29/04/2015 10:23:15			
TOT. ENERGY PRODUCTION - Pag 8/8			
Eact	=	0 kWh	
Ppeak	=	0 kW	
Date Ppeak	:	--/--/--	00:00:00
Start rec.	:	--/--/--	00:00:00
Stop rec.	:	--/--/--	00:00:00
Rec. Time	:	--	--
Int. Per.	:	--	Rec. : --
PAGE	SCOPE	HARM	VECTORS

Fig. 26: Produced energy page

PARAMETERS CAPTION:

Eact → Total active energy produced when starting recording.
 Ppeak → Maximum peak of produced active power.
 Date Ppeak → Date and time in which the peak occurred.
 Start rec. → Date when recording was started.
 Stop rec. → Date when recording was stopped.
 Rec Time → Time elapsed from Rec Start.
 Int. Per. → Value of the set integration period.
 Rec → Number of the recording in progress

CAUTION



The Total Produced Energy page is shown only if recording parameter "Co-generation" has been set in the instrument (see § 5.4.5) and if general parameter Total "Active Power & Energy" has been selected (see § 5.4.6.1). Values will be shown only during or at the end of a recording and zeroed upon starting a new recording or when the instrument is switched off.

29/04/2015 10:24:03			
AVERAGE RMS VALUES - Page 9/9			
AVG V	=	0.0 V	
AVG I	=	0.0 A	
AVG Pact	=	0.0 kW	
AVG Preact	=	0.0 kVAr	
PAGE	SCOPE	HARM	VECTORS

PARAMETERS CAPTION:

AVGV → Average value voltage V1, V2, V3
AVGI → Average value current I1, I2, I3
AVGPact → Average value active power on L1, L2, L3
AVGPreact → Average value reactive power on
→ L1,L2,L3

Fig. 27: Page of numerical average values

**CAUTION**

The AVERAGE RMS VALUES page will be shown only if option AVERAGE VALUES "YES" is enabled in the Advanced Settings section (see § 5.3.2.5)

5.2.2. SCOPE waveforms screens

Starting from a any page of numerical values it's possible to select waveforms screens of the input signals by pressing **F2** key (or touch **SCOPE** at display). By pressing cyclically **F1** key the below screens are shown by meter.

As an example, below are shown the screens relative to a **three phase 4-wire system**. Similar consideration can be applied to any other selected system

- Simultaneous waveforms of voltages V1, V2, V3 and neutral voltage Vn (for three phase 4-wire system and single phase), with their TRMS values as shown in below screens:

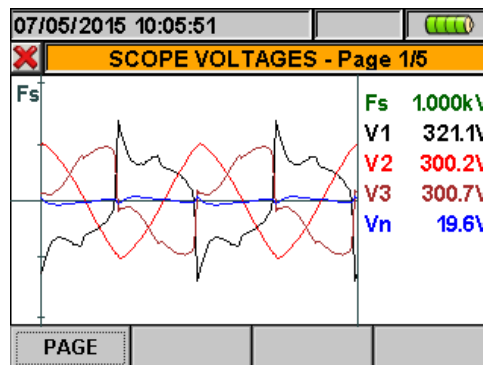

Fig. 28: Voltage waveforms screen for 4-wire systems

- Simultaneous waveforms of currents I1, I2, I3 and neutral current In (for three phase 4-wire system – **not available for PQA400**), with their TRMS values as shown in below screens:

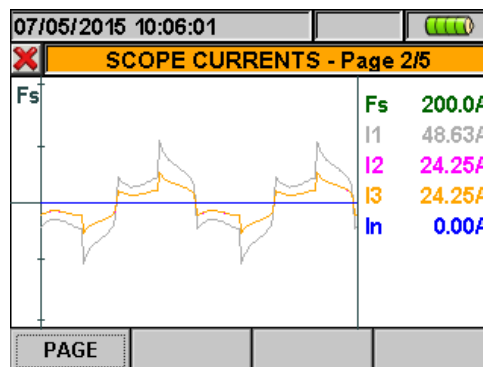

Fig. 29: Current waveforms screen for 4-wire systems

- Waveforms of signals on L1 phase, with their TRMS values, as below shown:

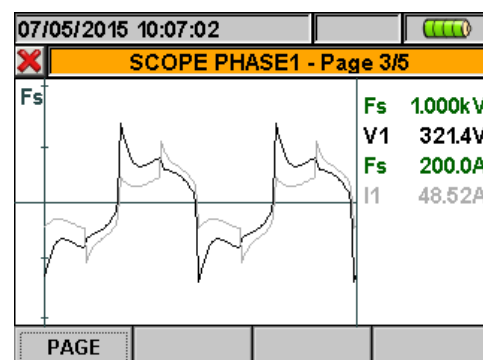

Fig. 30: Voltage/Current waveforms screen L1 phase for 4-wire and 3-wire systems

- Waveforms of signals on L2 phase, with their TRMS values, as below shown:

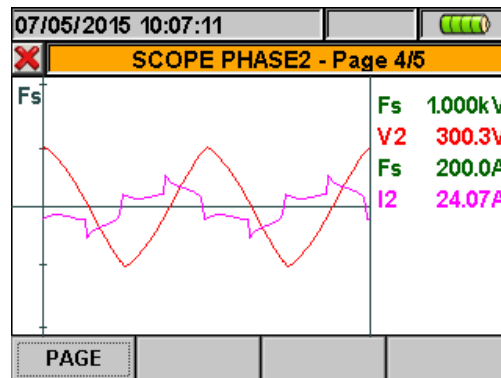

Fig. 31: Voltage/Current waveforms screen L2 phase for 4-wire systems

- Waveforms of signals on L3 phase, with their TRMS values, as below shown:

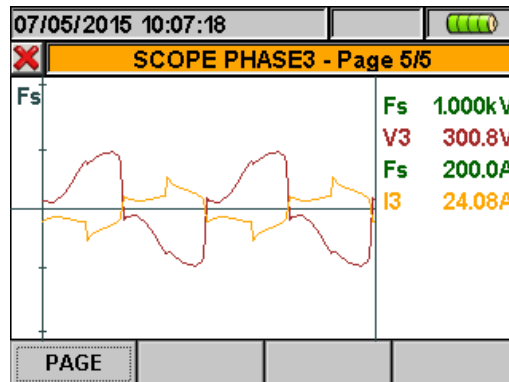



Fig. 32: Voltage/Current waveforms screen L3 phase for 4-wire systems

In Manual mode inside Advanced Settings (see § 5.3.2.1) a customisation of full scale of voltage and current graphic is possible in order to improve the resolution on readings. In this situation pressing arrow keys **ZOOM in** or **ZOOM out** for increase or decrease the value of desired full scale. Press **F2** key to change from current full scale to voltage full scale. Press **ESC** key (or the smart icon ) to quit waveforms screens and go back to TRMS real time values screen.

5.2.3. HARM analysis screens

Starting from any page of numerical values it's possible to enter harmonics numerical values and histogram graphics screens section for voltage and current input signals by pressing **F2** key (or touch **HARM** at display). By pressing cyclically **F1** key the below screens are shown by meter.

As an example, below are shown the screens relative to a **three phase 4-wire system**. Similar consideration can be applied to any other selected system.

- Harmonics values of V1, V2, V3 voltages and neutral voltage Vn (for three phase 4-wire system – **not available for PQA400**), currents I1, I2, I3 and neutral current In (for three phase 4-wire system) with THD% values both with histogram graphics and with numerical values in percentage or absolute value, (see § 5.3.2.3 as below shown. The **positive** value means the condition of **absorbed** harmonics (mains → loads direction) while the **negative** value means the condition of **generated** harmonics (loads → mains direction)

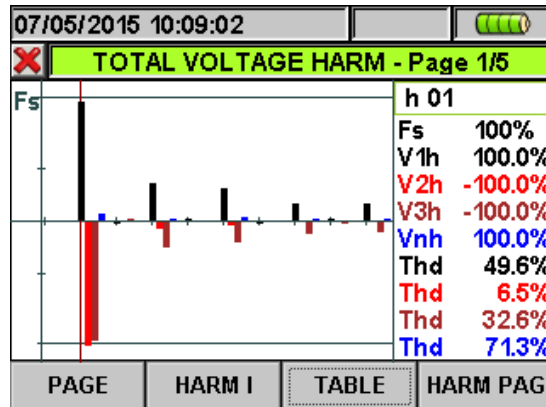

Fig. 33: Harmonic analysis of voltages in percentage value for 4-wire systems
In all case the full scale of graphs is automatically set from meter depending on measured values.

- Change to currents screens by pressing **F2** key (or touch “**HARM I**” at display). By pressing **F1** key (or the **PAGE** at display) the screens of total values and each phase currents I1, I2, I3 and In (for 4-wire and single phase systems). The main screens are below shown:

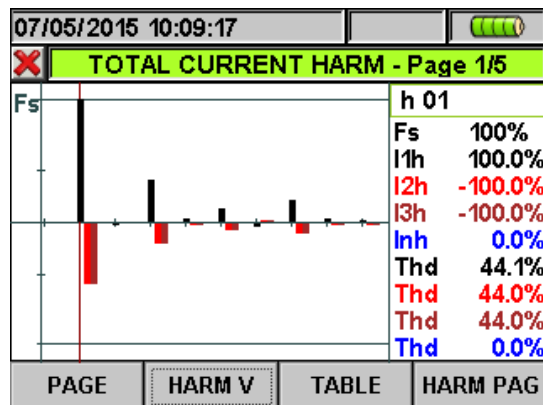

Fig. 34: Harmonic analysis of currents percentage/absolute for 4-wire systems

- Change to screens of numerical values tables of harmonics voltages and currents up to 49st both percentage and absolute value (see § 5.3.2.3) by pressing **F3** key (or touch “**TABLE**” at display), as shown in below pictures:

07/05/2015 10:09:32				
VOLTAGE HARMONICS				
h%	Phase 1	Phase 2	Phase 3	Neutral
Thd%	49.9	6.6	32.8	70.9
Dc	0.0	0.0	0.0	0.0
h1	100.0	-100.0	-100.0	100.0
h2	-1.2	0.5	0.9	0.9
h3	30.9	-6.1	-21.0	36.4
h4	0.9	0.1	-0.6	1.3

HARM I GRAPHIC HARM PAG

Fig. 35: Harmonic analysis voltages in percentage value for 4-wire systems

07/05/2015 10:09:40				
CURRENT HARMONICS				
h%	Phase 1	Phase 2	Phase 3	Neutral
Thd%	43.9	43.8	43.8	0.0
Dc	0.0	0.0	0.0	0.0
h1	100.0	-100.0	-100.0	0.0
h2	-1.5	1.4	1.4	0.0
h3	33.9	-33.8	-33.8	0.0
h4	2.9	-2.9	-2.9	0.0

HARM V GRAPHIC HARM PAG

Fig. 36: Harmonic analysis currents in percentage value for 4-wire systems

Press **F3** key to back to graphical screens and **F2** key to change voltages' or currents' screens. Press **F4** key or the up and down arrows (or touch the "HARM PAG" at display) to show the screens relative to other harmonics orders up to 49st.

- Harmonics values of single V1, V2, V3 voltages and neutral voltage Vn and single currents I1, I2, I3 and neutral current In (for three phase 4-wire system – **not available for PQA400**) with THD% values both with histogram graphics and with numerical values in percentage or absolute value depending on the desired settings. These values are shown in four pages selectable by pressing cyclically the **F1** key (or touch the "PAGE" at display). On Fig. 37 and Fig. 38 are display as an example, the situation relative to L1 phase for voltage and current on 4-wire systems is shown in the next pictures:

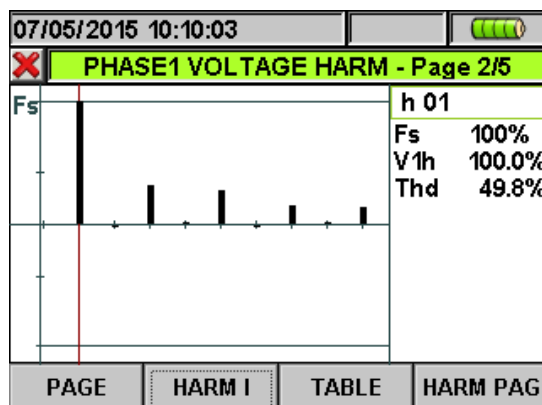

Fig. 37: Harmonic analysis voltage V1 in percentage values for 4-wire system

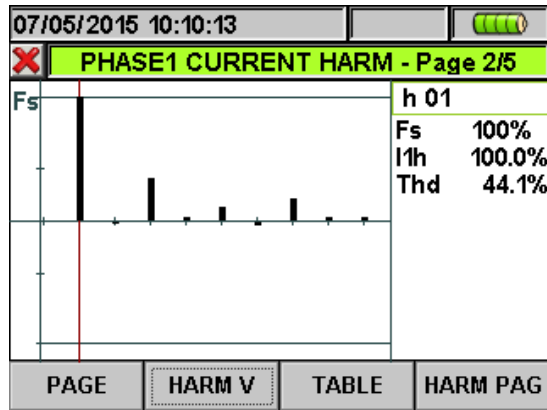

Fig. 38: Harmonic analysis of current I1 in percentage/absolute values for 4-wire system

5.2.4. Vectorial diagrams screens

Starting from a any page of numerical values it's possible to select the vectorial diagrams screens of voltage and currents by pressing **F4** key (or touch "VECTORS" at display). The aim of this feature is to show, with numerical and graphical indications, the phase angles, expressed in degree [°] between the three voltages V1, V2 and V3 and the currents I1, I2 and I3 in order to understand in each moment the inductive or capacitive loads nature of electrical installations. As an example, below are shown the screens relative to a **three phase 4-wire system**. Similar consideration can be applied to any other selected system. By pressing cyclically **F1** key the below screens are shown by meter:

- Vectorial diagram total of phase angles among V1, V2, V3 and between V1-I1, V2-I2, V3-I3 more than indication of percentage values of "NEG%" e "ZERO%" parameters (see § 10.5):

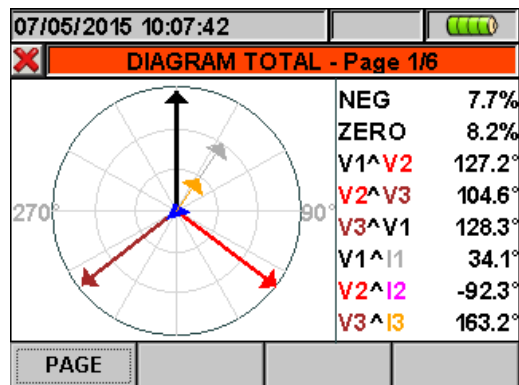

Fig. 39: Vectorial diagram total for 4-wire system

- The vectorial diagram of single voltages depending on the type of selected systems as shown in below screens:

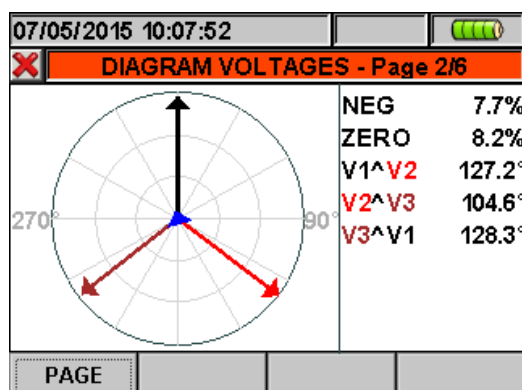

Fig. 40: Vectorial voltage diagram for 4-wire system

- The vectorial diagram of voltage and current for each phase depending on the type of system as shown in below screens:

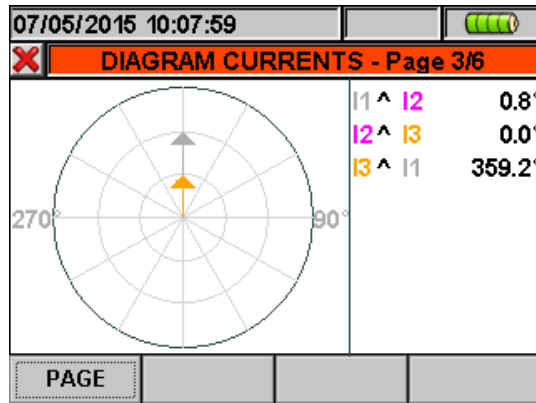

Fig. 41: Vectorial current diagram for 4-wire system

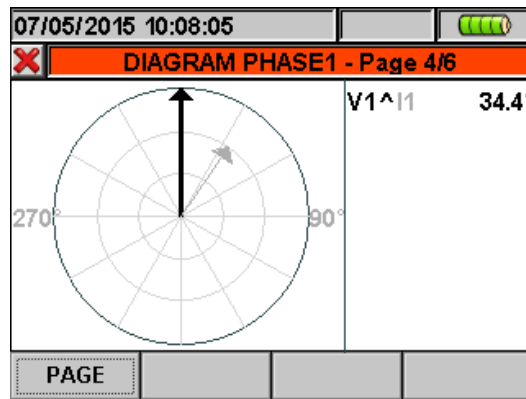



Fig. 42: Vectorial voltage/current diagram L1 phase for 4-wire system

Pressing **ESC** key (or smart icon  at display) to exit from each screen and back to the previous one.

CAUTION



- The vectors of voltages are referred to the external circle on each diagram and the vectors of current are referred to second circle. The vectors' sizes are designed so that the vector of maximum amplitude can touch the circle and the other vectors are scaled with respect to it proportionally to their amplitude.
- The rotation positive reference associated at each vectorial diagram is **clockwise**.

5.3. ANALYZER SETTINGS

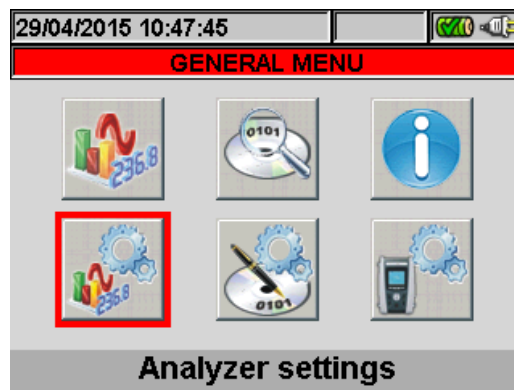

Fig. 43: Analyzer settings screen

Inside this section the meter permits to perform basic and advanced selections relative to the type of electrical installation under test. In particular it is possible to

- Select the type of system, the frequency, the kind of current clamp, the full scale of current clamp and the VT ratio of external voltage transformer which can be connected with meter (Analyser Configuration)
- Setting the Manual mode for the customisation of full scale on graphic screen of Real Time section, the type of harmonic to be shown on screens, the percentage or absolute values of harmonics, the harmonics zoom, the average calculation of voltages, currents, active and reactive powers (Advanced Settings).

We suggest use of icons and in order to perform a complete interaction with the meter.

5.3.1. Analyzer Configuration screen

Inside the “Analyzer configuration” section a screen depending on the type of system selected by user during the last operation is shown by meter: **The instrument is granted for a correct measurement only in connection with the following electrical systems:**

- Three phase system **4WIRE** (Three phase four wire WYE system + ground) – ENG & ENG_UK
- Three phase system **3WIRE** (Three phase system three wire WYE (no Neutral) + ground) – ENG & ENG_UK
- Three phase system **ARON** (Three phase system three wire DELTA ARON - 2 wattmeter method + ground) – ENG & ENG_UK
- SINGLE phase system (phase + neutral+ ground) – ENG & ENG_UK
- Three phase system 4-wire “**3PHL** (Three phase four wire DELTA system with center tapped high leg + ground – USA systems (ENG & ENG_UK)
- Two phase system 3-wire “**3POY** (Open WYE three wire system with 2 transformer windings + ground)” – USA systems (ENG & ENG_UK)
- Three phase system 3-wire “**3POD**” (Open DELTA three wire system with 2 transformer windings + ground)” – USA systems (ENG & ENG_UK)
- Two phase system 3-wire “**3P2E** (Three phase three wire system without Voltage/current sensor on phase L3 + ground)” – USA systems (ENG & ENG_UK)
- Two phase system 3-wire “**1Ph3W**” (Split phase + ground) – USA systems (ENG & ENG_UK)



CAUTION

Changing the language form ENGLISH to ENGLISH_UK the colour of the input cables is modified for any system

Below the possible screens of above systems’ options are described:

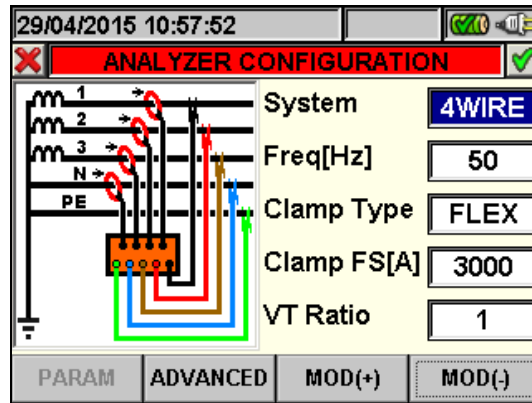

Fig. 44: Analyzer configuration screen for 4-wire system – ENG type

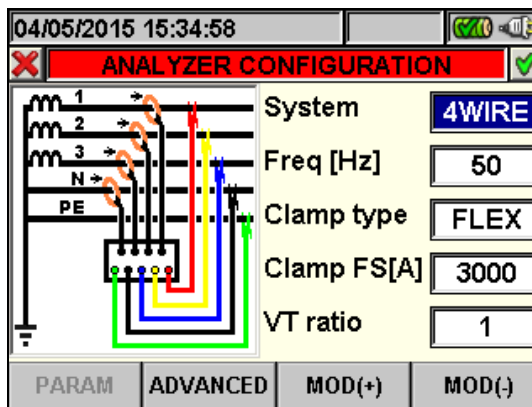

Fig. 45: Analyzer configuration screen for 4-wire system – ENG_UK type

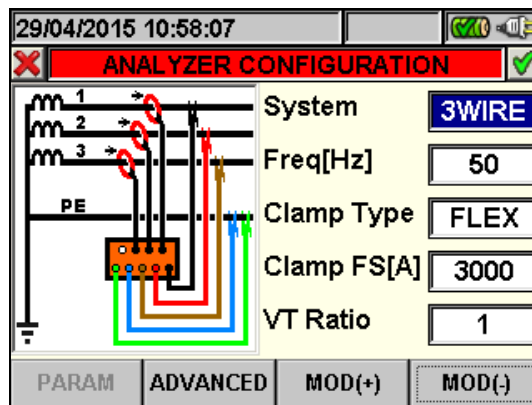

Fig. 46: Analyzer Configuration screen for 3-wire system – ENG type

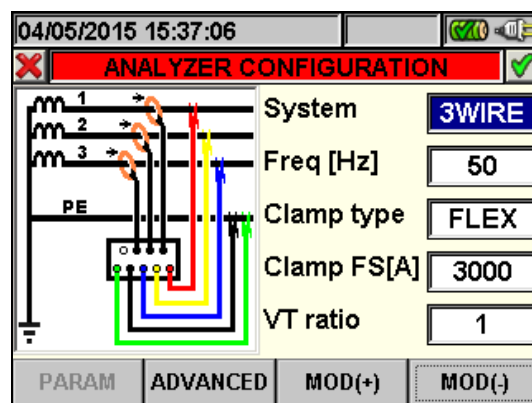

Fig. 47: Analyzer Configuration screen for 3-wire system – ENG_UK type

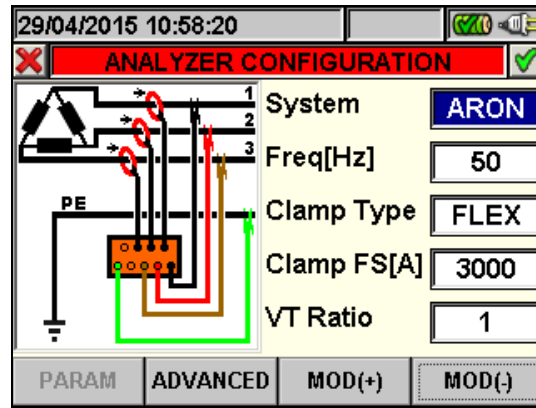

Fig. 48: Analyzer Configuration screen for ARON system – ENG type

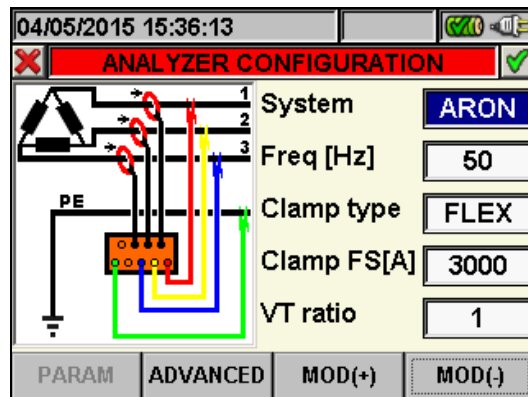

Fig. 49: Analyzer Configuration screen for ARON system – ENG_UK type

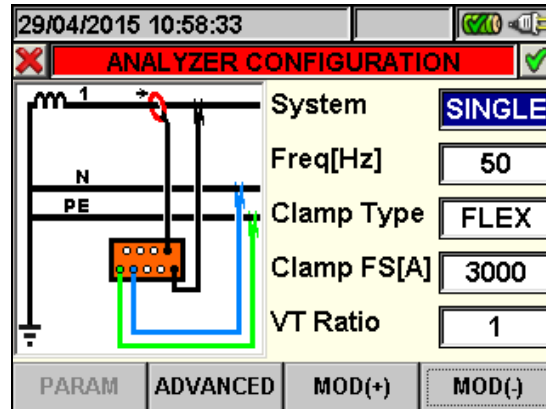

Fig. 50: Analyzer Configuration screen for Single phase system – ENG type

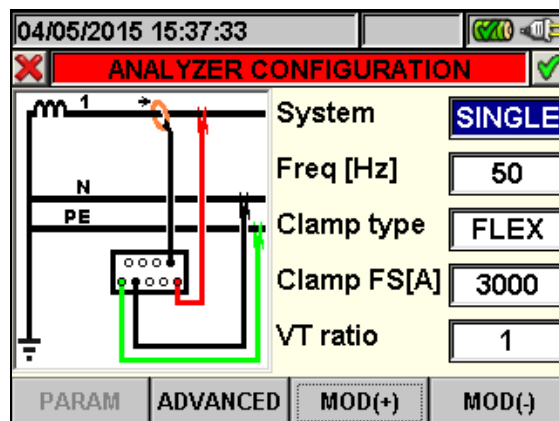

Fig. 51: Analyzer Configuration screen for Single phase system – ENG_UK type

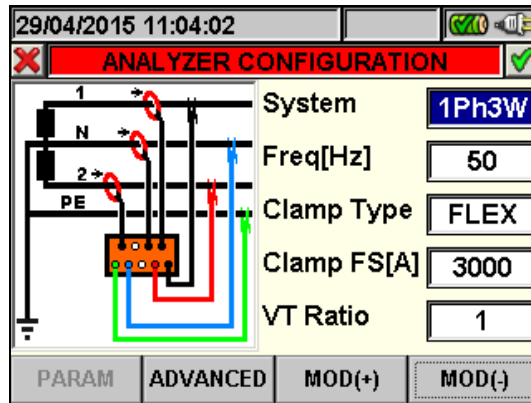

Fig. 52: Analyzer Configuration screen for Two phase system 3-wire 1Ph3W – ENG type

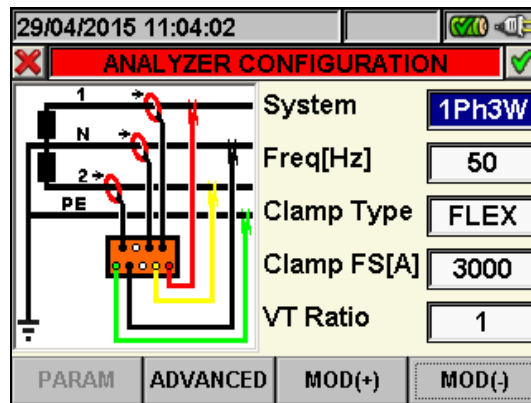

Fig. 53: Analyzer Configuration screen for 2-phase system 3-wire 1Ph3W – ENG_UK type

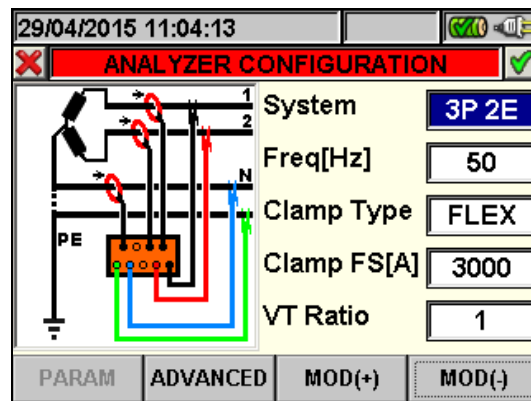

Fig. 54: Analyzer Configuration screen for Two phase system 3-wire 3P 2E – ENG type

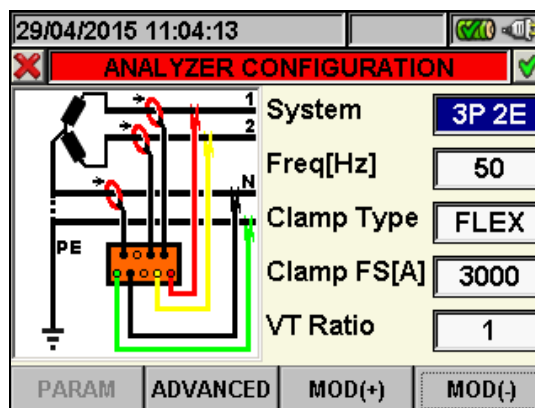

Fig. 55: Analyzer Configuration screen for 2-phase system 3-wire 3P 2E – ENG_UK type

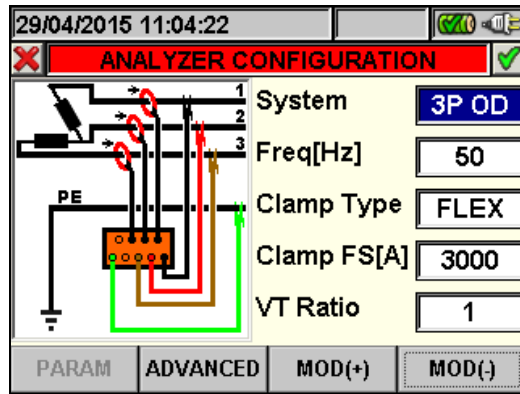

Fig. 56: Analyzer Configuration screen for Three phase system 3-wire 3P OD – ENG type

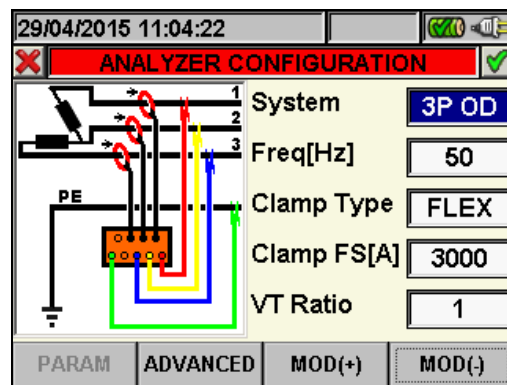

Fig. 57: Analyzer Configuration screen for 3-phase system 3-wire 3P OD – ENG_UK type

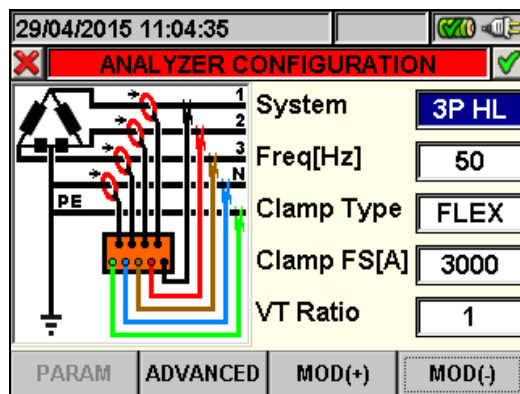

Fig. 58: Analyzer Configuration screen for Three phase system 4-wire 3P HL – ENG type

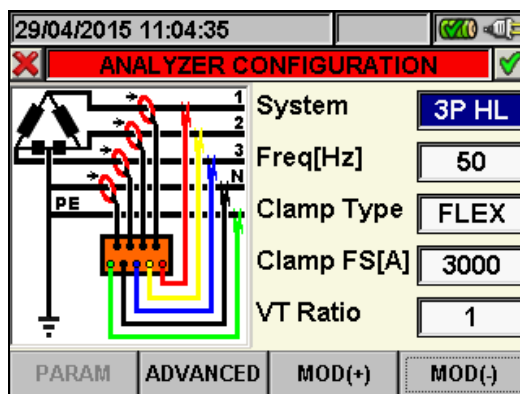

Fig. 59: Analyzer Configuration screen for 3-phase system 4-wire 3P HL – ENG_UK type

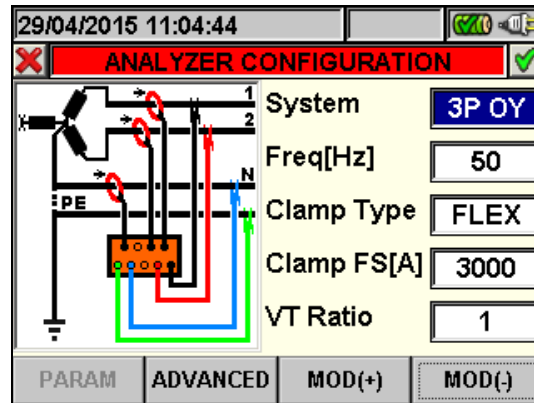

Fig. 60: Analyzer Configuration screen for Two phase system 3-wire 3P OY – ENG type

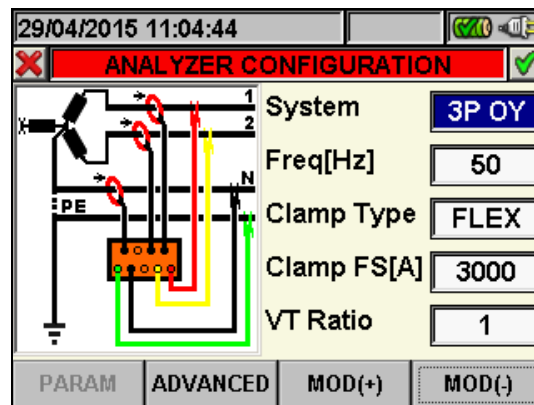





Fig. 61: Analyzer Configuration screen for 2-phase system 3-wire 3P OY – ENG_UK type

1. Move the cursor using arrows keys on field relative to “**System**”, marked with blue background.
2. Use **F3** or **F4** keys (alternatively touch **MOD(+)** o **MOD(-)**) to select the type of system choosing among “4-WIRE”, “3-WIRE”, “ARON” or “SINGLE” options.
3. Press **SAVE** or **ENTER** keys (or the smart icon ) to save the selected option and confirm by “Ok”. This selected parameter will be present also after turning off the meter.
4. Press **ESC** key (or the smart icon ) to quit without saving any modification.

5.3.1.1. Setting system frequency



1. Move the cursor using arrows keys on field relative to “**Freq[Hz]**”, marked with blue background.
2. Use **F3** or **F4** keys (alternatively touch **MOD(+)** o **MOD(-)**) to select the system frequency choosing between **50Hz** or **60Hz** options. This parameter is relevant **ONLY** if the input voltage not permits to recognize the frequency value (for example, only the clamps for the current measurement are connected). In this case the instrument generates an internal synchronism equal to the value of the set frequency.
3. Press **SAVE** or **ENTER** keys (or the smart icon ) to save the selected option and confirm by “Ok”. This selected parameter will be present also after turn off the meter.
4. Press **ESC** key (or the smart icon ) to quit without saving any modification.

5.3.1.2. Setting clamp type

This parameter **must be always set equal to the clamp type used.**



Two types of clamps are available:

- ✓ STD: For Standard clamps or Current Transformer.
- ✓ FLEX: For Flexible clamps

1. Move the cursor using arrows keys on field relative to “**Clamp Type**”, marked with blue background.
2. Use **F3** or **F4** keys (alternatively touch **MOD(+)** o **MOD(-)**) to select clamp type choosing between **STD** or **FLEX** options.
3. Press **SAVE** or **ENTER** keys (or the smart icon ) to save the selected option and confirm by “Ok”. This selected parameter will be present also after turn off the meter.
4. Pressing **ESC** key (or the smart icon ) to quit without saving any modification.



5.3.1.3. Setting full scale of clamps

The value of this parameter **must be always equal to the full scale of the current clamps** used to take the measurement. In case multi-scale clamps are used, the value of this parameter must be equal to the scale selected on the clamps.

1. Move the cursor using arrows keys on field relative to “**Clamps FS [A]**” , marked it with blue background.
2. Use **F3** or **F4** keys (alternatively touch **MOD(+)** o **MOD(-)**) to select the desired full scale. In case of STD clamps any value can be set by using **F3** or **F4** keys (alternatively touch **MOD(+)** o **MOD(-)**). In case of FLEX clamp only **300A** or **3000A** options are possible.
3. Press **SAVE** or **ENTER** keys (or the smart icon ) to save the selected option and confirm by “Ok”. This selected parameter will be present also after turning off the meter.
4. Pressing **ESC** key (or the smart icon ) to quit without saving any modification.

5.3.1.4. Setting VT ratio

The meter can be interfaced also with step-down transformers in the equipment under test. It can display the value of the voltages present on the primary winding of these transformers. To do this it will be necessary to set the value of the transformers' windings ratio.

1. Move the cursor using arrows keys on field relative to “**VT Ratio**” , marked it with blue background.
2. Use **F3** or **F4** keys (alternatively touch **MOD(+)** o **MOD(-)**) for selection of desired value from **1** to **3000**. Leave the default value “**1**” if no voltage transformer is present on installation.
3. Press **SAVE** or **ENTER** keys (or the smart icon ) to save the selected option and confirm by “Ok”. This selected parameter will be present also after turning off the meter.
4. Press **ESC** key (or the smart icon ) to to quit without saving any modification.

5.3.2. Advanced Settings screen

By pressing **F2** key (or touch the “**ADVANCED**” at display) in any screen of “Analyzer Configuration” section, below screen is shown by meter:

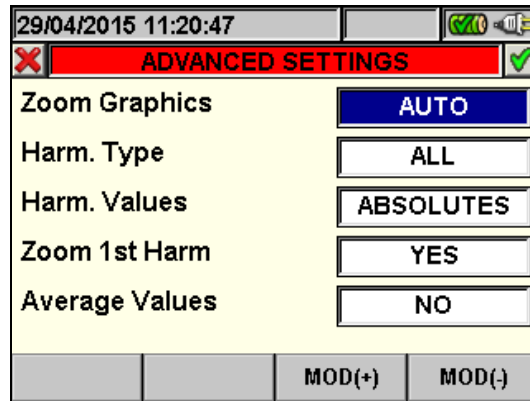



Fig. 62: Advanced Settings screen

In the above screen is possible to select advanced options which have effect in Real Time values screens of meter.



5.3.2.1. Zoom graphics option

This option permits to select a customized full scale **on each phase** of voltage and current waveforms (see Fig. 30, Fig. 31, Fig. 32) in order to better the resolution of readings.

1. Move the cursor using arrows keys on field relative to “**Zoom graphics**”, marked with blue background.
2. Use **F3** or **F4** keys (alternatively touch **MOD(+)** o **MOD(-)**) to select one of below options:
 - ✓ **MANUAL**: define a customized full scale for waveforms’ visualization choosing among the available values. A value included from **2.0A** to **5000kA** it’s set for current and included from **2.0V** to **2000kV** it’s set for voltage.
 - ✓ **AUTO**: the full scale values are automatically modified by the meter
3. Press **SAVE** or **ENTER** keys (or the smart icon ) to save the selected option and confirm by “Ok”. This selected parameter will be present also the turn off of meter.
4. Press **ESC** key (or the smart icon ) to quit without saving any modification

5.3.2.2. Harmonics type option

This option permits to select the type of harmonics which can be shown inside Real Time values section.

1. Move the cursor using arrows keys on field relative to “**Harm. type**” , marked it with blue background.
2. Use **F3** or **F4** keys (alternatively touch **MOD(+)** o **MOD(-)**) to select one of below options:
 - ✓ **ALL**: The meter shows all the harmonics up to the 49st.
 - ✓ **EVEN**: The meter shows all the even harmonics up to the 49st
 - ✓ **ODD**: The meter shows all the odd harmonics up to the 49st
3. Press **SAVE** or **ENTER** keys (or the smart icon ) to save the selected option and confirm by “Ok”. This selected parameter will be present also the turn off of meter.
4. Press **ESC** key (or the smart icon ) to quit without saving any modification.



CAUTION



Not depending on selected harmonics type for the visualization, the meter can performs the recording of all values in any case.

5.3.2.3. Harmonics values option

This option permits to select the value of harmonics which can be shown inside Real Time values' section.

1. Move the cursor using arrows keys on field relative to "**Harm. values**", marked it with blue background.
2. Use **F3** or **F4** keys (alternatively touch **MOD(+)** o **MOD(-)**) to select one of below options:
 - ✓ **ABSOLUTE**: The meter shows the harmonics in absolute values (in V unit for voltages and A unit for currents).
 - ✓ **PERCENTAGE**: The meter shows the harmonics in percentage value respect each fundamental.
3. Press **SAVE** or **ENTER** keys (or the smart icon ) to save the selected option and confirm by "Ok". This selected parameter will be present also the turn off of meter.
4. Press **ESC** key (or the smart icon ) to quit without saving any modification.



CAUTION



Independently of the harmonics value selected for display, the meter can perform the recording of **absolute** values anyway.

5.3.2.4. Zoom with respect to the 1st harmonic option

This option permits to show harmonics graphics with a zoom relative to the first harmonic order (fundamental) or with a zoom relative to the highest amplitude harmonic inside the Real Time values section. Also in this case the aim is to better the final resolution of graphics.



1. Move the cursor using arrows keys on field relative to "**Zoom 1st harm**", marked it with blue background.
2. Use **F3** or **F4** keys (alternatively touch **MOD(+)** o **MOD(-)**) to select one of below options:
 - ✓ **YES**: The meter performs the graphics zoom respect to the first harmonic
 - ✓ **NO**: The meter performs the graphics zoom respect to the highest amplitude harmonics except for the first harmonic. This option is active only if the zoom graphic option (see 5.3.2.1) is set on AUTO mode
3. Press **SAVE** or **ENTER** keys (or the smart icon ) to save the selected option and confirm by "Ok". This selected parameter will be present also the turn off of meter.
4. Press **ESC** key (or the smart icon ) to quit without saving any modification.

5.3.2.5. Average value option

This option, **available for 4-wire systems only**, permits to display the arithmetic average of TRMS values of:

- Phase voltages V1, V2, V3.
- Phase currents I1, I2, I3.
- Active power on each phase P1, P2, P3.

The result is shown on Page 9/9 of numerical TRMS value (see Fig. 27).

1. Move the cursor using arrows keys on field relative to “**Average values**” , marked it with blue background.
2. Use **F3** or **F4** keys (alternatively touch **MOD(+)** o **MOD(-)**) to select one of below options:
 - ✓ **YES**: The meter shows the page 9/9 of average values inside Real Time Values section only for 4-wire systems.
 - ✓ **NO**: The meter does not shows the page 8/8 of average values inside Real Time Values section.
3. Press **SAVE** or **ENTER** keys (or the smart icon ) to save the selected option and confirm by “Ok”. This selected parameter will be present also the turn off of meter.
4. Press **ESC** key (or the smart icon ) to quit without saving any modification.

5.4. RECORDING SETTINGS



Fig. 63: Recording Settings screen selection

In this section the meter permits to define any detail relative to start and stop of recordings, perform parameters selection for recording, the type of analysis to be carried out very easily thanks to “touch screen” display. The use of smart icons and is particularly recommended in this section.

5.4.1. Recording settings screen

This screen is designed with some levels and sub-levels as a typical tree Windows structure in order to reach with extreme details the desired options. After selection of “Recording settings” icon, see the below screen is shown:

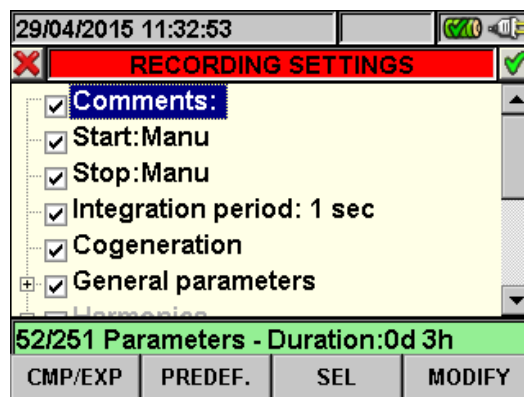

Fig. 64: Recording settings screen

Using up and down arrows keys or touching directly the items at display the selection/disable of internal flags inside check box is possible. Click on check box with “+” symbol to cause an expansion of structure with the opening of a new sub-level inside which new selections are possible. Click on check box with “-” symbol to go back to master level. The displayed selection/disable of parameters is performed in the following way:

- **Grey** text and empty check box → Node completely disabled.
- **Black** text and empty check box → Node partially selected.
- **Black** text and selected check box → Node completely selected.

The bottom bar of display included the below functions, relative to **F1**, **F2**, **F3**, **F4** keys:

- **CLP/EXP**: Used to collapse or expand the sub-levels.
- **PREDEF.**: Used to open the typical configuration section (see § 5.4.12).
- **SEL**: Used to select or disable parameters inside various levels.
- **MODIFY**: Used to perform any parameters modify inside various levels

On the bottom of display the number of selected parameters and the **recording autonomy**, expressed in days and hours, is shown by meter. These s are dynamically updated from meter depending on the parameters selection.

5.4.2. Comments

These option permits to insert a short comment row at display which will compare also in print report downloaded from meter to PC. This comment text is set both using standard TopView software (for any information please refer to software Help on line) and by using the virtual keyboard on meter which is activated by pressing **F4** key (or the **MODIFY** at display). The flag of this option is always active and not disabled.

5.4.2.1. Use of virtual keyboard

With the **Comments**: marked in blue background at display press **F4** key (or the **MODIFY** at display). The below screen is shown at display:

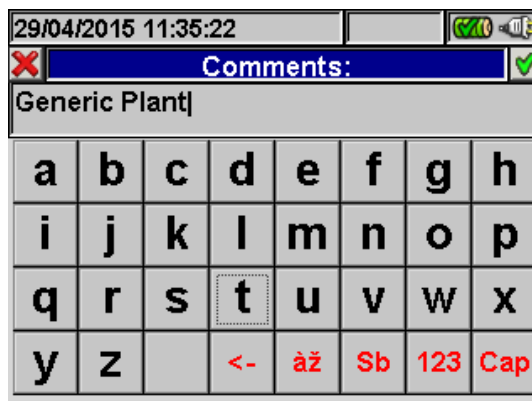

Fig. 65: Virtual keyboard screen

The keys' description of the above keyboard is shown in the below table:

Keys	Description
a, b,c,...z	Standard small letters keyboard for digit comments up to 25 characters
Cap	Capital letters keyboard A÷Z is shown
123	Numerical 0÷9 besides mathematic operation symbols (+,-,*,/,.,=) keyboard is shown
Sb	Special symbols keyboard is shown. By pressing "abc" key to go back to standard small letter keyboard
àž	Special symbols with special stress keyboard are shown. Press "abc" key to go back to standard small letter keyboard
<-	Backspace key to cancel character on the left of the cursor

Table 1: Description of function key of virtual keyboard

5.4.3. Start and Stop

These items permits to define the method to enable and disable the recordings with meter (see § 5.4.13). The possible options are:

- **Manu**: Each recording is enabled/disabled in MANUAL mode by pressing **GO/STOP** key.
- **Auto**: Each recording is enabled/disabled in AUTOMATIC mode, starting from a setting and valid date/hour **by preliminary pressing of GO/STOP** key.

The default configuration is always the MANUAL mode and the flags of these s are not disable. To change from MANUAL mode to AUTO mode (see § 5.4.13.1) performs the below steps:

1. Move the cursor using arrows keys on the field relative to “**Start:Manu**” or “**Stop:Manu**”, marked with blue background.
2. Press **F4** key (alternatively touch the **MODIFY** at display). In the bottom of display a command bar with “Manu” is shown.
3. Press **F3** key (**MOD(+)**) or **F4(MOD(-))** and select “**Auto**” .
4. Use left or right arrows keys to moving on date and hour fields. Using the up arrow key or **F3 (MOD(+))** key to increase the value and the down arrow key or **F4 (MOD(-))** key to decrease the value.
5. Press **SAVE** or **ENTER** keys (or the smart icon ) to save the settings. The Automatic mode and the set date/hour are shown at display.

5.4.4. Integration period

This option permits to set the integration period (see § 10.8.1) which is the time interval between two sequential recordings within the global duration of measurements. The flag of this option is always active and not disabled.

1. Move the cursor using arrows keys on field relative to “**Integration period**” , marked it with blue background.
2. Press **F4** key (alternatively touch the **MODIFY** at display). In the bottom of display a command bar with “Integration Period” is shown.
3. Press **F3** key (**MOD(+)**) or **F4(MOD(-))** or up and down keys to set the desired integration period choosing among the below values: **1s, 5s, 10s, 30s, 1min, 2min, 5min, 10min, 15min, 30min, 60min**.
4. Press **SAVE** key or **ENTER** key (or the smart icon ) to save the settings. The integration period value is shown at display.

5.4.5. Cogenerations

The selection of this , effected both by using up or down arrows keys and directly selecting the flag at display, enters the values of powers and energies generated (co-generation) in the list of recorded parameters (see § 10.7.1).

5.4.6. General Parameters

This option permits the selection of network parameters for recording operation. This level included several sub-level for a detailed selection depending on the type of system on test (see § 5.3.1). Depending on the selection performed, different error screen can be shown by meter. The below situations are possible:

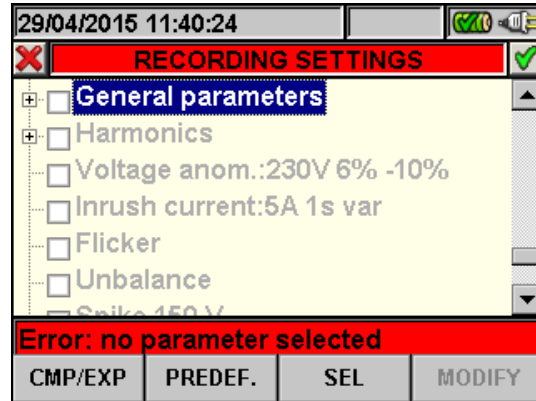

Fig. 66: General Parameters section: no selection

The Fig. 66 shows the situation which the error due to no parameters selection is performed also if the “General Parameters” is selected at display. Please note the text on grey background and the not selected check box. In this situation other type of analysis as Harmonics, Voltage Anomalies, Flicker, etc.. are not possible. Pressing **F3** key (or touch “**SEL**” at display) to exit from this error condition. In this order the flag of “General Parameters” check box it will be selected and the below screen (with black text background) is shown:

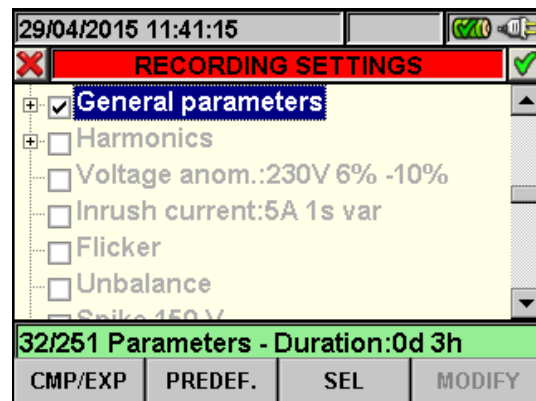

Fig. 67: General Parameters section: selected parameters

In example of the above picture 32 parameters are been selected on total of maximum **251 available** and the correspondent autonomy is shown automatically by meter in this case.



CAUTION

The “General Parameters” check box activated flag, automatically select the main electrical parameters whose number depends on the selected system (Voltages, Currents, Frequency, Power Factor, Active, Reactive, Apparent Powers, Active, Reactive, Apparent Energies). The failure to select “General Parameters” flag automatically do not select the above parameters.

The opposite situation is the error due to a too many selected parameters. In this case the below screen is shown:

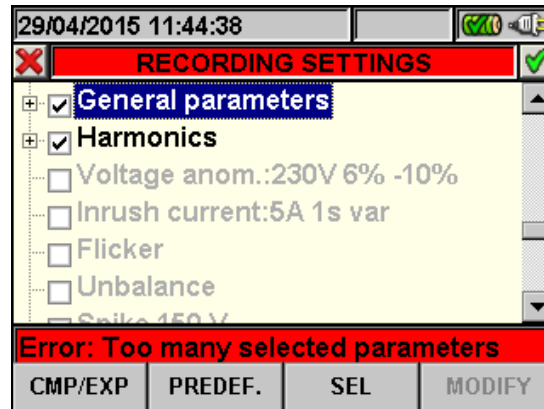

Fig. 68: General Parameters section: too many selected parameters

In the above screen (see Fig. 68) the harmonics' selection brought about too many selected parameters (more than 251). Not select some parameters to quit this situation.

CAUTION

The choose of a electrical for recording often increase the number of selected parameters more than one unit only. In particular:

- Frequency → 1 selected parameter.
- Voltage → from 1 to 7 selected parameter depend on system.
- Current → from 1 to 4 selected parameter depend on system.
- Powers and Energies → from 1 to 8 selected parameter depend on system and Cogenerations.
- Power Factor → from 1 to 8 selected parameter depend on system and Cogeneration.
- Harmonics: THD and DC → from 1 to 8 selected parameter depend on system.
- Harmonics Odd → from 25 to 100 selected parameter depend on system.
- Harmonics Even → from 24 to 96 selected parameter depend on system.
- Voltage Anomalies → no selected parameters.
- Flicker → from 1 to 3 selected parameter depend on system.
- Unbalance → 1 selected parameter.



5.4.6.1. General Parameters: sub-levels description

Press **F1** key (or touch **CLP/EXP** at display) to expand or compress the sub-levels. The parameters inside sub-levels are strictly depending on type of selected system (see § 5.3.1). As an example, below are shown the screens relative to a **three phase 4-wire system**. Similar consideration can be applied to any other selected system.

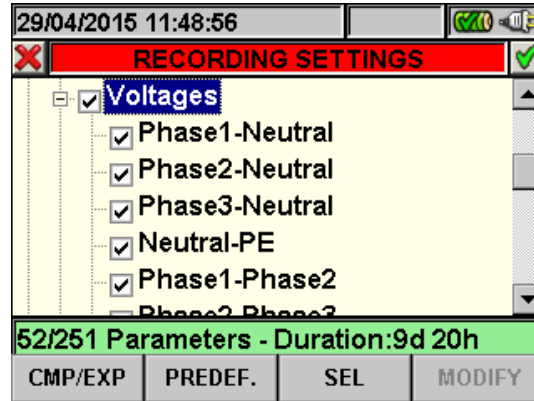



Fig. 69: General Parameters sub-level – Three phase 4-wire system

Each parameter is always selectable **independent** from others. The below parameters can be selected for recording in Single phase systems:

Parameters	Description
Frequency	Frequency of phases L1, L2, L3
Voltages	TRMS voltages L1-N, L2-N, L3-N, N-PE TRMS voltages L1-L2, L2-L3, L3-L1
Currents	TRMS currents L1, L2, L3, Neutral
Active Power & Energy	Active power and energy L1, L2, L3, Total
Reactive Power & Energy	Reactive (inductive or capacitive) power and energy L1, L2, L3, Total
Apparent Power & Energy	Apparent power and energy L1, L2, L3, Total
Power Factor	Power factor L1, L2, L3 Total
CosPhi	Power factor referred to fundamental of voltage and current L1, L2, L3, Total

Table 2: Selectable parameters for Three phase 4-wire system

Press **SAVE** or **ENTER** keys (or the smart icon ) to save each selection and confirm by "Ok". The main screen of Fig. 63 is shown by meter at the end of the operation. Press **ESC** key (or the smart icon ) to quit without saving and back to previous screens.

5.4.6.2. Harmonics: sub-levels description

Press **F1** key (alternatively touch **CLP/EXP** at display) to expand or compress the harmonics sub-levels. The parameters inside sub-levels are strictly depending on type of selected system (see § 5.3.1). Below there are some pictures of different possible situations:

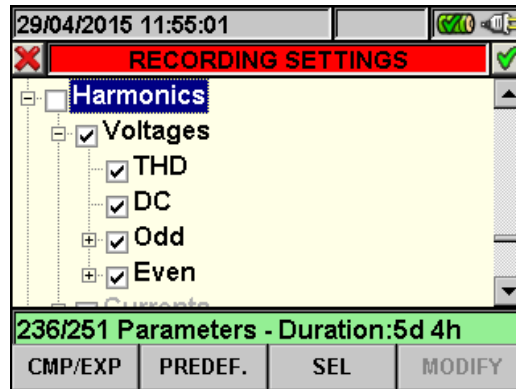

Fig. 70: Harmonics sub-levels: initial parameters selection

Inside Harmonics level there is another sub-level where an accurate selection of harmonic parameters is possible. Move the cursor on “**Odd**” or “**Even**” using arrows key and press **F1** key (or touch **CLP/EXP** at display). The result, referred to Odd harmonics is below shown:

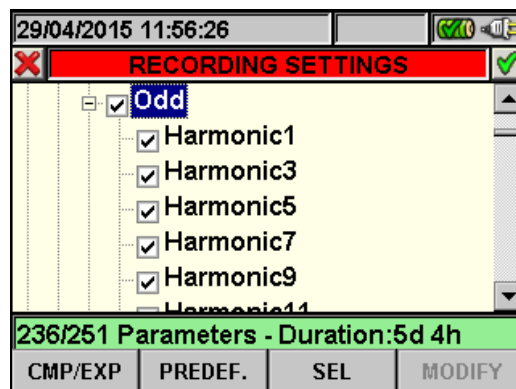



Fig. 71: Harmonics sub-levels: odd harmonics selection

Press **F3** key (alternatively touch **SEL** at display) to select/unselect the desired parameters. The number of selected and recording autonomy are automatically updated from meter (see § 10.2):

Press **SAVE** or **ENTER** keys (or the smart icon ) to save each selection and confirm by “Ok”. The main screen of Fig. 63 is shown by meter at the end of the operation.

Press **ESC** key (or the smart icon ) to quit without saving and back to previous screens.

The selection parameters of harmonic analysis **require** the preliminary selection of voltages or currents inside General Parameter sub-level. The below error screen are shown in these cases:

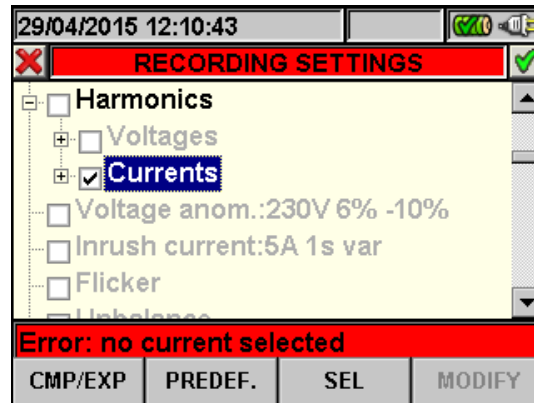

Fig. 72: No selected currents error screen

To solve the error (see Fig. 72) situation of above screen select the “Current” inside “General Parameter” sub-level (see § 5.4.6.1).

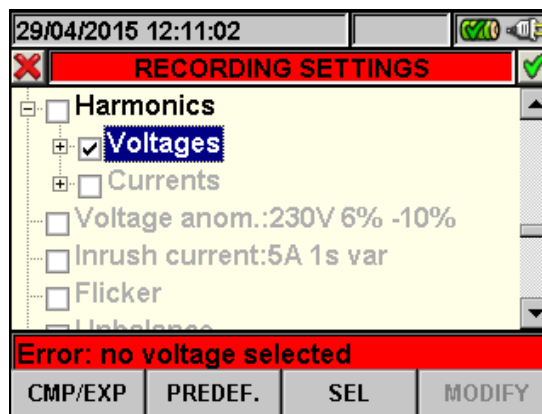

Fig. 73: No selected voltages error screen

To solve the error (see Fig. 73 situation of above screen select the “**Voltages**” inside “General Parameter” sub-level (see § 5.4.6.1).

5.4.7. Voltage Anomalies

This option permits to set the control parameters relative to voltage anomalies (sags, swell, supply breaks – see § 10.1) recording which is completely **independent** from periodic analysis (regulated by integration period). The below screen is shown by meter:

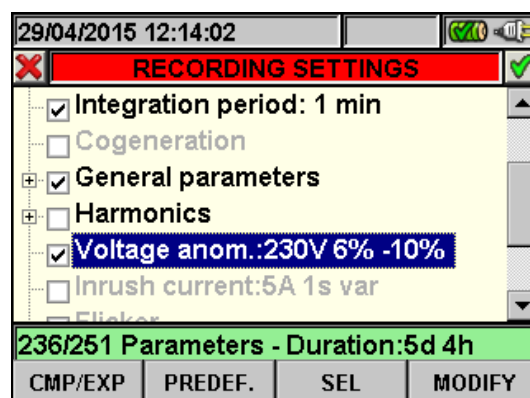

Fig. 74: Voltage Anomalies selection screen

Press **F4** key (alternatively touch **MODIFY** at display) for setting the below voltage anomalies parameters:

- Reference nominal voltage **Vref** depending on the type of considered system. In particular **Vref = VP-N** (Single phase and three phase 4-wire systems), **Vref = VP-P** (three phase 3-wire and ARON systems)
- The higher threshold percentage of reference nominal voltage, selectable from **1%** to **30%** for voltage swell detection.
- The lower threshold percentage of reference nominal voltage, selectable from **1%** to **30%** for voltage sags or breaks detection.

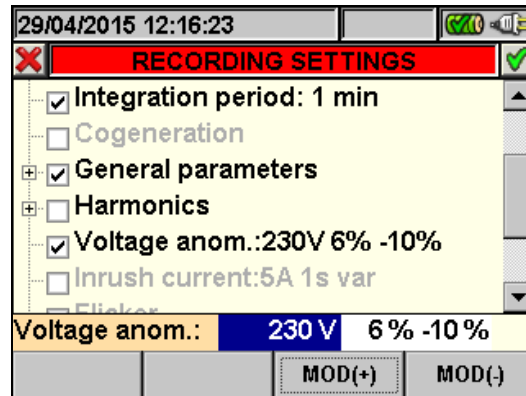



Fig. 75: Voltage Anomalies screen - setting control parameters

1. Move the cursor using arrows keys on field relative to “**Voltage Anom.**”, marked it with blue background.
2. Use up or down arrow keys or press **F3** or **F4** keys (alternatively touch the **MOD(+)** or **MOD(-)** s at display) to setting the correspondent value. Pressing and holding of these keys permits a rapid values setting, while the single pressure increase or decrease on only unit the value. Use left or right arrow keys to move on various fields.
3. Press **SAVE** or **ENTER** keys (or the smart icon ) to save each performed setting.

CAUTION



The nominal reference value should be set depending on the type of considered system on test and the measured voltage. A message “**Wrong Vref voltage anomalies**” at the recording start is shown by meter which do not permits the recording operation due to this wrong configuration (e.g.: 4-wire system and Vref = 400V). Set the correct value in this case.

5.4.8. Inrush current (only PQA82x)

This option permits to set the control parameters relative to recording of inrush current events (see § 10.3) which is completely **independent** from periodic analysis (regulated by integration period). The below screen is shown by meter:

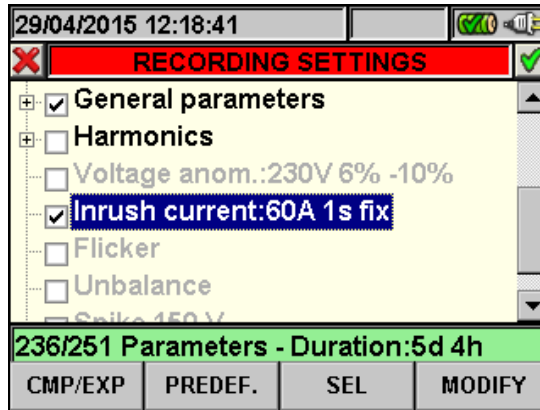

Fig. 76: Inrush currents selection screen

Press **F4** key (alternatively touch **MODIFY** at display) to set the below parameters for recording of inrush currents:

- The value of current threshold which is correspondent to detection and recording of inrush current event from meter. This value cannot exceeded the full scale which is selected for the clamp type used for current measurements (see § 5.3.1.3).
- The value of the inrush current detection time interval expressed in seconds. Possible values which can be set are **1s**, **2s**, **3s** and **4s**.
- The detection type of inrush currents events. The **fix** mode (the event is detected whenever the input current value is over the set threshold) or **var** mode (the event is detected if the difference between two instantaneous values in a half period exceed the set threshold) are possible.

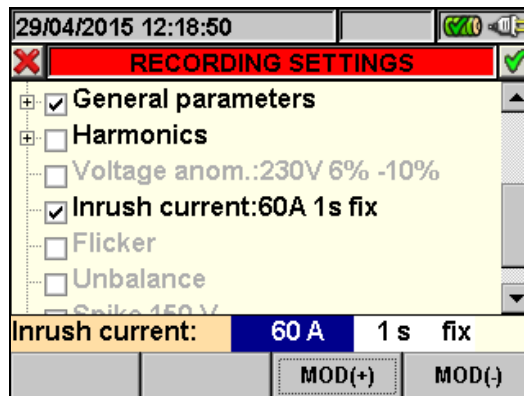

Fig. 77: Inrush current screen - setting control parameters

1. Move the cursor using arrows keys on field relative to **"Inrush current"** , marked it with blue background.
2. Use up or down arrow keys or press **F3** or **F4** keys (alternatively touch the **MOD(+)** or **MOD(-)** s at display) to set the correspondent value. Pressing and holding these keys permits a rapid values setting, while the single pressure increases or decreases the value by one single unit. Use left or right arrow keys to move on various fields.
3. Press **SAVE** or **ENTER** keys (or the smart icon) to save each performed setting.

5.4.9. Flicker (only PQA82x)

This option permits to set control parameters relative to flicker value recordings on the input voltages in compliance to IEC/EN61000-4-15 standard (see § 10.4). In particular the below parameters are shown by meter:

- Pst1' = short term severity at 1 min.
- Pst = short term severity for all recording duration.
- Plt = long term severity for all recording duration.

The below screen is shown:

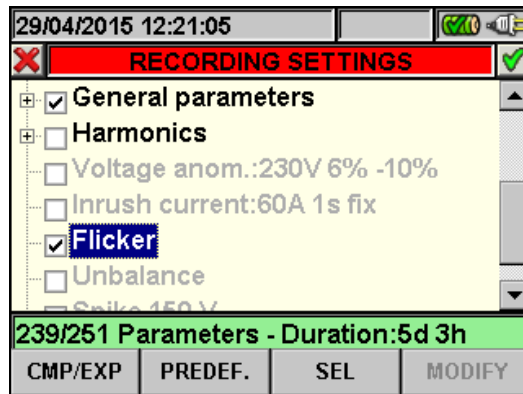

Fig. 78: Flicker setting screen

For flicker recording at least one voltage selection and a correct integration period are necessary conditions. In particular if no voltage are selected the below error screen is shown by meter:

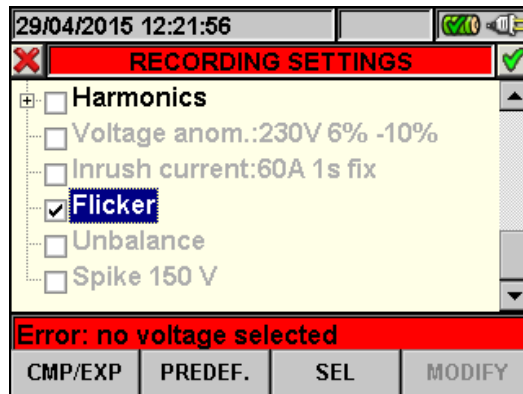

Fig. 79: Flicker setting screen - no selected voltage

See the § 5.4.6 to exit from this error situation. In case of integration period setting value **less of 1 minute or higher to 15 minutes** the below error screen is shown by meter:

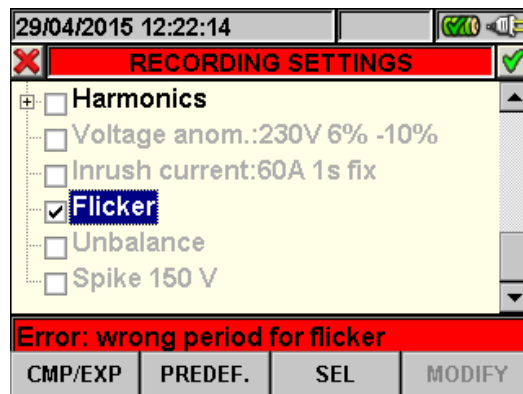



Fig. 80: Flicker setting screen - wrong period for flicker

See the § 5.4.4 to exit from this error situation.

Press **SAVE** or **ENTER** keys (or the smart icon ) to save each selection and confirm by “Ok” . The main screen of Fig. 63 is shown by meter at the end of the operation.
 Press **ESC** key (or the smart icon ) to quit without saving and go back to previous screens.

5.4.10. Unbalance

The selection of this option include on selected parameters list for recording the value of **NEG%** and **ZERO%** s which are index of unbalance of input voltage signal respective to negative tern and zero term (see § 10.5). “Unbalance” is not shown for single phase systems.

5.4.11. Spike (only PQA824)

This option permits to set the control parameters relative to recording of voltage fast transients (spike) events (see § 10.6) with 5 μ s resolution which is completely **independent** from periodic analysis (regulated by integration period). The below screen is shown by meter:

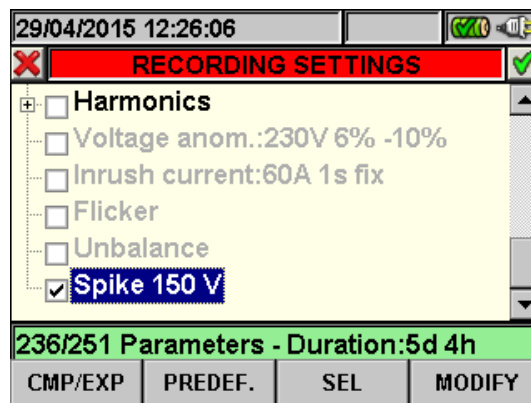

Fig. 81: Spike setting screen

Press **F4** key (alternatively touch **MODIFY** at display) for setting the parameter for detection and recording of voltage spikes. In particular is possible to set:

- The value of voltage threshold to detection and recording the voltage spike event from meter. This value s selectable from **100V** and **5000V** value.

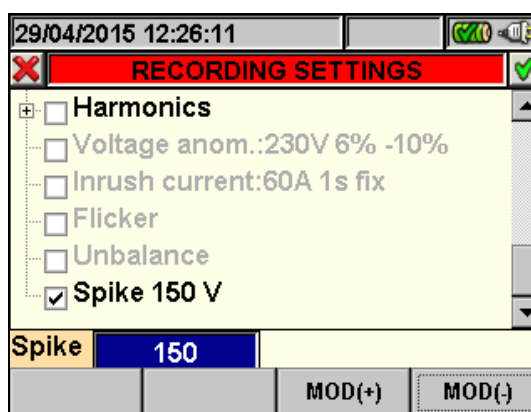



Fig. 82: Spike screen - setting control parameter

1. Move the cursor using arrows keys on field relative to “**Spike**” , marked it with blue background.
2. Use up or down arrow keys or press **F3** or **F4** keys (alternatively touch the **MOD(+)** or **MOD(-)** s at display) to set the correspondent value. Pressing and holding of these keys permit a rapid values setting, while the single pressure increase or decrease on only unit the value.
3. Press **SAVE** or **ENTER** keys (or the smart icon ) to save each performed setting.

5.4.12. Predefined configurations

In order to make the recording start easier the meter includes 5 selectable predefined configurations which describe typical situation in electrical installations, besides a “Default” configuration which defines the initial settings from the factory. The meter also permits to define up to **14 free configuration** which can be customized, saved and recalled by user at any time. The selection of one of these configurations automatically sets **only the necessary** parameters for recording operation under that circumstance. The predefined configurations are:

1. **DEFAULT:** Setting parameters of default configuration from the exit of meter by factory.
2. **EN50160:** Setting parameters for networks quality recording (voltage anomalies, harmonics, flicker, unbalance and spikes) in compliance to EN50160 standard (see § 10.2.2) (only PQA82x)
3. **VOLTAGE ANOMALIES:** Setting parameters for voltage anomalies recording only (sags, swells, breaks – see § 10.1).
4. **HARMONICS:** Setting parameters for voltages and currents harmonic analysis (see § 10.2).
5. **INRUSH:** Setting parameters inrush current events detection (only PQA82x)
6. **POWER & ENERGY:** Setting parameters for power and energy measures (see § 10.7).

Pressing **F2** key (or touch **PREDEF.** at display) in any “Recording Settings” screen. The meter show the below screen:

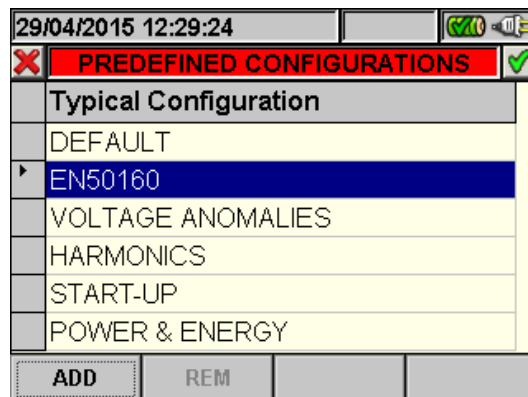



Fig. 83: Typical configuration screen

Select the desired typical configuration using up or down arrow keys or touch display. Press **SAVE** or **ENTER** keys (or the smart icon ) to save the desired selection. The warning message “**Change recording setting?**” is shown by meter. Press “Ok” to confirm. The meter automatically sets the parameters and updated the recording autonomy at display.

To add a predefined customized configuration press the **F1** key (or the **ADD** at display). The warning message “**Add actual configuration**” is shown by meter. Press “Ok” to confirm and activate automatically the virtual keyboard (see § 5.4.2.1) where it’s possible to define and save the configuration name by user. At the end of these operations the following screen is shown by meter:

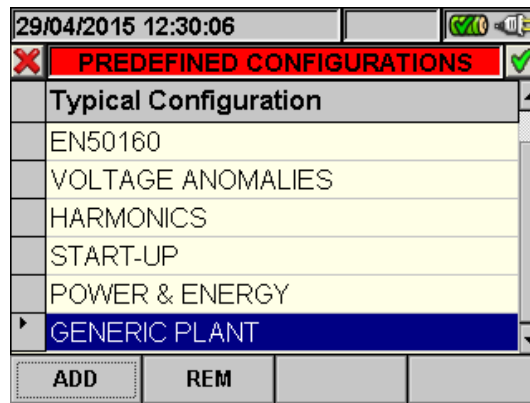



Fig. 84: Typical customized configuration screen

In the example of Fig. 84 the typical customized configuration called “GENERIC PLANT” was defined and can be loaded by pressing the **SAVE** or **ENTER** keys (or the smart icon ). This configuration can be removed in any time by pressing **F2** key (or the **REM** at display). The warning message “**Delete selected configuration?**” is shown by meter. Press “Ok” to complete the operation. Please note that the 5 predefined configuration and the DEFAULT configuration **cannot** be removable by user.

Press **ESC** (or the smart icon ) to quit without saving any modify. Below the selected parameters for each of predefined configuration are shown:

EN50160 (only PQA82x)			
GENERAL MENU	PARAMETER	SETTINGS	SYSTEM
Analyzer Settings	System	Not modified	Each system
	Freq[Hz]		
	Clamp Type		
	FS Clamp[A]		
	VT Ratio		
Analyzer Settings - Advanced	Zoom Graphics		
	Harm. Type		
	Harm. Values		
	Zoom 1st Harm.		
	Average Values		
Recording Settings	Comments	EN50160	Each system
	Start	Not modified	
	Stop	Not modified	
	Integration period	10min	
	Cogeneration	OFF	
	General Parameters	V1N, Hz	Single phase
		V12,V23, V31, Hz	ARON
		V1-PE, V2-PE, V3-PE V12, V23, V31, Hz	3-wire
		V1N, V2N, V3N, Average (if activated), Hz	4-wire
	Voltage harmonics	THD, DC, h1, h2, h3...h25	Each system
	Current harmonics	OFF	
	Voltage anomalies	ON	
	Ref. Voltage anomalies	230V	Single, 4-wire
		400V	3-wire, ARON
	Up threshold anomalies	+6%	Each system
	Low threshold anomalies	-10%	
	Inrush current (only PQA82x)	OFF	
	Flicker	ON	Single phase
	Unbalance	Not available	
		ON	
Spike (only PQA824)	ON (150V)	Each system	

Table 3: Selected parameters of EN50160 configuration

VOLTAGE ANOMALIES			
GENERAL MENU	PARAMETER	SETTINGS	SYSTEM
Analyzer Settings	System	Not modified	Each system
	Freq[Hz]		
	Clamp Type		
	FS Clamp[A]		
	VT Ratio		
Analyzer Settings - Advanced	Zoom Graphics		
	Harm. Type		
	Harm. Values		
	Zoom 1st Harm.		
	Average Values		
Recording Settings	Comments	VOLTAGE ANOMALIES	Each system
	Start	Not modified	
	Stop	Not modified	
	Integration period	1min	
	Cogeneration	OFF	
	General Parameters	V1N, VN-PE, Hz	Single phase
		V12, V23, V31, Hz	3-wire, ARON
		V1N, V2N, V3N, VN-PE, Average (if activated), Hz	4-wire
	Voltage harmonics	OFF	Each system
	Current harmonics	OFF	
	Voltage anomalies	ON	
	Ref. Voltage anomalies	230V	Single, 4-wire
		400V	3-wire, ARON
	Up threshold anomalies	+6%	Each system
	Low threshold anomalies	-10%	
	Inrush current (only PQA82x)	OFF	
	Flicker	OFF	
	Unbalance	Not available	Single phase
ON		3/4-wire, ARON	
Spike (only PQA824)	ON (150V)	Each system	

Table 4: Selected parameters of VOLTAGE ANOMALIES configuration

HARMONICS			
GENERAL MENU	PARAMETER	SETTINGS	SYSTEM
Analyzer Settings	System	Not modified	Each system
	Freq[Hz]		
	Clamp Type		
	FS Clamp[A]		
	VT Ratio		
Analyzer Settings - Advanced	Zoom Graphics		
	Harm. Type		
	Harm. Values		
	Zoom 1st Harm.		
	Average Values		
Recording Settings	Comments	HARMONICS	Each system
	Start	Not modified	
	Stop	Not modified	
	Integration period	10min	
	Cogeneration	OFF	
	General Parameters	V1N, VN-PE, I1, Hz	Single phase
		V1-PE, V2-PE, V3-PE, V12, V23, V31 I1, I2, I3, Hz	3-wire
		V12, V23, V31 I1, I2, I3, Hz	ARON
		V1N, V2N, V3N, VN-PE, I1, I2, I3, IN (only PQA82x), Hz	4-wire
	Voltage harmonics	THD, DC, h1, h2, h3...h25	Each system
	Current harmonics	THD, DC, h1, h2, h3...h25	
	Voltage anomalies	OFF	
	Ref. Voltage anomalies	OFF	Single, 4-wire
		OFF	3-wire, ARON
	Up threshold anomalies	OFF	Each system
	Low threshold anomalies	OFF	
	Inrush current (only PQA82x)	OFF	
Flicker	OFF		
Unbalance	Not available	Single phase	
	OFF	3/4-wire, ARON	
Spike (only PQA824)	OFF	Each system	

Table 5: Selected parameters of HARMONICS configuration

INRUSH				
GENERAL MENU	PARAMETER	SETTINGS	SYSTEM	
Analyzer Settings	System	Not modified	Each system	
	Freq[Hz]			
	Clamp Type			
	FS Clamp[A]			
	VT Ratio			
Analyzer Settings Advanced	Zoom Graphics			
	Harm. Type			
	Harm. Values			
	Zoom 1st Harm.			
	Average Values			
Recording Settings	Comments	INRUSH	Each system	
	Start	Not modified		
	Stop	Not modified		
	Integration period	1s		
	Cogeneration	OFF		
	General Parameters		V1N, VN-PE, I1, Hz	Single phase
			V1-PE, V2-PE, V3-PE, V12, V23, V31 I1, I2, I3, Hz	3-wire
			V12, V23, V31 I1, I2, I3, Hz	ARON
			V1N, V2N, V3N, VN-PE I1, I2, I3, IN (only PQA82x), Hz	4-wire
			P1, Q1i, Q1c, S1, Pf1, Cosphi1, Ea1, Eri1, Erc1	Single phase
			Pt, P1, P2, P3, Qti, Qti1, Qti2, Qti3, Qtc, Qtc1, Qtc2, Qtc3, St, S1, S2, S3, Pft, Pf1, Pf2, Pf3, Cosphit, Cosphi1, Cosphi2, Cosphi3, Eat, Eat1, Eat2, Eat3, Erit, Eri1, Eri2, Eri3, Erct, Erc1, Erc2, Erc3	3-wire, 4-wire
			Pt, P12, P32, Qti, Q12i, Q32i, Qtc, Q12c, Q32c, St, S12, S32, Pft, Pf12, Pf32, Cospht, Cosphi12, Cosphi32, Eat, Ea12, Ea32, Erit, Eri12, Eri32, Erct, Erc12, Erc32	ARON
	Voltage harmonics	THD, DC, h1, h2, h3...h15	Each system	
	Current harmonics	THD, DC, h1, h2, h3...h15		
	Voltage anomalies	ON		
	Ref. Voltage anomalies		230V	Single, 4-wire
			400V	3-wire, ARON
	Up threshold anomalies		+6%	Each system
	Low threshold anomalies		-10%	
	Inrush current (only PQA82x)		ON (10A, 1s, var)	
Flicker		OFF		
Unbalance		Not available	Single phase	
		ON	3/4-wire, ARON	
Spike (only PQA824)		OFF	Each system	

Table 6: Selected parameters of START-UP configuration

POWER & ENERGY				
GENERAL MENU	PARAMETER	SETTINGS	SYSTEM	
Analyzer Settings	System	Not modified	Each system	
	Freq[Hz]			
	Clamp Type			
	FS Clamp[A]			
	VT Ratio			
Analyzer Settings Advanced	Zoom Graphics			
	Harm. Type			
	Harm. Values			
	Zoom 1st Harm.			
	Average Values			
Recording Settings	Comments	POWER & ENERGY	Each system	
	Start	Not modified		
	Stop	Not modified		
	Integration period	15min		
	Cogeneration	ON		
	General Parameters		V1N, I1	Single phase
			V1-PE, V2-PE, V3-PE, V12, V23, V31, I1, I2, I3, Hz	3-wire
			V12, V23, V31, I1, I2, I3, Hz	ARON
			V1N, V2N, V3N, V12, V23, V31, I1, I2, I3, IN (only PQA82x), Hz	4-wire
			P1, Q1i, Q1c, S1, Pf1, Cosphi1, Ea1, Eri1, Erc1	Single phase
			Pt, P1, P2, P3, Qti, Qti1, Qti2, Qti3, Qtc, Qtc1, Qtc2, Qtc3, St, S1, S2, S3, Pft, Pf1, Pf2, Pf3, Cosphit, Cosphi1, Cosphi2, Cosphi3, Eat, Eat1, Eat2, Eat3, Erit, Eri1, Eri2, Eri3, Erct, Erc1, Erc2, Erc3	3-wire, 4-wire
			Pt, P12, P32, Qti, Q12i, Q32i, Qtc, Q12c, Q32c, St, S12, S32, Pft, Pf12, Pf32, Cospht, Cosphi12, Cosphi32, Eat, Ea12, Ea32, Erit, Eri12, Eri32, Erct, Erc12, Erc32	ARON
	Voltage harmonics	OFF	Each system	
	Current harmonics	OFF		
	Voltage anomalies	OFF		
	Ref. Voltage anomalies	OFF	Single, 4-wire	
		OFF	3-wire, ARON	
	Up threshold anomalies	OFF	Each system	
	Low threshold anomalies	OFF		
	Inrush current (only PQA82x)	OFF		
Flicker	OFF			
Unbalance	Not available	Single phase		
	OFF	3/4-wire, ARON		
Spike (only PQA824)	OFF	Each system		

Table 7: Selected parameters of POWER & ENERGY configuration

DEFAULT CONFIGURATION			
GENERAL MENU	PARAMETER	SETTINGS	
Analyzer Settings	System	4-wire	
	Freq[Hz]	50	
	Clamp Type	FLEX	
	FS Clamp[A]	3000	
	VT Ratio	1	
Analyzer Settings Advanced	Zoom Graphics	AUTO	
	Harm. Type	ALL	
	Harm. Values	ABSOLUTES	
	Zoom 1st Harm.	YES	
	Average Values	NO	
Recording Settings	Comments	DEFAULT	
	Start	Manu	
	Stop	Manu	
	Integration period	15min	
	Cogeneration	OFF	
	General Parameters	V1N,V2N,V3N,VN-PE,V12,V23,V31, I1, I2, I3, IN (only PQA82x), Hz	
		Pt, P1,P2,P3, Qti, Qi1, Qi2, Qi3, Qtc, Qc1, Qc2, Qc3, St, S1, S2, S3, Pft, Pft1, Pft2, Pft3, Cosphi, Cosphi1, Cosphi2, Cosphi3, Eat, Ea1, Ea2, Ea3, Erit, Eri1, Eri2, Eri3, Erct, Erc1, Erc2, Erc3	
	Voltage harmonics	THD, DC, h1, h2, h3...h11	
	Current harmonics	THD, DC, h1, h2, h3...h11	
	Voltage anomalies	ON	
	Ref. Voltage anomalies	230V	
	Up threshold anomalies	+6%	
	Down threshold anomalies	-10%	
	Inrush current (only PQA82x)	OFF	
	Flicker	OFF	
Unbalance	ON		
Spike (only PQA824)	ON (150V)		

Table 8: Parameters of default configuration

CAUTION



The DEFAULT configuration defines the selection of parameters on meter from the factory, as shown in Table 8. Each new modification performed and saved by the user on “Analyser Settings” section replaces this configuration with new selection which can be different from the default standard.

5.4.13. Start a recording

The meter is designed to start a recording in MANUAL or AUTOMATIC mode (see § 5.4.3) by pressing of **GO/STOP** key. A recording operation can be started exclusively under the following screens:

- **MENU GENERAL** (with any selected icon).
- **Real Time Values** (in any internal screen).

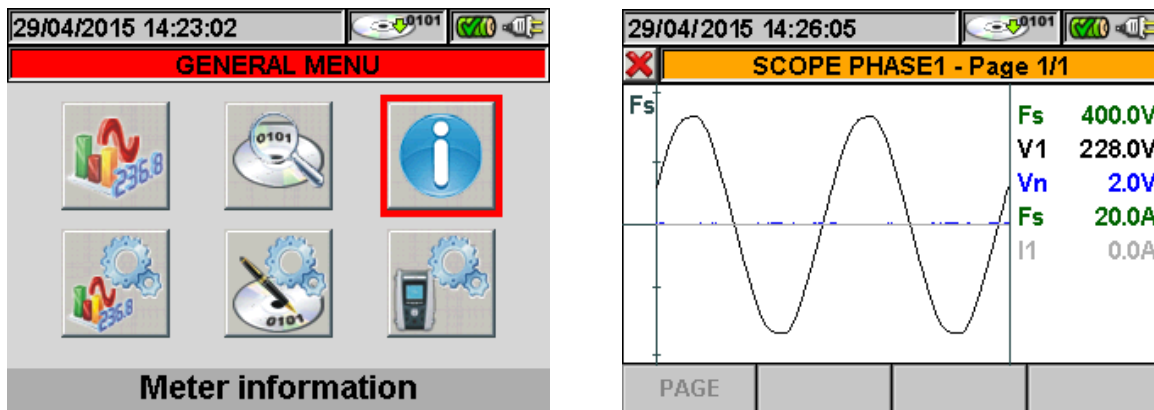



Fig. 85: Example of screens for recording starting

Before starting a recording press **ESC** key (or the smart icon ) until you get a picture as shown in Fig. 85. This operation can be performed in the below ways:

- ✓ **MANUAL:** Recording will start at the following minute after pressing **GO/STOP** key.
- ✓ **AUTO:** After the (**necessary**) pressing of **GO/STOP** key the meter stands-by until the set Date/Hour (see § 5.4.3) and then start automatically the recording.

The waiting and recording run status are marked by meter with dedicated icons which are present on the top right of display, as shown in below picture:



Fig. 86: Meter waiting for recording



Fig. 87: Meter in recording run

Press again **GO/STOP** key to stop the recording run in any time. The icon shown in Fig. 87 disappear.

CAUTION



For recordings **ALWAYS** use the **external power supply** even though the instrument allows the operator to perform a recording using internal batteries.

After starting a recording a preliminary real time evaluation about the situation on electrical installation it's important in order to perform a correct settings, using the predefined configurations (see § 5.4.12) if necessary.

The below warning message can be shown by meter after pressing of **GO/STOP** key:

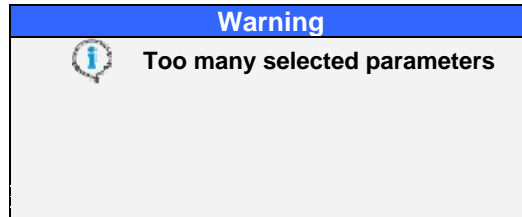

Fig. 88: Warning message of too many selected parameters

In this case of too many parameters were selected it is necessary to disable them inside "Recordings Settings" section in order to start a correct recording.

After pressing **GO/STOP** key a possible warning message window is shown by meter. Inside this window message the internal item can be different as for type and number. This warning message, which does not block the recording start, is important for user to correct possible errors performed during meter's setting:

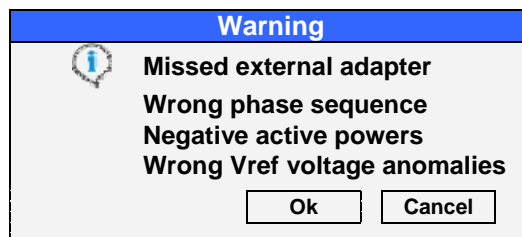

Fig. 89: Warning message errors screen

Below the meaning of the above s of warning windows screen:

Type of error	Description
<i>Missed external adapter</i>	Connect the external adapter to meter before start recording
<i>Wrong phase sequence</i>	The value of " SEQ " parameter in Real Time Values section (see § 5.2.1) is different from the correct " 123 ". Check the phase sequence value of V1, V2, V3 voltages
<i>Negative active powers</i>	One or more values of P1, P2, P3 Active Powers is negative (see § 5.2.1). Reversing if necessary the transducer clamps of 180 degrees on phase cables in order to obtain always positive values (except cogeneration cases)
<i>Wrong Vref voltage anomalies</i>	The nominal reference voltage value for voltage anomalies is not compliance to the type of selected system (see § 5.4.7)

Table 9: Description of errors before start a recording

Depending on the type and number of errors, the necessary modifications of setting parameters should be performed. Press **GO/STOP** key again to start recording and verify the possible residual error on window message.

Confirm with **ENTER** or press “Ok” or “Cancel” keys to close the warning window message and start the recording by pressing **GO/STOP** key anyway.

As the default value of the integration periods is set at **15min** (see § 10.8.1) the meter will store data in the temporary memory for this time. Afterwards the meter will process the results saved in the temporary memory and will save the first series of values in the definitive memory. Therefore, if an integration period of 15 minutes has been set, the recording will continue for about 15 minutes before producing a series of recorded values



CAUTION

Let the meter record for **at least** one integration period in order to save a valid value. If the recording is interrupted before the selected integration period has completely elapsed the data stored in the temporary memory will not be processed and the corresponding series of values won't be transferred to the definitive memory.

5.4.13.1. Automatic start of recording

To start a recording under automatic mode a preliminary definition of a correct starting Date/Hour, compatible with system date, is needed inside “Recorder Settings” section (see § 5.4). The below screen is shown:

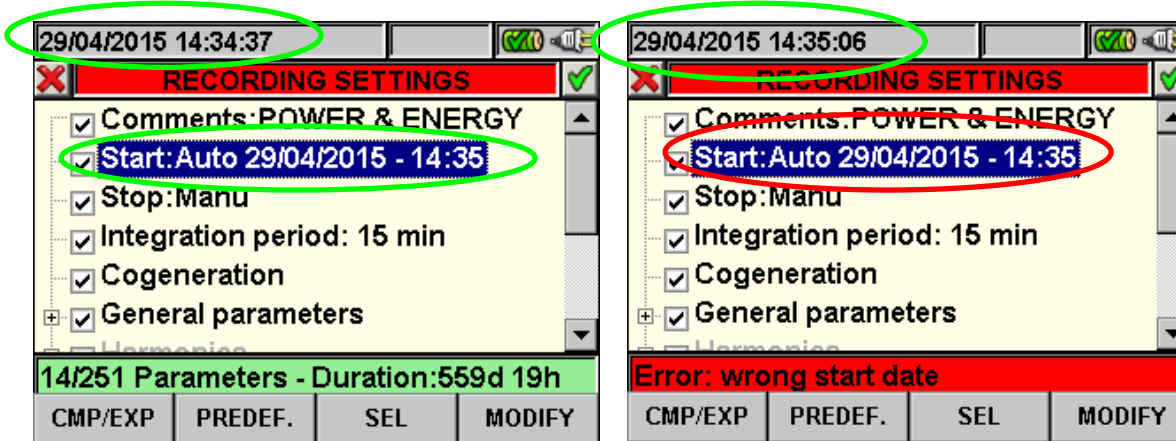

Fig. 90: Correct Date/Hour

Fig. 91: Wrong Date/Hour

1. Move the cursor using arrows keys on field relative to “Start” (and or the “Stop”), marked them with blue background.
2. Press **F4** key (alternatively touch the **MODIFY** at display). In the bottom of display a command bar with “Manu” is shown. Press **F3** key (**MOD(+)**) or **F4(MOD(-))** and select “Auto” .Use left or right arrows keys to move on date and hour fields. Using the up arrow key or **F3 (MOD(+))** key to increase the value and the down arrow key or **F4 (MOD(-))** key to decrease the value. Set a correct Date/Hour as shown in Fig. 90.
3. Press **SAVE** or **ENTER** keys (or smart icon) to saving the settings. The screen of Fig. 91 is shown if a wrong Date/Hour is set. Under this condition the **SAVE** key does not have any effect. Repeat the steps 2 and 3 and set corrects values before pressing **SAVE** key again.

5.4.14. During a recording

After a recording is running, a real time check of parameters's values and internal status is shown by meter.



Fig. 92: Recording Results screen - Recording running

1. Select "Recording Results" in GENERAL MENU.
2. Pressing **ENTER** or touch the correspondent icon at display. The below screen is shown:

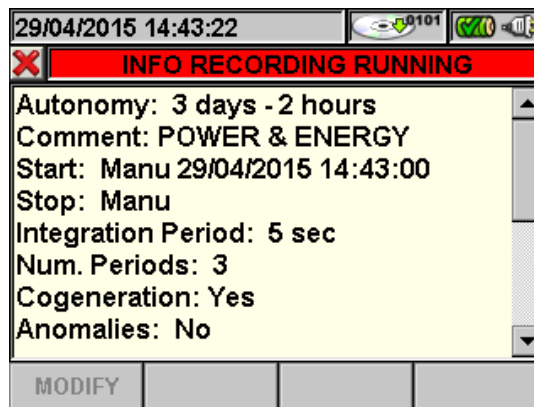

Fig. 93: Info recording running screen

3. The below information are included in the above screen:
 - Recording autonomy, in Days/Hours, of meter with the currents selections performed.
 - Comments included in the relative section (see § 5.4.2).
 - Type of recording start.
 - Type of recording stop.
 - Real time information about integration period performed by meter.
 - Enable of cogeneration.
 - Number of recorded voltage anomalies.
 - Enable or disable of Flicker (only PQA82x)
 - Enable or disable of Inrush Current (only PQA82x).
 - Detection of voltage Spikes (only PQA824).
 - Type of selected system.
 - Type of used clamp.
 - Full scale of used clamp.
 - Ratio of eventual external VT used.
4. Pressing **ESC** key (or the smart icon) to quit from the above screen.

Each recording running is stopped and results are **automatically** saved by meter by pressing of **GO/STOP** key or as soon as the date/hour of automatic stop is reached.

CAUTION



- The only “Real Time Values” section is available during a recording running. The message “*Menu not available in recording*” is shown by meter if any section is selected. Stop recording pressing **GO/STOP** key before select any section.
- **ON/OFF** key is disabled during a recording running. The message “*Recording running. Not available function*” is shown by meter. Stop recording pressing **GO/STOP** key before pressing this key.

5.5. SAVED DATA MANAGEMENT SECTION



Fig. 94: GENERAL MENU - Saved Data Management

The “Saved Data Management” section allows the user to check the content of the internal memory after recording, to delete previous recordings and possibly to copy a recording (one at a time) on an external USB Pen Driver connected to the instrument. By pressing the **ENTER** key or selecting the icon on the display, the instrument shows the following screen:

N.	Type	Time 1	Time 2
1	Snapshot	08/01/2008	01:19:17
2	Snapshot	08/01/2008	01:21:06
3	Snapshot	08/01/2008	01:22:09
4	Snapshot	08/01/2008	01:22:42
5	Rec	30/03/2007	01/04/2007
6	Rec	30/03/2007	30/03/2007

Fig. 95: Saved data

The instrument performs the following types of recordings:

- **Reg** type: Recordings performed and saved **automatically**, both in manual and automatic mode, of each analysis (Periodics, Harmonics, Voltage Anomalies, Flickers, etc...) by pressing the **GO/STOP** key.
- **Istant** type: Instant samplings of the values displayed (numerical, waveforms, harmonics, etc...) performed by pressing the **SAVE** key.

Each line of the “Saved Data Management” screen includes, further to the type of data saved in the memory, also the information on the starting and stopping date of the event, respectively “Time1” and “Time2” for **Reg**-type recordings, while date and time are indicated for **Istant** instant sampling.

The following operations are possible only on the screen in Fig. 95:

1. Use the up and down arrow keys to highlight (blue background) one of the recordings on the screen. Press the **F1** key (or the **INFO** item on the display). The instrument shows the screen containing the main information regarding the recording performed as described in chapter 5.5.1.
2. Press the **F3** key (or the **CANC.ULT** item on the display) to delete the **last saved recording**. The instrument shows the message “Delete last recording?”. Confirm the operation with “Ok” or “Cancel” to go back to the screen.
3. Press the **F4** key (or the **CANC.TOT** item on the display) to delete **all recordings in the memory**. The instrument shows the message “Delete all recordings?”. Confirm the operation with “Ok” or “Cancel” to go back to the previous screen.

5.5.1. Recording analysis (Reg type)

This page shows the analyses which can be performed on the saved data (Reg type).

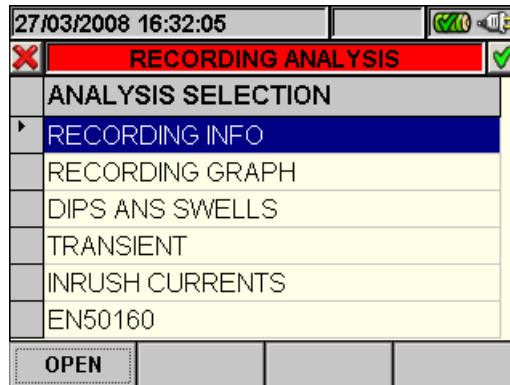



Fig. 96: Recording analysis (Reg-type data)

1. Use the up and down arrow keys to highlight on blue background one of the analyses on the screen. Press the **F1** or **ENTER** key (or the **OPEN** item or the smart icon  on the display) to confirm the type of analysis to be performed.
2. Press the **ESC** key (or the smart icon ) to exit the function and go back to the “Saved data” page (Fig. 95).

5.5.1.1. Recording information

This page contains general information about the recording (Reg) file previously selected in the Saved Data Management MENU.

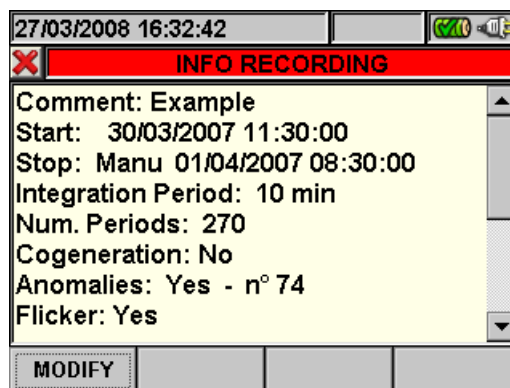



Fig. 97: Recording info

1. In these conditions, the **F1** key (or the **MODIFY** key on the display) is active and it is possible to modify and save the comment line by using the virtual keyboard (see § 5.4.2.1).
2. Press the **ESC** key (or the smart icon ) to exit the function and go back to the “Recording analysis” page (Fig. 96).

5.5.1.2. Recording graph

By selecting the recording graph option, the following page is accessed, which enables the user to display the recording trend (ONLY ONE parameter at a time).

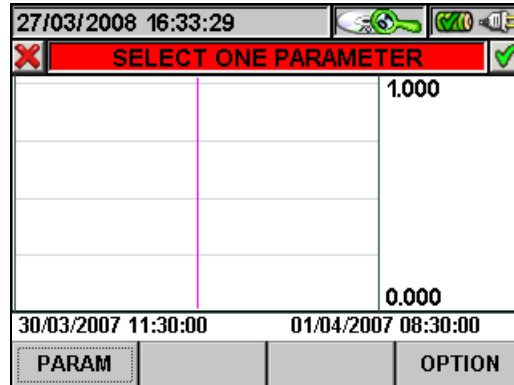

Fig. 98: Selecting a parameter

1. Press the **F1** key (or the **PARAM** item on the display) to access the page containing the recorded quantities available for the analysis (Fig. 99).

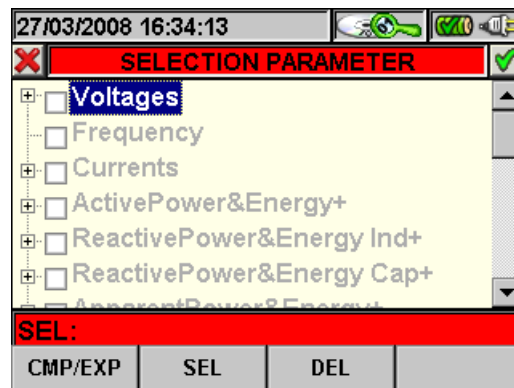

Fig. 99: Parameter selection

The following keys are active on this page:

- The up and down arrow keys move the cursor along the quantity tree
- The **F1** key (or the **CMP/EXP** item on the display) compresses and expands the tree of the quantity highlighted by the cursor
- The **F2** key (or the **SEL** item on the display) selects or deselects the parameter highlighted by the cursor
- The **ENTER** key (or the smart icon on the display) confirms the selection previously made and displays the graph of the selected parameter (Fig. 100)
- The **CANC** key deselects the parameter previously selected, independently from the position of the cursor
- The **ESC** key (or smart icon) to exit the function and go back to the “Selecting a parameter” page (Fig. 98).

This page shows the graph, the cursor position (cursor T) and the maximum, minimum and average RMS values of the parameter selected by the cursor.

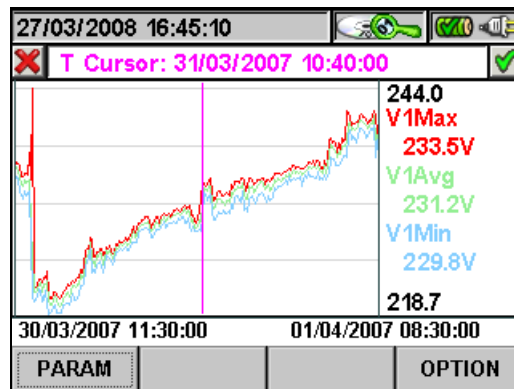



Fig. 100: Recording graph

The following keys are active on this page:

- **F1** key (or **PARAM** item on the display) to access the page of the selectable parameters (Fig. 99)
 - **F4** key (or **OPTIONS** item on the display) to access the page for the activation of the “Advanced graph” (Fig. 101)
 - The **ESC** key (or smart icon ) to exit the function and go back to the “Recording analysis” page (Fig. 96).
2. Press the **F4** key (or the **OPTIONS** item on the display) to access the page for the activation of the Advanced graph (Fig. 101).

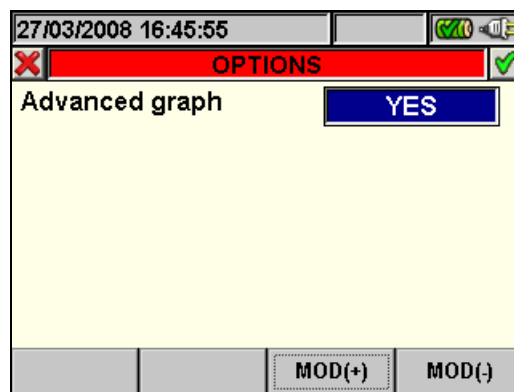



Fig. 101: Options (Advanced graph)

The following keys are active on this page:

- The **F3** and **F4** keys (or the **MOD(+)** and **MOD(-)** items on the display) enable the user to choose **YES** or **NO** for the advanced graph.
- The **ENTER** key (or the smart icon ) confirms the selection previously made.
- The **ESC** key (or smart icon ) to exit the function and go back to the “Selecting a parameter” page (Fig. 98).

Example of advanced graph.

Let us take a recording of 2000 pixels into consideration. The PQA has a display with a useful resolution of about 200 pixels; therefore, it is not able to distinctly display all the pixels in our recording. How does it operate then? The first pixel in the graphs of the curves “Max value”, “Average value” and “Min value” will be the analysis of the 10 first corresponding pixels of the recording, i.e.:

- For the Max value graph, the highest value of the 10 recorded values for the corresponding channel will be displayed.
- For the Min value graph, the lowest value of the 10 recorded values for the corresponding channel will be displayed.
- For the Average value graph, the first value of the 10 recorded values for the corresponding channel will be displayed.

Similarly, the second pixel will be the analysis of the following 10 pixels, and so on until the whole graph is generated.

3. Press the **ESC** key (or the smart icon ) to exit the function and go back to the “Selecting a parameter” page (Fig. 98).

5.5.1.3. Dips ans swells

This page shows a table containing all voltage anomalies occurred during recording.

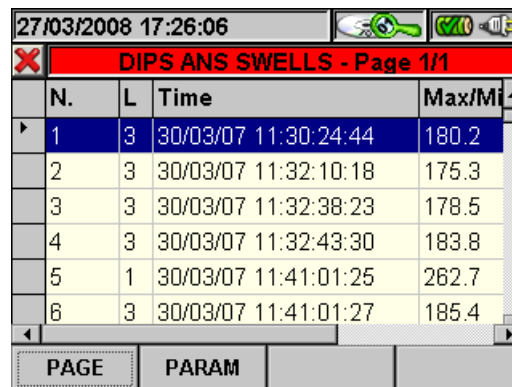

N.	L	Time	Max/Min
1	3	30/03/07 11:30:24:44	180.2
2	3	30/03/07 11:32:10:18	175.3
3	3	30/03/07 11:32:38:23	178.5
4	3	30/03/07 11:32:43:30	183.8
5	1	30/03/07 11:41:01:25	262.7
6	3	30/03/07 11:41:01:27	185.4

Fig. 102: Dips ans swells

Column description:

- N.:** Progressive number of the anomaly.
- L.:** Phase in which the anomaly occurred.
- Date/Time:** Date/time at which the anomaly occurred.
- Max/Min:** Maximum/minimum value of the anomaly.
- Duration:** Duration of the anomaly.
- Type:** Type of anomaly (voltage reduction or overvoltage).

The following keys are active on this page:

- The up and down arrow keys move the cursor along the voltage anomalies.
- The up and down arrow keys move the column display to the right or to the left.
- The **F1** key (or the **PAG** item on the display) advances to the following page of voltage anomalies (to be selected with the **F3** or **F4** key or through the items **MOD (+)** or **MOD (-)** on the display).
- The **F2** key (or the **PARAM** item on the display) accesses the page showing the settings for voltage anomalies (Fig. 103).
- The **ESC** key (or smart icon ) to exit the function and go back to the “Recording analysis” page (Fig. 96).

This page shows the parameters set before recording voltage anomalies:

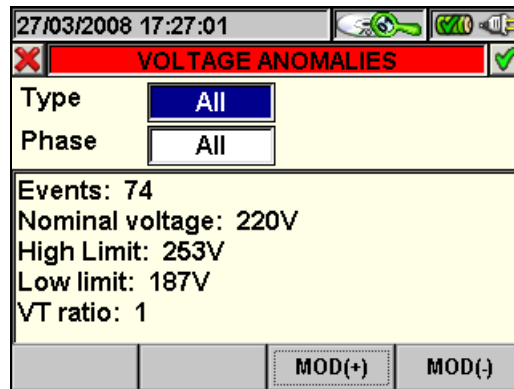

Fig. 103: Voltage Anomalies

The following non-modifiable parameters are indicated (as they have been set upon starting the recording).

Nominal Voltage: Nominal voltage.



High Voltage: Limit high voltage.

Low Voltage: Limit low voltage.

TV: Transformation ratio of the voltage transformers.

This page also shows the total number of voltage anomalies occurred (**Number of Anomalies**).

The following keys are active on this page:

- The up and down arrow keys move the cursor alternatively on **Type** or **Phase**.
- The **F3** and **F4** keys (or the **MOD(+)** and **MOD(-)** items on the display) enable the user to filter the anomalies to be selected. It is possible to select **All**, **Up**, **Down**, **Int** (if the cursor highlights **Type**) and **All**, **Phase1**, **Phase2**, **Phase3** (if the cursor highlights **Phase**).
- The **ENTER** key (or the smart icon ) confirms the selection previously made and displays the table of voltage anomalies.
- The **ESC** key (or the smart icon ) to exit the functions and go back to the “Anomalies” page (Fig. 102).

5.5.1.4. Fast transient

This page shows a table reporting all transients, i.e. all those phenomena which are associated to phase voltage, characterized by:

- Fast variations of the voltage waveform slope.
- Exceeding of a limit threshold defined by the user before recording.

N.	L	Time	Peak+
1	1	30/03/07 11:43:00:62	485.3
2	1	30/03/07 11:43:00:74	501.9
3	1	30/03/07 11:43:00:86	505.2
4	1	30/03/07 11:43:01:10	41.6
5	3	30/03/07 11:43:01:76	0.0
6	3	30/03/07 11:43:01:76	40.9

Fig. 104: Fast transients

Column description:

- N.:** Progressive number of the transient.
- L.:** Phase in which the transient occurred.
- Date/Time:** Date/time at which the anomaly occurred.
- Peak+:** Max. positive value reached by the transient during the observation interval.
- Peak-:** Min. negative value reached by the transient during the observation interval.
- Delta+:** Max. relative positive range reached by the transient during the observation interval.
- Delta-:** Min. relative negative range reached by the transient during the observation interval.
- Type:** Type of transient (Up/Down).
- F/S:** Transient speed (Fast if $dV/dt > 100V/5\mu s$, Slow if $dV/dt > 100V/78\mu s$).

The following keys are active on this page:

- The up and down arrow keys move the cursor along the transients.
- The up and down arrow keys move the column display to the right or to the left.
- The **F1** key (or the **PAG** item on the display) advances to the following page of transients (to be selected with the **F3** or **F4** key or through the items **MOD (+)** or **MOD (-)** on the display).
- The **F2** key (or the **PARAM** item on the display) accesses the page showing the settings for transients (Fig. 105).
- The ESC (or the smart icon ) to exit the function and go back to the “Recording analysis” page (Fig. 96).

This page shows the parameters set before recording voltage transients:

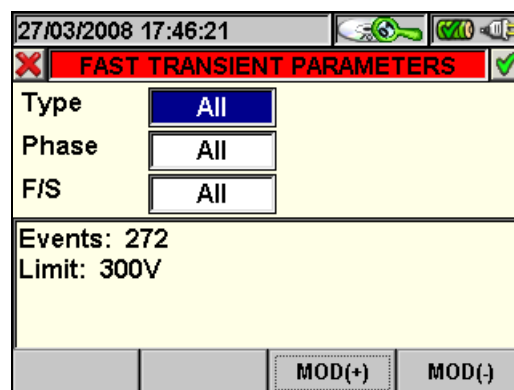



Fig. 105: Fast transients parameters

The following values are indicated:

Limit: set voltage threshold.

This page also shows the total number of transients occurred (**Events**).

The following keys are active on this page:

- The up and down arrow keys move the cursor alternatively on **Type**, **Phase** or **F/S**.
- The **F3** and **F4** keys (or the **MOD(+)** and **MOD(-)** items on the display) enable the user to filter the transients to be selected. It is possible to select **All**, **Up**, **Down** (if the cursor highlights **Type**); **All**, **Phase1**, **Phase2**, **Phase3**, **Neutral** (if the cursor highlights **Phase**); **All**, **Fast**, **Slow** (if the cursor highlights **F/S**).
- The **ENTER** key (or the smart icon ) confirms the selection previously made and displays the table of voltage transients.
- The **ESC** key (or the smart icon ) to exit the functions and go back to the “Fast transients” page (Fig. 104).

5.5.1.5. Inrush currents

This page shows a table containing all inrush currents occurred during recording.

N.	L	Time	Max[A]
1	1	30/03/07 11:41:00:34	20.7
2	2	30/03/07 11:41:00:34	21.0
3	3	30/03/07 11:41:00:34	20.7
4	1	30/03/07 11:42:00:80	22.3
5	2	30/03/07 11:42:00:80	22.8
6	3	30/03/07 11:42:00:80	22.6

Fig. 106: Inrush currents

Column description:

- N.:** Progressive number of the inrush current.
- L.:** Phase in which the inrush current occurred.
- Date/Time:** Date/time at which the inrush current occurred.
- Max[A]:** Maximum value reached by the inrush current.

The following keys are active on this page:

- The up and down arrow keys move the cursor along the inrush currents.
- The up and down arrow keys move the column display to the right or to the left.
- The **F1** key (or the **PAG** item on the display) advances to the following page of inrush currents (to be selected with the **F3** or **F4** key or through the items **MOD (+)** or **MOD (-)** on the display).
- The **F2** key (or the **PARAM** item on the display) accesses the page showing the settings for inrush currents (Fig. 107).
- The **F3** key (or the **GRAPH** item on the display) accesses the page showing the graph for the inrush current selected (Fig. 108).
- The **ESC** key (or the smart icon ) to exit the function and go back to the “Recording analysis” page (Fig. 96).

This page shows the parameters set before recording inrush currents:

INRUSH PARAMETER	
Phase	All
Events:	12
Type:	fix
Limit:	15A
Length:	4sec
<input style="border: 1px dashed gray;" type="button" value="MOD(+)"/> <input type="button" value="MOD(-)"/>	

Fig. 107: Inrush current parameters

The following data are indicated:

- Type:** Type of measurement set:
- Fix:** The instrument has detected and saved an event when the current's RMS value, calculated in each half-period, exceeded the value of the threshold defined by the user.
 - Var:** The instrument has detected and saved an event each time the current's RMS value, calculated in each half-period, exceeded the previous RMS value (i.e. the RMS value calculated in the previous half-period) by a quantity equal to the threshold defined by the user.
- Limit:** Set current threshold.
- Duration:** Set observation interval.

This page also shows the total number of inrush currents occurred (**Number of Inrush Currents**).

The following keys are active on this page:

- The **F3** and **F4** keys (or the **MOD(+)** and **MOD(-)** items on the display) enable the user to filter the inrush currents to be selected. It is possible to select **All**, **Phase1**, **Phase2**, **Phase3**, **Neutral**.
- The **ENTER** key (or the smart icon on the display) confirms the selection previously made and displays the table of inrush currents.
- The **ESC** key (or the smart icon) to exit the function and go back to the “Inrush currents” page (Fig. 106).

This page shows the graph, the cursor position, the maximum/minimum current and voltage values, the current and voltage value relative to the cursor position of the selected inrush current.

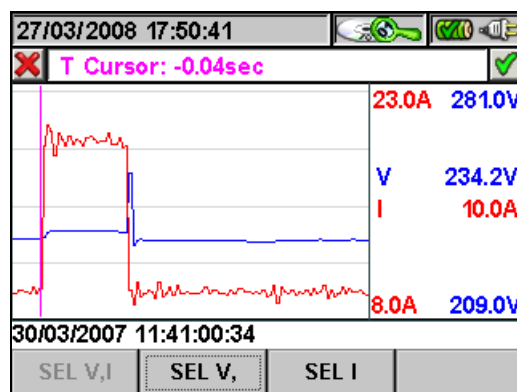

Fig. 108: Inrush current graph

The following keys are active on this page:

- The **F1** key (or the **SEL V,I** item on the display) shows the voltage and current graph.
- The **F2** key (or the **SEL V** item on the display) shows the voltage graph.
- The **F3** key (or the **SEL I** item on the display) shows the current graph.
- The right and left arrow keys move the cursor to the right or to the left along the graph.
- The **ESC** key (or the smart icon) to exit the function and go back to the “Inrush currents” page (Fig. 106).

5.5.1.6. EN50160

This page shows a table containing all values according to standard CEI EN50160.

Param.	OK	p%@Lim	Min	Max
Hz 95%	OK	100.00	49.90	50.10
Hz 100%	OK	100.00	49.90	50.10
V1 95%	OK	100.00	219.80	240.80
V2 95%	OK	100.00	199.90	221.80
V3 95%	NO	82.96	173.20	204.80
V1 100%	OK	100.00	219.80	240.80

Fig. 109: EN50160 analysis result

Column description:

- Param:** The percentages of the values are indicated, which must be within the limits set in **Limits**. Example: **Hz 100%** means that the 100% of the frequency values recorded must be within a range of **1%, -1%** of the frequency nominal value.
- OK:** **YES** indicates that the analysis is successful, **NO** indicates that the analysis is not successful.
- p%@Lim:** Percentage of the measured values which is within the set limits.
- Min:** Minimum measured value.
- Max:** Maximum measured value.
- Limits:** Set reference limits.

The following keys are active on this page:

- The up and down arrow keys move the cursor along the different quantities.
- The up and down arrow keys move the column display to the right or to the left.
- The **F1** key (or the **PARAM** item on the display) accesses the page showing the settings (Fig. 110).
- The **F2** key (or the **GRAPH** item on the display) accesses the page showing the histogram for the quantities in the table (Fig. 111).
- The **ESC** key (or the smart icon on the display) to exit the function and go back to the "Recording analysis" page (Fig. 96).

This page contains the global result of the EN50160 analysis, the connection condition of the system and the parameters set before recording.

27/03/2008 17:52:17		EN50160 OUTCOME: NO	
Interconnected System		NO	
Events: 74			
Nominal voltage: 220V			
High Limit: 253V			
Low limit: 187V			
Frequency: 50Hz			
		MOD(+)	MOD(-)



Fig. 110: Parameters set for EN50160 analysis

The following data are indicated:

Nominal Voltage: Set nominal voltage.
High Voltage: Limit high voltage.
Low Voltage: Limit low voltage.
Frequency: System frequency.

This page also shows the total number of voltage anomalies occurred (**Number of Anomalies**).

The following keys are active on this page:

- The **F3** and **F4** keys (or the **MOD(+)** and **MOD(-)** items on the display) enable the user to choose **YES** or **NO** for the interconnected system.
- The **ENTER** key (or the smart icon  on the display) confirms the selection previously made and displays the table of the values according to standard CEI EN 50160.
- The **ESC** key (or the smart icon  on the display) to exit the function and go back to the “EN50160 analysis result” page (Fig. 109).

This page shows:

- The global result of the analysis, in red if **Non-Ok** and in green if **Ok**.
- The quantity histogram. The green bar indicates that the parameter complies with standard EN50160, while the red bar indicates that the parameter does not comply with the standard.

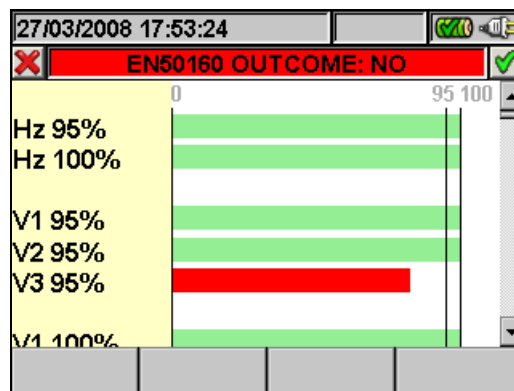



Fig. 111: EN50160 analysis histogram

The following keys are active on this page:

- The up and down arrow keys move the vertical bar up or down, thus enabling the user to display the EN50160 analysis quantity histogram.
- The **ESC** key (or the smart icon  on the display) to exit the function and go back to the “EN50160 analysis result” page (Fig. 109).

5.5.1.7. Analysis of consumed energy

This page shows the Energy and Peak power values consumed while recording

07/05/2015 11:26:11			
X TOT. ENERGY CONSUMPTION - Pag 7/9			
Eact	=	583 Wh	
Ppeak	=	21.80 kW	
Date Ppeak	:	07/05/15 11:24:20	
Start rec.	:	07/05/15 11:22:00	
Stop rec.	:	07/05/15 11:25:35	
Rec. Time	:	00d 00h 03m	
Int. Per.	:	1 min	Rec. : 10
PAGE	SCOPE	HARM	VECTORS

Fig. 112: Screen of total consumed energy

Description of the displayed values:

- Eact:** Total active power consumed while Recording.
- Ppeak:** Max. active power peak (measured on 16 periods of mains frequency) consumed while recording
- Date Ppeak:** Date and time in which the power peak occurred
- Start rec.:** Starting date of the recording
- Stop rec.:** Stopping date of the recording
- Rec. Time** Recording time expressed in days (d), hours (h) and minutes (m)
- Int. Per:** Set integration period value

CAUTION



The Total Consumed Energy page is shown only if general parameter Total "Active Power & Energy" has been recorded (see § 5.4.6.1).

5.5.1.8. Analysis of produced energy

This page shows the Energy and Peak power values produced while recording

07/05/2015 11:26:17			
TOT. ENERGY PRODUCTION - Pag 9/9			
Eact	=	15 Wh	
Ppeak	=	1.31 kW	
Date Ppeak	:	07/05/15 11:24:20	
Start rec.	:	07/05/15 11:22:00	
Stop rec.	:	07/05/15 11:25:35	
Rec. Time	:	00d 00h 03m	
Int. Per.	:	1 min	Rec. : 10
PAGE	SCOPE	HARM	VECTORS

Fig. 113: Screen of total produced energy

Description of the displayed values:

- Eact:** Total active power produced while Recording.
- Ppeak:** Max. active power peak (measured on 16 periods of mains frequency) produced while recording
- Date Ppeak:** Date and time in which the power peak occurred
- Start rec.:** Starting date of the recording
- Stop rec.:** Stopping date of the recording
- Rec. Time** Recording time expressed in days (d), hours (h) and minutes (m)
- Int. Per.:** Set integration period value

CAUTION



The Total Produced Energy page is shown only if general parameter Total "Active Power & Energy" has been recorded (see § 5.4.6.1) and if the recording parameter "Co-generation" has been enabled (see §).

5.5.2. Recording analysis (Istant type)

This page shows the analyses which can be performed on the saved data (Istant type).

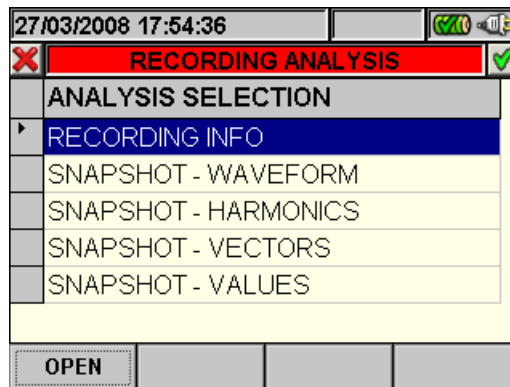



Fig. 114: Recording analysis (Istant-type data)

1. Use the up and down arrow keys to highlight on blue background one of the analyses on the screen. Press the **F1** or **ENTER** key (or the **OPEN** item or the smart icon  on the display) to confirm the type of analysis to be performed.
2. Press the **ESC** key (or the smart icon  on the display) to exit the function and go back to the "Saved data" page (Fig. 95).

5.5.2.1. Recording information

This page contains general information about the saved (Istant) file previously selected in the Saved Data Management MENU.

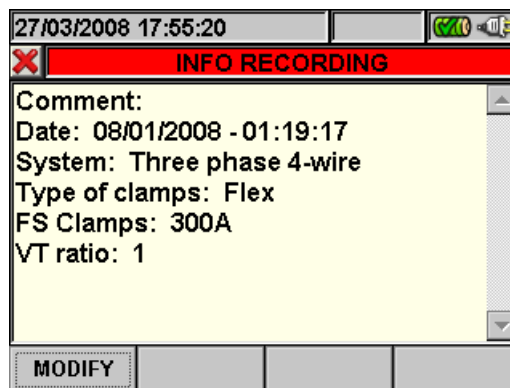



Fig. 115: Recording info

1. In these conditions, the **F1** key (or the **MODIFY** key on the display) is active and it is possible to modify and save the comment line by using the virtual keyboard (see § 5.4.2.1).
2. Press the **ESC** key (or the smart icon  on the display) to exit the function and go back to the "Recording analysis" page (Fig. 114).

5.5.2.2. Graph

This screen (Fig. 116) contemporarily shows the saved instant values of the waveforms of voltages V1, V2, V3, Vn scaled according to the Full scale (Fs) and the relevant RMS values; these values have been saved by the instrument upon pressing the **SAVE** key. As an example, below are shown the screens relative to a **three phase 4-wire system**. Similar consideration can be applied to any other selected system

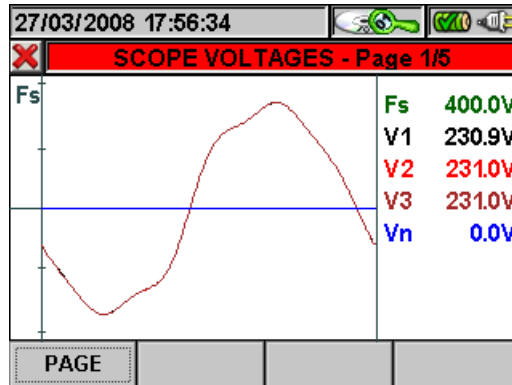

Fig. 116: Voltage scope in three-phase 4-wire system

The following keys are active on this page:

- The up (**ZOOM+**) or down (**ZOOM-**) arrow keys zoom in or out the displayed waveforms.
- The **F1** key (or the **PAG** item on the display) advances to the following page of saved current values.
- The **ESC** key (or the smart icon on the display) to exit the function and go back to the "Recording analysis" page (Fig. 114).

5.5.2.3. Harmonics analysis

This screen (Fig. 117) displays the harmonic values and the THD% value of voltages V1, V2, V3, Vn and of currents I1, I2, I3 and of Neutral current In in a graph (scaled according to the Full scale Fs) or in a table. The values displayed are percentage values of the fundamental or absolute values according to the configuration set in the **ANALYZER CONFIGURATION MENU -> ADVANCED**. As an example, below are shown the screens relative to a **three phase 4-wire system**. Similar consideration can be applied to any other selected system

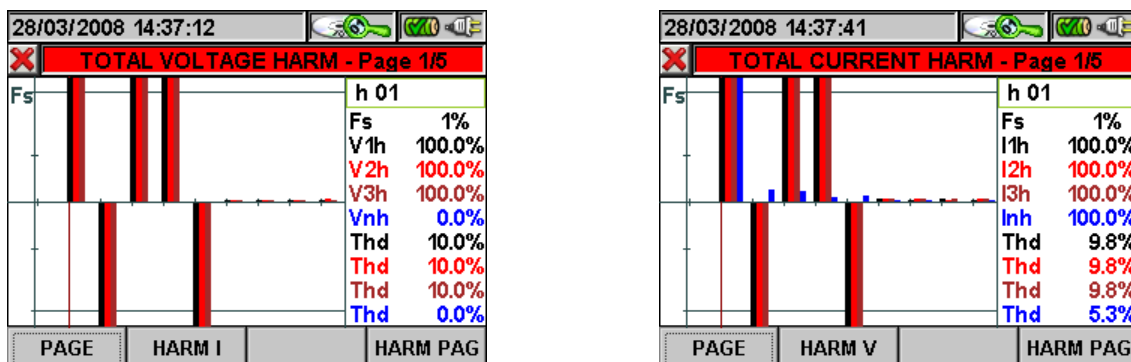



Fig. 117: Total harmonics in three-phase 4-wire system

Should only the voltage signals or only the current signals be connected to the instrument's inputs, all displayed harmonics will be shown in the upper half plane of the graph. If both voltage and current signals are connected to the instrument's inputs, the histogram bars representing the harmonics will be shown respectively:

- In the upper half plane of the graph if the harmonics are introduced into the relevant electrical system from the mains.
- In the lower half plane of the graph if the harmonics are injected into the relevant electrical system from the mains.

The following keys are active on this page:

- The up (**ZOOM+**) or down (**ZOOM-**) arrow keys zoom in or out the histogram.
- The right and left arrow keys move the cursor to the right or to the left along the harmonics.
- The **F1** key (or the **PAG** item on the display) advances to the following page of saved values, relative to phase 1 harmonics.
- The **F2** key (or the **ARM V** or **ARM I** item on the display) switches between total voltage and current harmonics.
- The **F4** key (or the **ARM PAG** item on the display) displays the following harmonics group. 0..9, 10..19, 20..29, 30..39, 40..49.
- The **ESC** key (or the smart icon  on the display) to exit the function and go back to the "Recording analysis" page (Fig. 114)

5.5.2.4. Vectors

As an example, below are shown the screens relative to a **three phase 4-wire system**. Similar consideration can be applied to any other selected system. This screen (Fig. 118) displays, with graphic and numeric indications, the phase delays expressed in degrees [°] between:

- Voltage V1 and V2, V2 and V3, V3 and V1.
- Voltage V1 and current I1
- Voltage V2 and current I2
- Voltage V3 and current I3

The latter allow finding out the inductive or capacitive nature of the electrical installation. In detail:

- Positive angle: Inductive load.
- Negative angle: Capacitive load.

The N-PE voltage and Neutral current vectors are also represented.

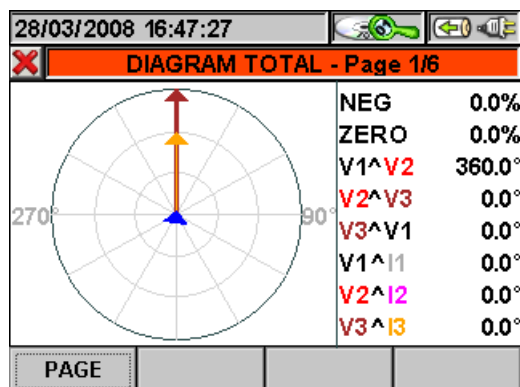



Fig. 118: Total vector diagram in three-phase 4-wire system

The following keys are active on this page:

- The **F1** key (or the **PAG** item on the display) advances to the following page of saved values relative to the voltage vector diagram.
- The **ESC** key (or the smart icon  on the display) to exit the function and go back to the "Recording analysis" page (Fig. 114).

5.5.2.5. Measures

As an example, below are shown the screens relative to a **three phase 4-wire system**. Similar consideration can be applied to any other selected system. In measure mode, the instrument displays the saved values in TRMS as shown in the following figures:

28/03/2008 16:58:26				
TOTAL RMS VALUES - Page 1/5				
V1N	V2N	V3N	VNPE	V
230.9	231.0	231.0	0.0	V
V12	V23	V31		V
0.2	0.1	0.2		V
NEG%	ZERO%	SEQ	Hz	
50.8	100.0	132	50.0	
I1	I2	I3	IN	A
100.5	101.4	100.9	0.0	A
PAGE				

In this page, the following symbols are used:

V1N → Neutral - Phase L1 Voltage

V2N → Neutral - Phase L2 Voltage

V3N → Neutral - Phase L3 Voltage

VNPE → Neutral - Ground Voltage

V12 → Phase L1 - Phase L2 Voltage

V23 → Phase L2 - Phase L3 Voltage

V31 → Phase L3 - Phase L1 Voltage

Inv% → % value of the Negative sequence unbalance

Omo% → % value of the Zero sequence unbalance

SEQ → Phase sequence:

"123" => Correct

"132" => Not correct

"023" => No Voltage on B1

"103" => No Voltage on B2

"120" => No Voltage on B3

"100" => No Voltage on B2 and B3

"020" => No Voltage on B1 and B3

"003" => No Voltage on B1 and B2

Hz → Frequency

I1 → Current on Phase L1

I2 → Current on Phase L2

I3 → Current on Phase L3

IN → Neutral Current

Fig. 119: Page 1/5 of numeric values for three-phase 4-wire system

The following keys are active on this page:

- The **F1** key (or the **PAG** item on the display) advances to the following page of saved values.
- The **ESC** key (or the smart icon on the display) to exit the function and go back to the "Recording analysis" page (Fig. 114).

5.5.3. Transfer recordings to a external Pen Driver USB

The meter permits to transfer of one or more saved recordings which are shown in Fig. 95 to a external Pen Driver USB directly connected to it (see Fig. 3). The below picture is shown by meter:

N.	Type	Time 1	Time 2
1	Rec	22/12/2014	22/12/2014
2	Rec	07/01/2015	07/01/2015
3	Rec	07/01/2015	07/01/2015
4	Snapshot	29/04/2015	15:40:00
5	Snapshot	29/04/2015	15:40:00
6	Snapshot	29/04/2015	15:41:00

Fig. 120: Recording results screen with Pen Driver USB connected

Press **F2** key (or the **COPY** now active at display). The below virtual keyboard screen, where the user can define the file name to save inside Pen Driver USB, is shown by meter:

Fig. 121: Definition of file name which is saved on Pen Driver USB



Press **SAVE** or **ENTER** keys (or the smart icon ) to confirm the file name or press **ESC** key (or the smart icon ) to exit without saving. In case of file just exist inside Pen Driver USB, the below warning message is shown by meter:

Fig. 122: Confirm to overwrite file

Press “Ok” to overwrite the file name or “Cancel” to exit without modify. Press **ESC** key (or the smart icon ) to back to GENERAL MENU screen.

5.5.4. Saving recordings to external Compact Flash (only PQA82x)

The PQA82x meter permits to save the recordings also on external standard compact flash which are fitted on suitable input (see Fig. 3) after activating “EXTERNAL” option on **Memory type** (see § 5.1.7). The following is shown by meter:

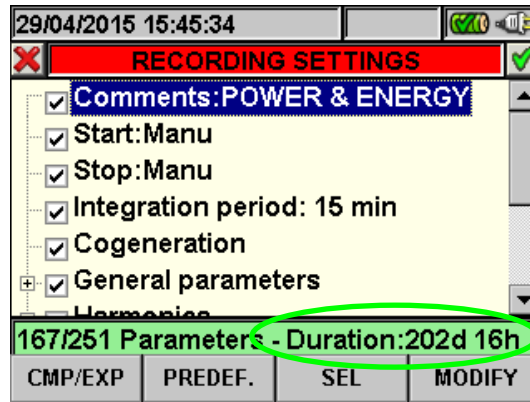



Fig. 123: Example of use of external memory - compact flash not fitted

In the example of Fig. 123 a “POWER & ENERGY predefined configuration with an autonomy of 202d 16h in condition of compact flash not fitted was been considered. Insert compact flash on meter, exit from the above screen by pressing **ESC** key (or the smart icon ) and open again the same screen, the below screen is shown by meter:

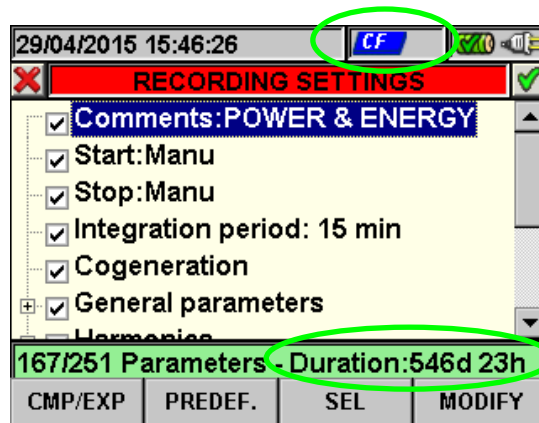

Fig. 124: Example of use of external memory - compact flash fitted

The correspondent icon is shown by meter in the top of display after fitted the Compact Flash on meter and the value of autonomy is automatically updated at display (546d 23h in the example of Fig. 124).

CAUTION



The passage from internal memory (about 15Mbytes) to external memory with compact flash option permits to save a recording with size up to **32Mbytes** independently on dimension in Mbytes size of compact flash.

5.6. METER INFORMATION

Inside this section the general internal parameters of meter are available as information from the user for example during any contact with Service people of HT ITALIA.

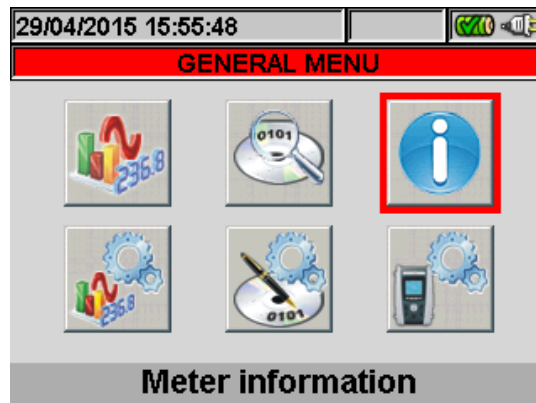

Fig. 125: Menu General screen – Meter information section

Press **ENTER** key or touch the correspondent icon at display. The below screen is shown by meter:

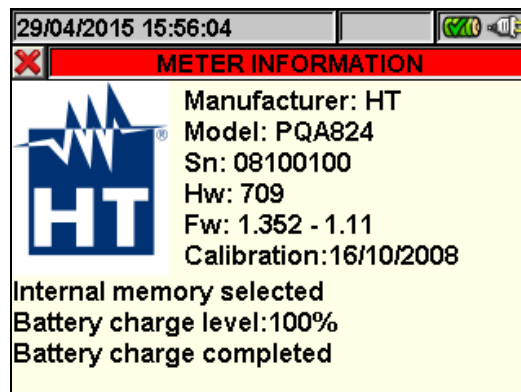



Fig. 126: Meter information screen

The following meaning of the items inside the above screen:

Item	Description
Manufacturer	Name of manufacturer
Model	Name of model
Sn	Serial number of meter
Hw	Internal Hardware version of meter
Fw	Internal Firmware version of meter
Calibration	Date of last calibration performed
Selection of type of memory	Internal or external memory
Battery charge level	Percentage of charge level of battery

Press **ESC** key (or smart icon ) to back to GENERAL MENU screen.

6. CONNECTION OF METER TO PC (WITH WIN XP)

1. Install the **TopView** standard software on your PC.
2. Verify the presence of ActiveSync icon with **grey** background (not active) on the right bottom part of PC screen as shown in below picture:



Fig. 127: ActiveSync icon not active

3. Connect the meter to PC using the standard C2007 cable (USB "A" → USB "B") as shown in below screen:

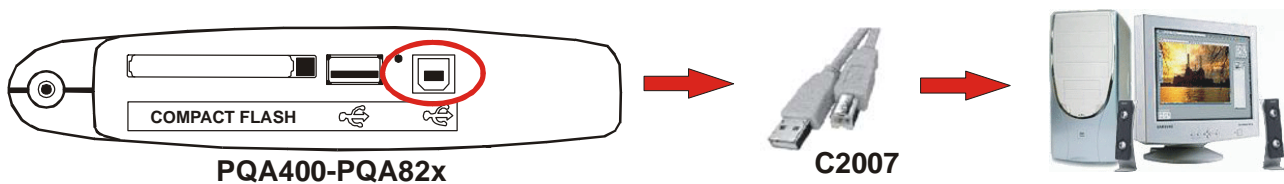

Fig. 128: Connection of meter to PC

4. Verify the presence of ActiveSync icon with **green** background (active) on the right bottom part of PC screen as shown in below picture. Only in this order the connection of meter to PC is correct



Fig. 129: ActiveSync icon active

5. Run **TopView** software and click on "**Instrument <-> PC connection**" key. Press the "Select new instrument" key in software screen in order to acknowledge the name of connected meter, which is shown in the bottom status bar. Select "PQA823", "PQA824" or "PQA400" model from the available list of meters only for the first connection.
6. Select the "Download data" command and pressing "Next" key in order to open the "**Download**" windows on software which the all saved data by meter are shown. Select one or more desired recordings and click on "Download" key.
7. Downloading procedure is start and the total recording analysis window is shown by software at the and of this operation.

For any detail about use please refer to TopView HELP ON LINE feature.

CAUTION



- During a recording running is not possible to perform the download of data to PC. Press **GO/STOP** key on meter to stop recording before download operation.
- Let the meter always in GENERAL MENU screen to perform the dual communication between meter and PC.

7. MEASURING PROCEDURES

7.1. USING OF METER IN A SINGLE PHASE SYSTEM – ENG TYPE



CAUTION

The maximum voltage among B1, B2, B3, B4 and BE inputs is 1000V / CAT IV 600V to ground. Do not measure voltages exceeding the limits prescribed by this manual. Should you exceed the voltage limits you could damage the instrument and/or its components or endanger your safety.

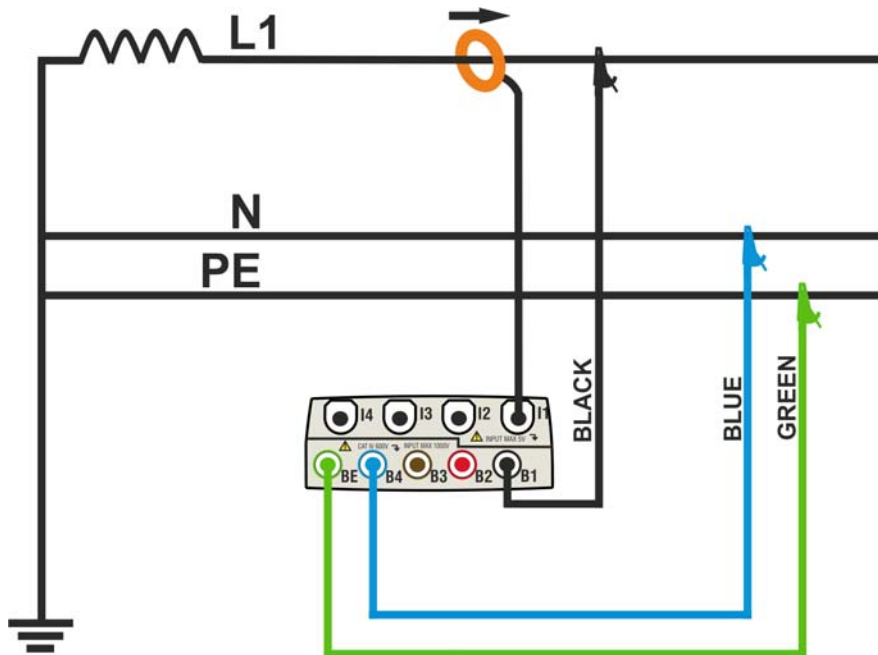

Fig. 130: Meter connection in a SINGLE phase system

CAUTION



If possible, before connecting the meter to the electrical equipment to be tested turn the power supply off.

1. Check and modify the basic settings of meter if necessary (see § 5.3.1). Set **SINGLE** system option.
2. Connect voltage test leads on Phase, Neutral and Ground cables considering the colours as shown in Fig. 130).
3. Connect the transducer current clamp on L1 Phase cable as shown in Fig. 130) respecting the clamp's arrow direction indicating the current standard sequence from generator to load. **On Real Time Values' section screens always verify the positive value of Active Power and the power factor relative to load which should be normally inductive** before starting a recording. Reverse the clamp by 180 degrees on cables in case of negative readings.
4. Supply the electrical installation under test in case this was temporarily put out of service for meter connection. The values of parameters are shown by meter at display in Real Time Values section (see § 5.2).
5. Press **SAVE** key if an instantaneous sample of display values (Instant) should be saved (see § 5.5). Use **HOLD** function to stop the values at display if necessary.
6. Check all settings before start a recording (see § 5.4). Press **GO/STOP** key to enable and disable a recording on meter (see § 5.4.13)

7.2. USING OF METER IN A SINGLE PHASE SYSTEM – ENG_UK TYPE

CAUTION



The maximum voltage among B1, B2, B3, B4 and BE inputs is 1000V / CAT IV 600V to ground. Do not measure voltages exceeding the limits prescribed by this manual. Should you exceed the voltage limits you could damage the instrument and/or its components or endanger your safety.

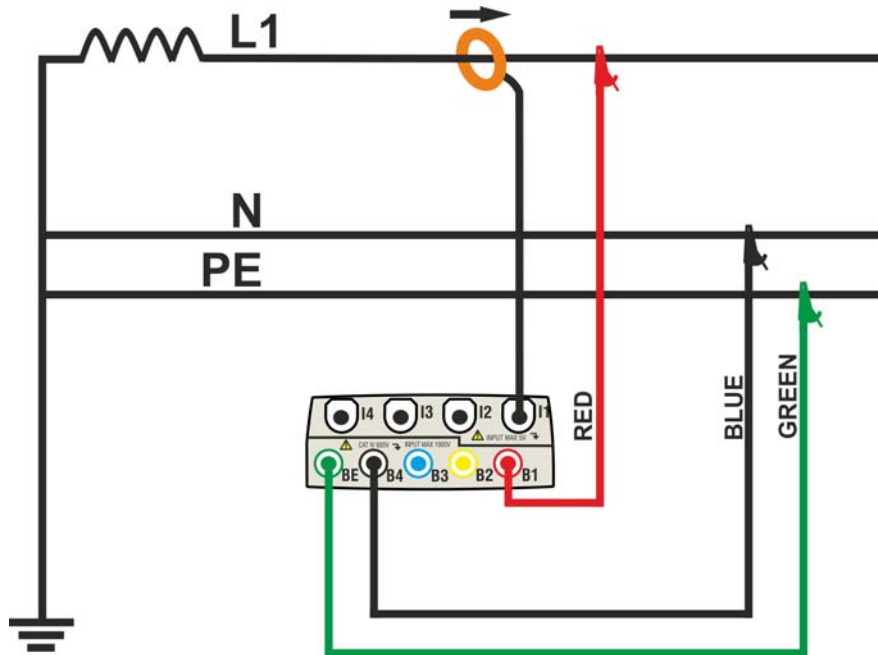

Fig. 131: Meter connection in a Single phase system – ENG_UK type

CAUTION



If possible, before connecting the meter to the electrical equipment to be tested turn the power supply off.

1. Check and modify the basic settings of meter if necessary (see § 5.3.1). Set **SINGLE** system option.
2. Connect voltage test leads on Phase, Neutral and Ground cables considering the colours as shown in Fig. 131).
3. Connect the transducer current clamp on L1 Phase cable as shown in Fig. 131) respecting the clamp's arrow direction indicating the current standard sequence from generator to load. **On Real Time Values' section screens always verify the positive value of Active Power and the power factor relative to load which should be normally inductive** before starting a recording. Reverse the clamp by 180 degrees on cables in case of negative readings.
4. Supply the electrical installation under test in case this was temporarily put out of service for meter connection. The values of parameters are shown by meter at display in Real Time Values section (see § 5.2).
5. Press **SAVE** key if an instantaneous sample of display values (Instant) should be saved (see § 5.5). Use **HOLD** function to stop the values at display if necessary.
6. Check all settings before start a recording (see § 5.4). Press **GO/STOP** key to enable and disable a recording on meter (see § 5.4.13)

7.3. USING OF METER IN A 3-PHASE 4 WIRE SYSTEM – ENG TYPE

CAUTION



The maximum voltage among B1, B2, B3, B4 and BE inputs is 1000V / CAT IV 600V to ground. Do not measure voltages exceeding the limits prescribed by this manual. Should you exceed the voltage limits you could damage the instrument and/or its components or endanger your safety.

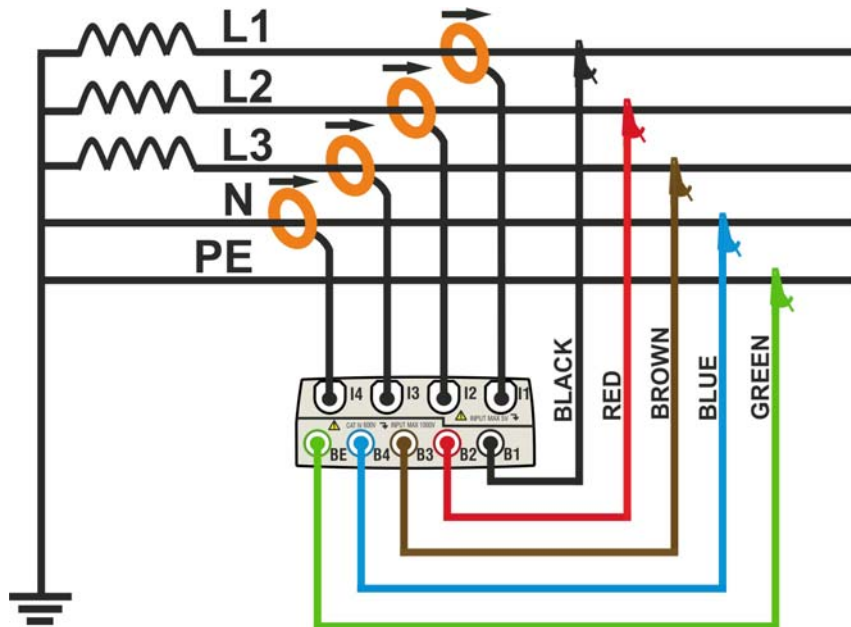

Fig. 132: Meter connection in a three phase 4WIRE system – ENG type

CAUTION



If possible, before connecting the meter to the electrical equipment under test turn the power supply off.

1. Check and modify the basic settings of meter if necessary (see § 5.3.1). Set **4WIRE** system option.
2. Connect voltage test leads on Phases L1, L2, L3, Neutral and Ground cables considering the colours as shown in Fig. 132. **Verify the result “123” at display relative to a correct phase sequence indication** (see § 5.2.1) and perform the corrections if necessary.
3. Connect the transducer current clamps on Phase L1, L2, L3 and Neutral N cables as shown in Fig. 132 respecting the clamp’s arrow direction indicating the current standard sequence from generator to load. **On Real Time Values’ section screens always verify the positive value of Active Power and the power factor relative to each load which should be normally inductive** before starting a recording. Reverse the clamp by 180 degrees on cables in case of negative readings.
4. Supply the electrical installation under test in case it was temporarily put out of service for meter connection. The values of parameters are shown by meter at display in Real Time Values’ section (see § 5.2).
5. Press **SAVE** key if a instantaneous sample of display values (Instant) should be saved (see § 5.5). Use **HOLD** function to stop the values at display if necessary.
6. Check all settings before start a recording (see § 5.4). Press **GO/STOP** key to enable and disable a recording on meter (see § 5.4.13).

7.4. USING OF METER IN A 3-PHASE 4 WIRE SYSTEM – ENG_UK TYPE

CAUTION



The maximum voltage among B1, B2, B3, B4 and BE inputs is 1000V / CAT IV 600V to ground. Do not measure voltages exceeding the limits prescribed by this manual. Should you exceed the voltage limits you could damage the instrument and/or its components or endanger your safety.

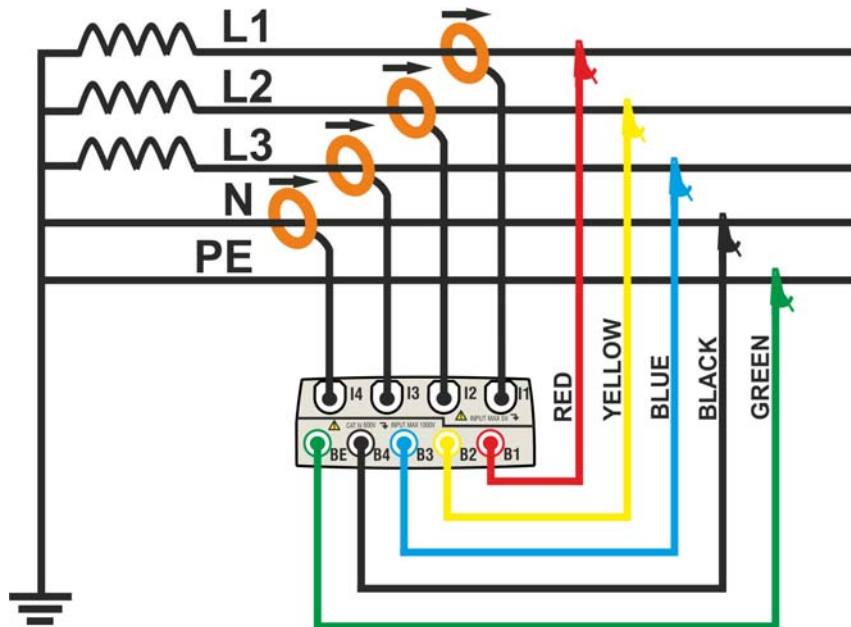

Fig. 133: Meter connection in a three phase 4WIRE system – ENG_UK type

CAUTION



If possible, before connecting the meter to the electrical equipment under test turn the power supply off.

1. Check and modify the basic settings of meter if necessary (see § 5.3.1). Set **4WIRE** system option.
2. Connect voltage test leads on Phases L1, L2, L3, Neutral and Ground cables considering the colours as shown in Fig. 133. **Verify the result “123” at display relative to a correct phase sequence indication** (see § 5.2.1) and perform the corrections if necessary.
3. Connect the transducer current clamps on Phase L1, L2, L3 and Neutral N cables as shown in respecting the clamp’s arrow direction indicating the current standard sequence from generator to load. **On Real Time Values’ section screens always verify the positive value of Active Power and the power factor relative to each load which should be normally inductive** before starting a recording. Reverse the clamp by 180 degrees on cables in case of negative readings.
4. Supply the electrical installation under test in case it was temporarily put out of service for meter connection. The values of parameters are shown by meter at display in Real Time Values’ section (see § 5.2).
5. Press **SAVE** key if a instantaneous sample of display values (Instant) should be saved (see § 5.5). Use **HOLD** function to stop the values at display if necessary.
6. Check all settings before start a recording (see § 5.4). Press **GO/STOP** key to enable and disable a recording on meter (see § 5.4.13)

7.5. USING OF METER IN A THREE PHASE 3 WIRE SYSTEM – ENG TYPE

CAUTION



The maximum voltage among B1, B2, B3, B4 and BE inputs is 1000V / CAT IV 600V to ground. Do not measure voltages exceeding the limits prescribed by this manual. Should you exceed the voltage limits you could damage the instrument and/or its components or endanger your safety.

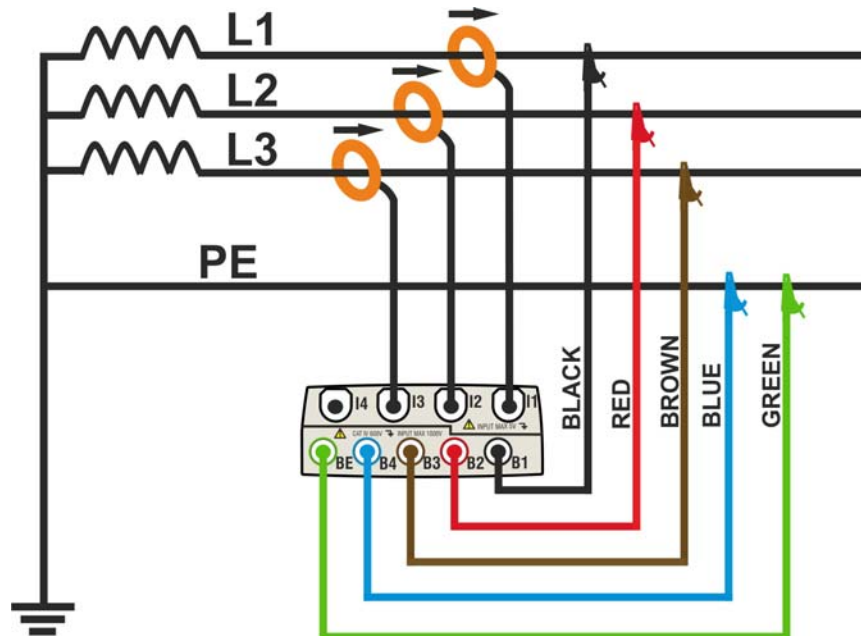

Fig. 134: Meter connection in a three phase 3WIRE system

CAUTION



If possible, before connecting the meter to the electrical equipment under test turn the power supply off.

1. Check and modify the basic settings of meter if necessary (see § 5.3.1). Set **3WIRE** system option.
2. Connect voltage test leads on Phases L1, L2, L3, and Ground cables respecting the colours as shown in Fig. 134. **Verify the result “123” at display relative to a correct phase sequence indication** (see § 5.2.1) and perform the corrections if necessary.
3. Connect the transducer current clamps on Phase L1, L2, L3 cables as shown in Fig. 134 respecting the clamp's arrow direction indicating the current standard sequence from generator to load. **On Real Time Values' section screens always verify the positive value of Active Power and the power factor relative to load which should be normally inductive** before starting a recording. Reverse the clamp by 180 degrees on cables in case of negative readings.
4. Supply the electrical installation under test in case it was temporarily put out of service for meter connection. The values of parameters are shown by meter at display in Real Time Values' section (see § 5.2).
5. Press **SAVE** key if a instantaneous sample of display values (Instant) should be saved (see § 5.5). Use **HOLD** function to stopping the values at display if necessary.
6. Check all settings before start a recording (see § 5.4). Press **GO/STOP** key to enable and disable a recording on meter (see § 5.4.13).

7.6. USING OF METER IN A THREE PHASE 3 WIRE SYSTEM – ENG_UK TYPE

CAUTION



The maximum voltage among B1, B2, B3, B4 and BE inputs is 1000V / CAT IV 600V to ground. Do not measure voltages exceeding the limits prescribed by this manual. Should you exceed the voltage limits you could damage the instrument and/or its components or endanger your safety.

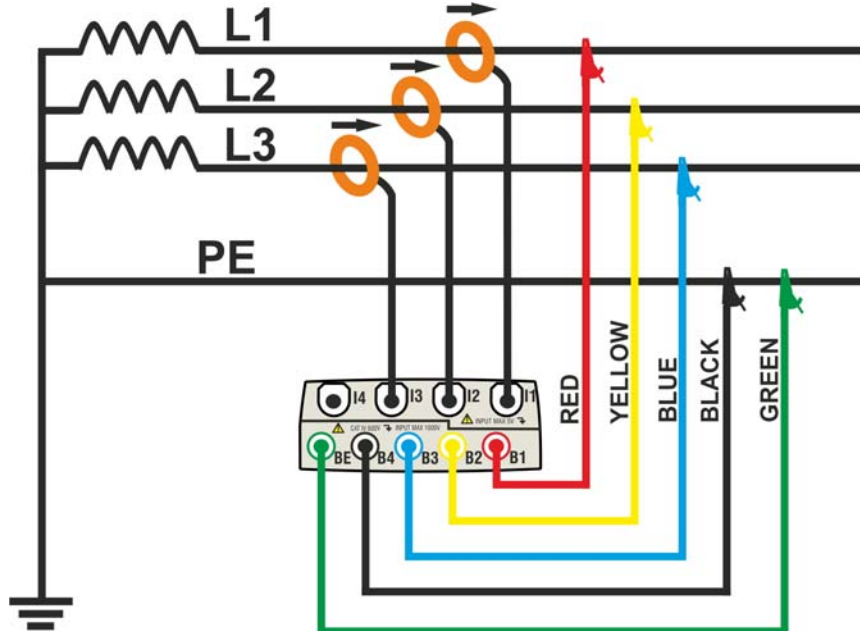

Fig. 135: Meter connection in a three phase 3WIRE system – ENG_UK type

CAUTION



If possible, before connecting the meter to the electrical equipment under test turn the power supply off.

1. Check and modify the basic settings of meter if necessary (see § 5.3.1). Set **3WIRE** system option.
2. Connect voltage test leads on Phases L1, L2, L3, and Ground cables respecting the colours as shown in Fig. 135. **Verify the result “123” at display relative to a correct phase sequence indication** (see § 5.2.1) and perform the corrections if necessary.
3. Connect the transducer current clamps on Phase L1, L2, L3 cables as shown in Fig. 135 respecting the clamp's arrow direction indicating the current standard sequence from generator to load. **On Real Time Values' section screens always verify the positive value of Active Power and the power factor relative to load which should be normally inductive** before starting a recording. Reverse the clamp by 180 degrees on cables in case of negative readings.
4. Supply the electrical installation under test in case it was temporarily put out of service for meter connection. The values of parameters are shown by meter at display in Real Time Values' section (see § 5.2).
5. Press **SAVE** key if a instantaneous sample of display values (Instant) should be saved (see § 5.5). Use **HOLD** function to stopping the values at display if necessary.
6. Check all settings before start a recording (see § 5.4). Press **GO/STOP** key to enable and disable a recording on meter (see § 5.4.13)

7.7. USING OF METER IN A THREE PHASE 3 WIRE ARON SYSTEM – ENG TYPE

CAUTION



The maximum voltage among B1, B2, B3, B4 and BE inputs is 1000V / CAT IV 600V to ground. Do not measure voltages exceeding the limits prescribed by this manual. Should you exceed the voltage limits you could damage the instrument and/or its components or endanger your safety.

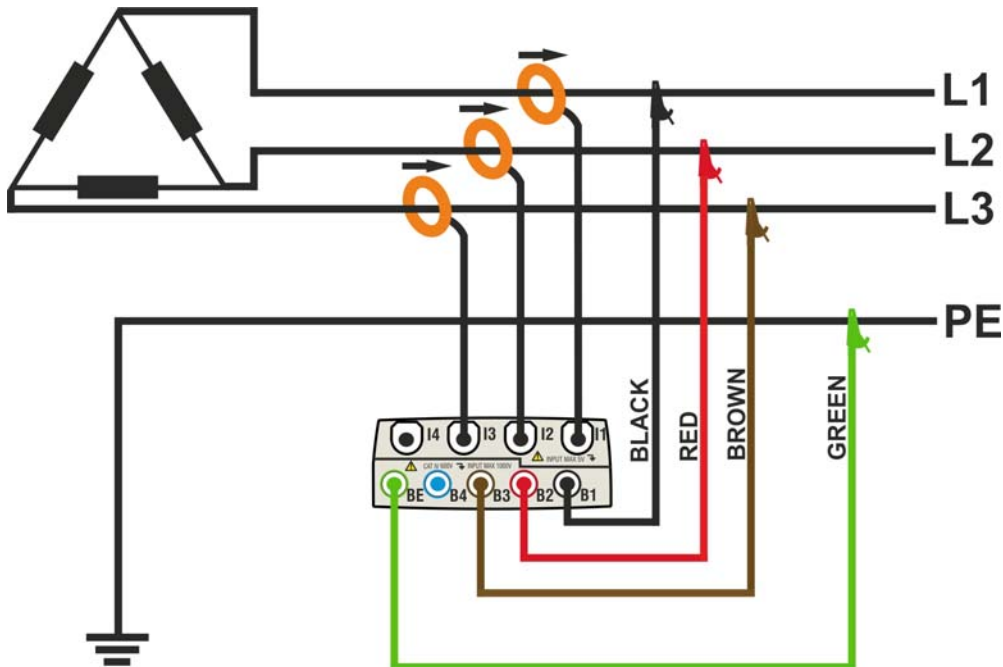

Fig. 136: Meter connection in a three phase ARON system – ENG type

CAUTION



If possible, before connecting the meter to the electrical equipment under test turn the power supply off.

1. Check and modify the basic settings of meter if necessary (see § 5.3.1). Set **ARON** system option.
2. Connect voltage test leads on Phases L1, L2, L3, and Ground cables considering the colours as shown in Fig. 136. **Verify the result “123” at display relative to a correct phase sequence indication** (see § 5.2.1) and perform the corrections if necessary.
3. Connect the transducer current clamps on Phase L1, L2, L3 cables as shown in Fig. 136 respecting the clamp's arrow direction indicating the current standard sequence from generator to load. **On Real Time Values' section screens (selecting a 3 wire system preliminarily) always verify the positive value of Active Power and the power factor relative to load which should be normally inductive** before starting a recording. Reverse the clamp by 180 degrees on cables in case of negative readings.
4. Supply the electrical installation under test in case it was temporarily put out of service for meter connection. The values of parameters are shown by meter at display in Real Time Values' section (see § 5.2).
5. Press **SAVE** key if a instantaneous sample of display values (Instant) should be saved (see § 5.5). Use **HOLD** function to stopping the values at display if necessary
6. Check all settings before start a recording (see § 5.4). Press **GO/STOP** key to enable and disable a recording on meter (see § 5.4.13)

7.8. USING OF METER IN A 3-PHASE 3 WIRE ARON SYSTEM – ENG_UK TYPE

CAUTION



The maximum voltage among B1, B2, B3, B4 and BE inputs is 1000V / CAT IV 600V to ground. Do not measure voltages exceeding the limits prescribed by this manual. Should you exceed the voltage limits you could damage the instrument and/or its components or endanger your safety.

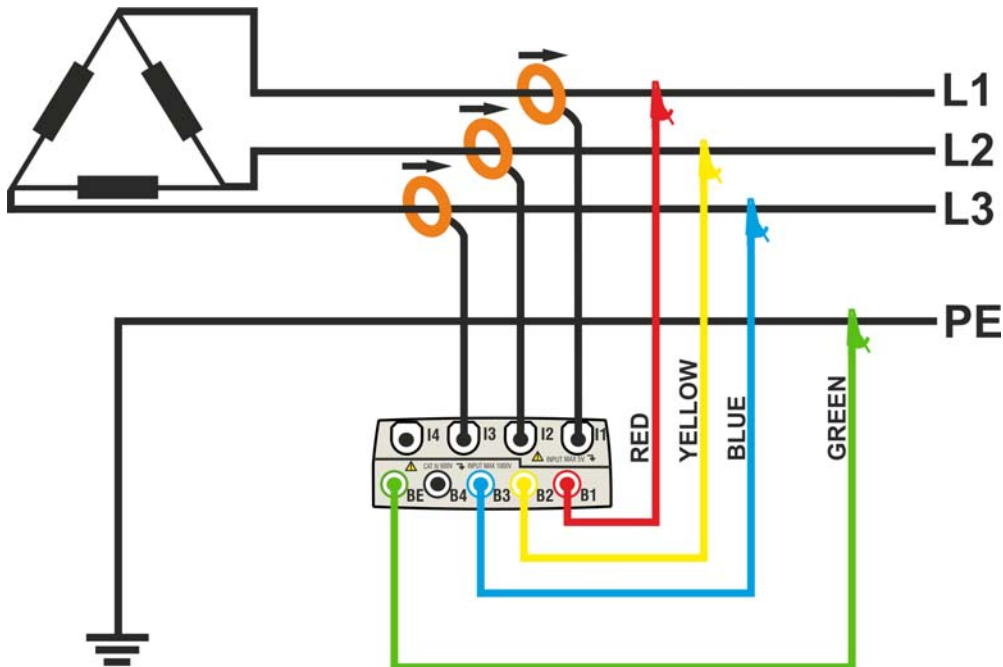

Fig. 137: Meter connection in a 3-phase ARON system – ENG_UK type

CAUTION



If possible, before connecting the meter to the electrical equipment under test turn the power supply off.

1. Check and modify the basic settings of meter if necessary (see § 5.3.1). Set **ARON** system option.
2. Connect voltage test leads on Phases L1, L2, L3, and Ground cables considering the colours as shown in Fig. 137. **Verify the result “123” at display relative to a correct phase sequence indication** (see § 5.2.1) and perform the corrections if necessary.
3. Connect the transducer current clamps on Phase L1, L2, L3 cables as shown in Fig. 137 respecting the clamp's arrow direction indicating the current standard sequence from generator to load. **On Real Time Values' section screens (selecting a 3 wire system preliminarily) always verify the positive value of Active Power and the power factor relative to load which should be normally inductive** before starting a recording. Reverse the clamp by 180 degrees on cables in case of negative readings.
4. Supply the electrical installation under test in case it was temporarily put out of service for meter connection. The values of parameters are shown by meter at display in Real Time Values' section (see § 5.2).
5. Press **SAVE** key if a instantaneous sample of display values (Instant) should be saved (see § 5.5). Use **HOLD** function to stopping the values at display if necessary
6. Check all settings before start a recording (see § 5.4). Press **GO/STOP** key to enable and disable a recording on meter (see § 5.4.13)

7.9. USING OF METER IN A 3-PHASE 4-WIRE 3PHL (USA SYSTEM) – ENG TYPE

CAUTION



The maximum voltage among B1, B2, B3, B4 and BE inputs is 1000V / CAT IV 600V to ground. Do not measure voltages exceeding the limits prescribed by this manual. Should you exceed the voltage limits you could damage the instrument and/or its components or endanger your safety.

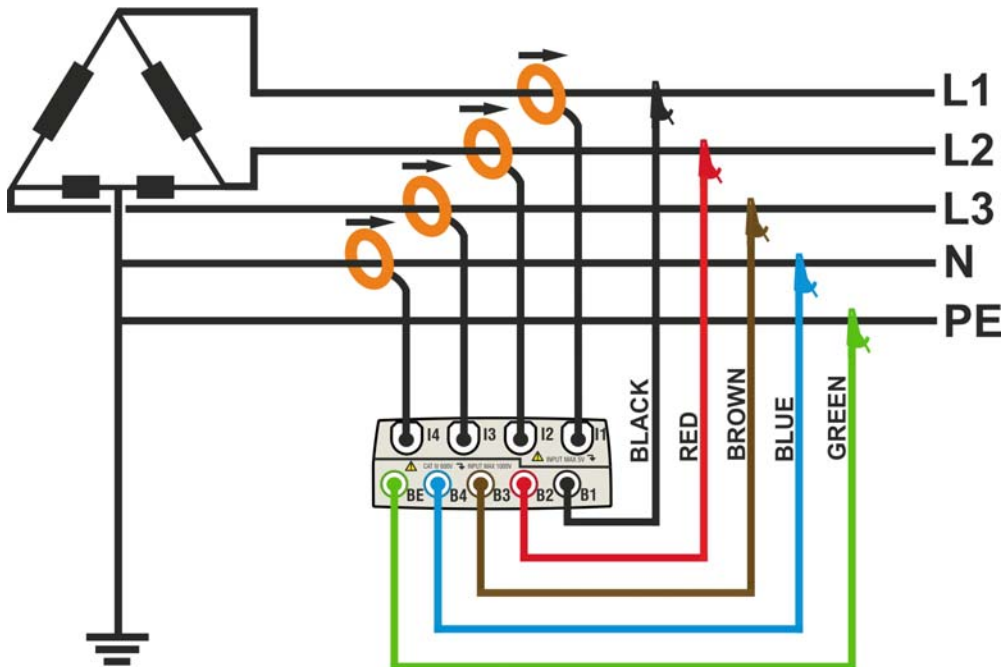

Fig. 138: Meter connection in a three phase 3PHL system – ENG type

CAUTION



If possible, before connecting the meter to the electrical equipment under test turn the power supply off.

1. Check and modify the basic settings of meter if necessary (see § 5.3.1). Set **3PHL** system option.
2. Connect voltage test leads on Phases L1, L2, L3, N and PE cables considering the colours as shown in Fig. 138. **Verify the result “123” at display relative to a correct phase sequence indication** (see § 5.2.1) and perform the corrections if necessary.
3. Connect the transducer current clamps on Phase L1, L2, L3 and N cables as shown in Fig. 138 respecting the clamp's arrow direction indicating the current standard sequence from generator to load. **On Real Time Values' section screens (selecting a 3 wire system preliminarily) always verify the positive value of Active Power and the power factor relative to load which should be normally inductive** before starting a recording. Reverse the clamp by 180 degrees on cables in case of negative readings.
4. Supply the electrical installation under test in case it was temporarily put out of service for meter connection. The values of parameters are shown by meter at display in Real Time Values' section (see § 5.2).
5. Press **SAVE** key if a instantaneous sample of display values (Instant) should be saved (see § 5.5). Use **HOLD** function to stopping the values at display if necessary
6. Check all settings before start a recording (see § 5.4). Press **GO/STOP** key to enable and disable a recording on meter (see § 5.4.13)

7.10. USING IN A 3-PHASE 4-WIRE 3PHL (USA SYSTEM) – ENG_UK TYPE
CAUTION

The maximum voltage among B1, B2, B3, B4 and BE inputs is 1000V / CAT IV 600V to ground. Do not measure voltages exceeding the limits prescribed by this manual. Should you exceed the voltage limits you could damage the instrument and/or its components or endanger your safety.

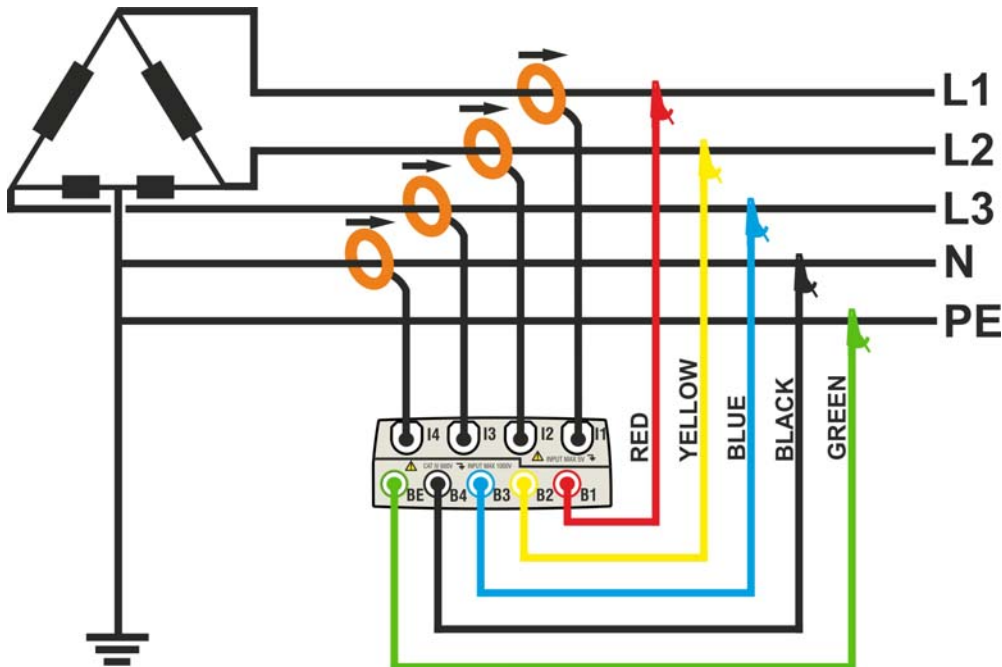

Fig. 139: Meter connection in a three phase 3PHL system – ENG_UK type

CAUTION

If possible, before connecting the meter to the electrical equipment under test turn the power supply off.

1. Check and modify the basic settings of meter if necessary (see § 5.3.1). Set **3PHL** system option.
2. Connect voltage test leads on Phases L1, L2, L3, N and PE cables considering the colours as shown in Fig. 139. **Verify the result “123” at display relative to a correct phase sequence indication** (see § 5.2.1) and perform the corrections if necessary.
3. Connect the transducer current clamps on Phase L1, L2, L3 and N cables as shown in Fig. 139 respecting the clamp's arrow direction indicating the current standard sequence from generator to load. **On Real Time Values' section screens (selecting a 3 wire system preliminarily) always verify the positive value of Active Power and the power factor relative to load which should be normally inductive** before starting a recording. Reverse the clamp by 180 degrees on cables in case of negative readings.
4. Supply the electrical installation under test in case it was temporarily put out of service for meter connection. The values of parameters are shown by meter at display in Real Time Values' section (see § 5.2).
5. Press **SAVE** key if a instantaneous sample of display values (Instant) should be saved (see § 5.5). Use **HOLD** function to stopping the values at display if necessary
6. Check all settings before start a recording (see § 5.4). Press **GO/STOP** key to enable and disable a recording on meter (see § 5.4.13)

7.11. USING OF METER IN A 3-PHASE 3-WIRE 3POD (USA SYSTEM) – ENG TYPE
CAUTION

The maximum voltage among B1, B2, B3, B4 and BE inputs is 1000V / CAT IV 600V to ground. Do not measure voltages exceeding the limits prescribed by this manual. Should you exceed the voltage limits you could damage the instrument and/or its components or endanger your safety.

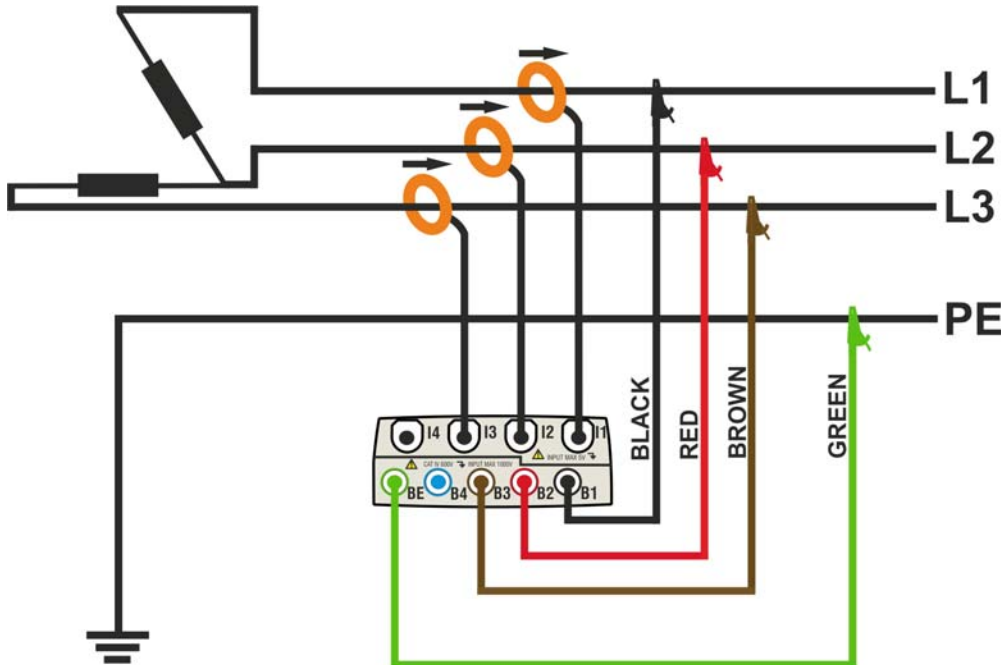

Fig. 140: Meter connection in a three phase 3POD system

CAUTION

If possible, before connecting the meter to the electrical equipment under test turn the power supply off.

1. Check and modify the basic settings of meter if necessary (see § 5.3.1). Set **3P OD** system option.
2. Connect voltage test leads on Phases L1, L2, L3 and PE cables considering the colours as shown in Fig. 140. **Verify the result “123” at display relative to a correct phase sequence indication** (see § 5.2.1) and perform the corrections if necessary.
3. Connect the transducer current clamps on Phase L1, L2, L3 cables as shown in Fig. 140 respecting the clamp’s arrow direction indicating the current standard sequence from generator to load. **On Real Time Values’ section screens (selecting a 3 wire system preliminarily) always verify the positive value of Active Power and the power factor relative to load which should be normally inductive** before starting a recording. Reverse the clamp by 180 degrees on cables in case of negative readings.
4. Supply the electrical installation under test in case it was temporarily put out of service for meter connection. The values of parameters are shown by meter at display in Real Time Values’ section (see § 5.2).
5. Press **SAVE** key if a instantaneous sample of display values (Instant) should be saved (see § 5.5). Use **HOLD** function to stopping the values at display if necessary
6. Check all settings before start a recording (see § 5.4). Press **GO/STOP** key to enable and disable a recording on meter (see § 5.4.13)

7.12. USING OF METER IN 3-PHASE 3-WIRE 3POD (USA SYSTEM) – ENG_UK TYPE
CAUTION

The maximum voltage among B1, B2, B3, B4 and BE inputs is 1000V / CAT IV 600V to ground. Do not measure voltages exceeding the limits prescribed by this manual. Should you exceed the voltage limits you could damage the instrument and/or its components or endanger your safety.

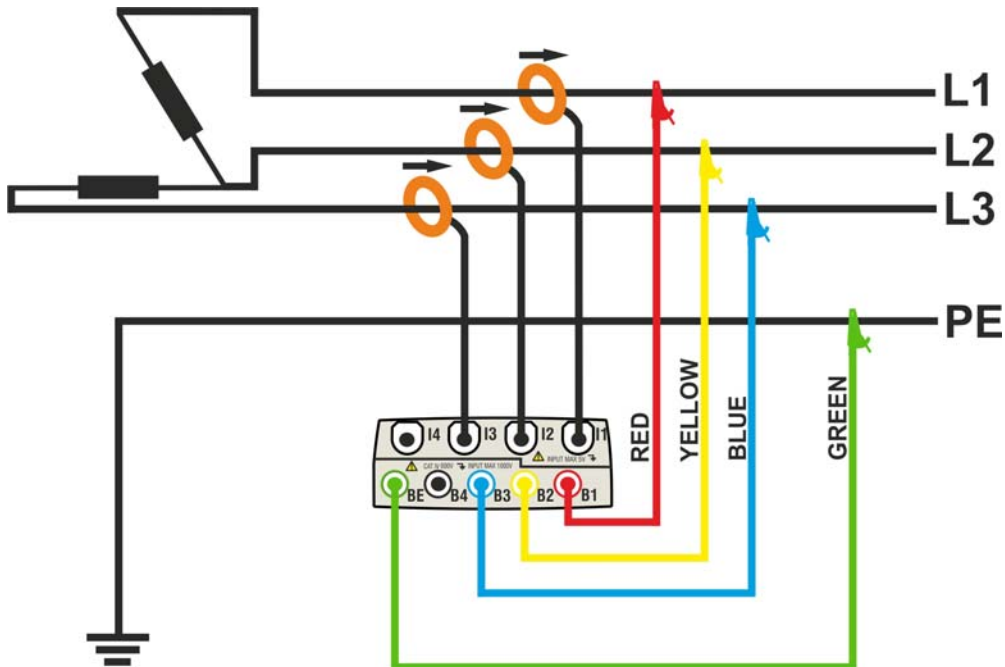

Fig. 141: Meter connection in a three phase 3-wire 3POD system – ENG_UK type

CAUTION

If possible, before connecting the meter to the electrical equipment under test turn the power supply off.

1. Check and modify the basic settings of meter if necessary (see § 5.3.1). Set **3P OD** system option.
2. Connect voltage test leads on Phases L1, L2, L3 and PE cables considering the colours as shown in Fig. 141. **Verify the result “123” at display relative to a correct phase sequence indication** (see § 5.2.1) and perform the corrections if necessary.
3. Connect the transducer current clamps on Phase L1, L2, L3 cables as shown in Fig. 141 respecting the clamp’s arrow direction indicating the current standard sequence from generator to load. **On Real Time Values’ section screens (selecting a 3 wire system preliminarily) always verify the positive value of Active Power and the power factor relative to load which should be normally inductive** before starting a recording. Reverse the clamp by 180 degrees on cables in case of negative readings.
4. Supply the electrical installation under test in case it was temporarily put out of service for meter connection. The values of parameters are shown by meter at display in Real Time Values’ section (see § 5.2).
5. Press **SAVE** key if a instantaneous sample of display values (Instant) should be saved (see § 5.5). Use **HOLD** function to stopping the values at display if necessary
6. Check all settings before start a recording (see § 5.4). Press **GO/STOP** key to enable and disable a recording on meter (see § 5.4.13)

7.13. USING OF METER IN A 3 WIRE 3P2E (USA SYSTEM) – ENG TYPE

CAUTION



The maximum voltage among B1, B2, B3, B4 and BE inputs is 1000V / CAT IV 600V to ground. Do not measure voltages exceeding the limits prescribed by this manual. Should you exceed the voltage limits you could damage the instrument and/or its components or endanger your safety.

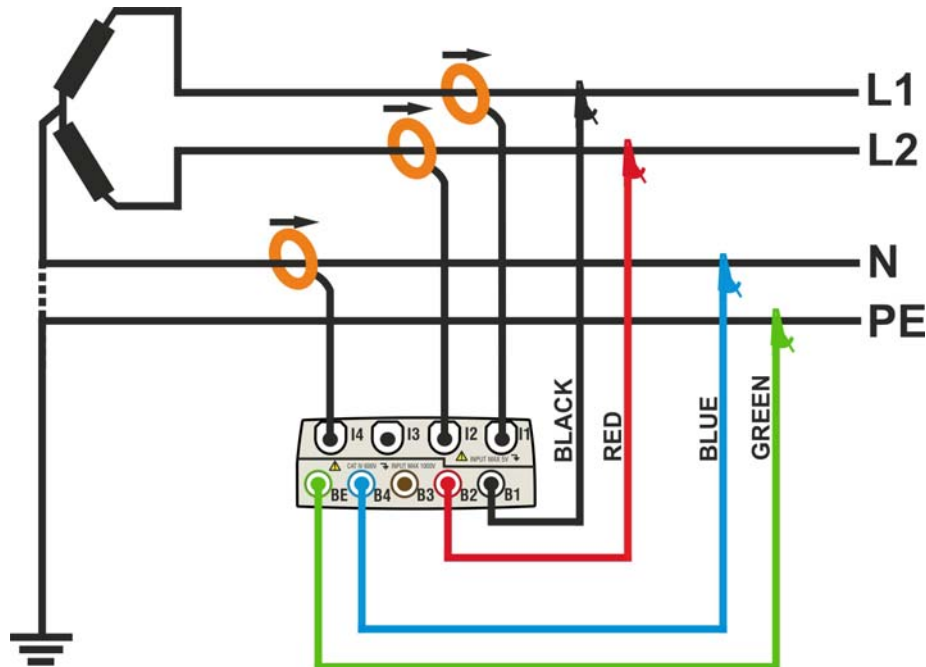

Fig. 142: Meter connection in a two phase 3-wire 3P2E system – ENG type

CAUTION



If possible, before connecting the meter to the electrical equipment under test turn the power supply off.

1. Check and modify the basic settings of meter if necessary (see § 5.3.1). Set **3P 2E** system option.
2. Connect voltage test leads on Phases L1, L2, N and PE cables considering the colours as shown in Fig. 142
3. Connect the transducer current clamps on Phase L1, L2, N cables as shown in Fig. 142 respecting the clamp's arrow direction indicating the current standard sequence from generator to load. **On Real Time Values' section screens (selecting a 3 wire system preliminarily) always verify the positive value of Active Power and the power factor relative to load which should be normally inductive before starting a recording.** Reverse the clamp by 180 degrees on cables in case of negative readings.
4. Supply the electrical installation under test in case it was temporarily put out of service for meter connection. The values of parameters are shown by meter at display in Real Time Values' section (see § 5.2).
5. Press **SAVE** key if a instantaneous sample of display values (Instant) should be saved (see § 5.5). Use **HOLD** function to stopping the values at display if necessary
6. Check all settings before start a recording (see § 5.4). Press **GO/STOP** key to enable and disable a recording on meter (see § 5.4.13)

7.14. USING OF METER IN A 3 WIRE 3P2E (USA SYSTEM) – ENG_UK TYPE

CAUTION



The maximum voltage among B1, B2, B3, B4 and BE inputs is 1000V / CAT IV 600V to ground. Do not measure voltages exceeding the limits prescribed by this manual. Should you exceed the voltage limits you could damage the instrument and/or its components or endanger your safety.

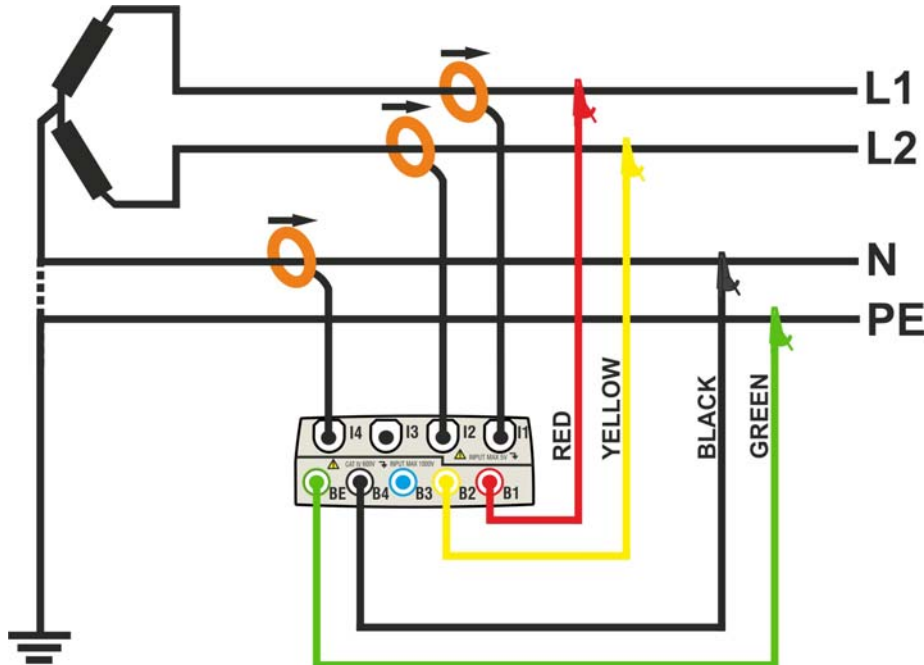

Fig. 143: Meter connection in a two phase 3-wire 3P2E system – ENG_UK type

CAUTION



If possible, before connecting the meter to the electrical equipment under test turn the power supply off.

1. Check and modify the basic settings of meter if necessary (see § 5.3.1). Set **3P 2E** system option.
2. Connect voltage test leads on Phases L1, L2, N and PE cables considering the colours as shown in Fig. 143
3. Connect the transducer current clamps on Phase L1, L2, N cables as shown in Fig. 143 respecting the clamp's arrow direction indicating the current standard sequence from generator to load. **On Real Time Values' section screens (selecting a 3 wire system preliminarily) always verify the positive value of Active Power and the power factor relative to load which should be normally inductive before starting a recording.** Reverse the clamp by 180 degrees on cables in case of negative readings.
4. Supply the electrical installation under test in case it was temporarily put out of service for meter connection. The values of parameters are shown by meter at display in Real Time Values' section (see § 5.2).
5. Press **SAVE** key if a instantaneous sample of display values (Instant) should be saved (see § 5.5). Use **HOLD** function to stopping the values at display if necessary
6. Check all settings before start a recording (see § 5.4). Press **GO/STOP** key to enable and disable a recording on meter (see § 5.4.13)

7.15. USING OF METER IN A 3 WIRE 3POY (USA SYSTEM) – ENG TYPE

CAUTION



The maximum voltage among B1, B2, B3, B4 and BE inputs is 1000V / CAT IV 600V to ground. Do not measure voltages exceeding the limits prescribed by this manual. Should you exceed the voltage limits you could damage the instrument and/or its components or endanger your safety.

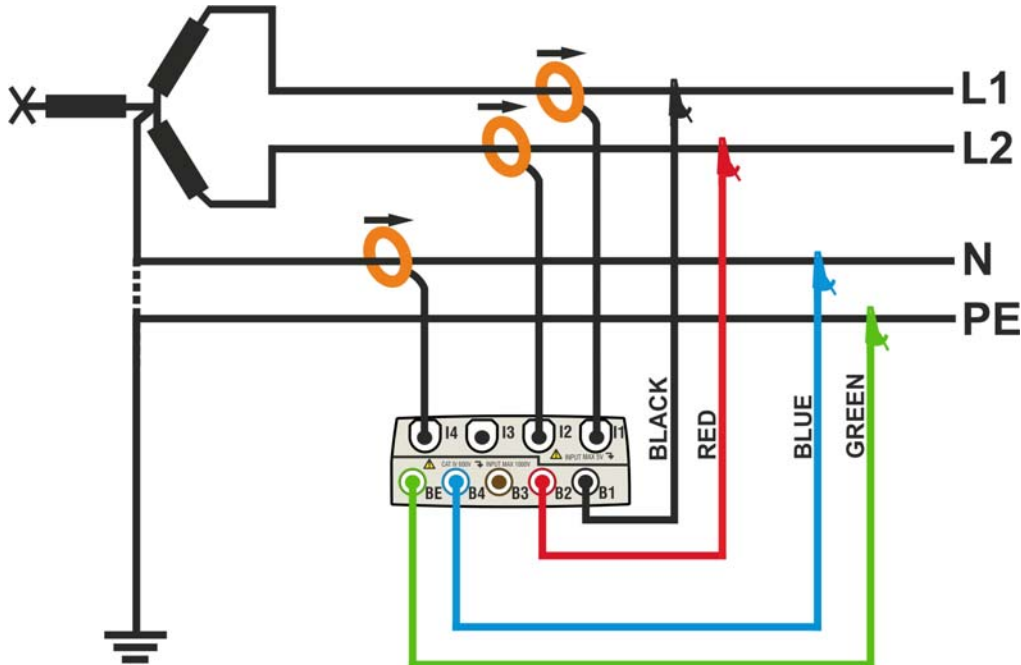

Fig. 144: Meter connection in a two phase 3-wire 3POY system – ENG type

CAUTION



If possible, before connecting the meter to the electrical equipment under test turn the power supply off.

1. Check and modify the basic settings of meter if necessary (see § 5.3.1). Set **3P OY** system option.
2. Connect voltage test leads on Phases L1, L2, N and PE cables considering the colours as shown in Fig. 144
3. Connect the transducer current clamps on Phase L1, L2, N cables as shown in Fig. 144 respecting the clamp's arrow direction indicating the current standard sequence from generator to load. **On Real Time Values' section screens (selecting a 3 wire system preliminarily) always verify the positive value of Active Power and the power factor relative to load which should be normally inductive before starting a recording.** Reverse the clamp by 180 degrees on cables in case of negative readings.
4. Supply the electrical installation under test in case it was temporarily put out of service for meter connection. The values of parameters are shown by meter at display in Real Time Values' section (see § 5.2).
5. Press **SAVE** key if a instantaneous sample of display values (Instant) should be saved (see § 5.5). Use **HOLD** function to stopping the values at display if necessary
6. Check all settings before start a recording (see § 5.4). Press **GO/STOP** key to enable and disable a recording on meter (see § 5.4.13)

7.16. USING OF METER IN A 3 WIRE 3POY (USA SYSTEM) – ENG_UK TYPE

CAUTION



The maximum voltage among B1, B2, B3, B4 and BE inputs is 1000V / CAT IV 600V to ground. Do not measure voltages exceeding the limits prescribed by this manual. Should you exceed the voltage limits you could damage the instrument and/or its components or endanger your safety.

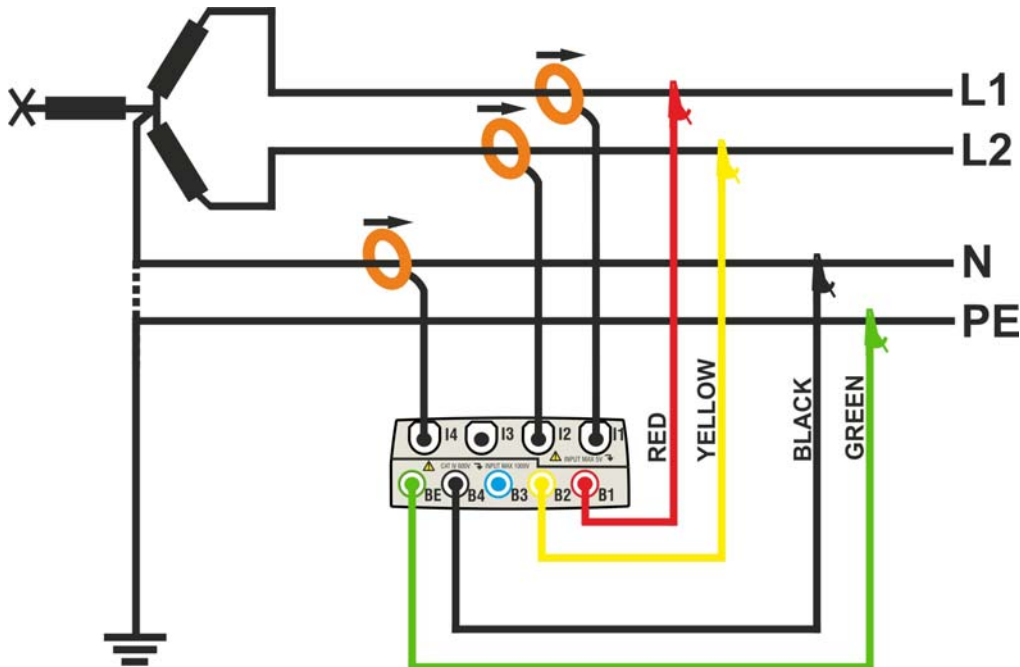

Fig. 145: Meter connection in a two phase 3-wire 3POY system – ENG_UK type

CAUTION



If possible, before connecting the meter to the electrical equipment under test turn the power supply off.

1. Check and modify the basic settings of meter if necessary (see § 5.3.1). Set **3P OY** system option.
2. Connect voltage test leads on Phases L1, L2, N and PE cables considering the colours as shown in Fig. 145
3. Connect the transducer current clamps on Phase L1, L2, N cables as shown in Fig. 145 respecting the clamp's arrow direction indicating the current standard sequence from generator to load. **On Real Time Values' section screens (selecting a 3 wire system preliminarily) always verify the positive value of Active Power and the power factor relative to load which should be normally inductive before starting a recording.** Reverse the clamp by 180 degrees on cables in case of negative readings.
4. Supply the electrical installation under test in case it was temporarily put out of service for meter connection. The values of parameters are shown by meter at display in Real Time Values' section (see § 5.2).
5. Press **SAVE** key if a instantaneous sample of display values (Instant) should be saved (see § 5.5). Use **HOLD** function to stopping the values at display if necessary
6. Check all settings before start a recording (see § 5.4). Press **GO/STOP** key to enable and disable a recording on meter (see § 5.4.13)

7.17. USING OF METER IN A 3 WIRE 1PH3W (USA SYSTEM) – ENG TYPE

CAUTION



The maximum voltage among B1, B2, B3, B4 and BE inputs is 1000V / CAT IV 600V to ground. Do not measure voltages exceeding the limits prescribed by this manual. Should you exceed the voltage limits you could damage the instrument and/or its components or endanger your safety.

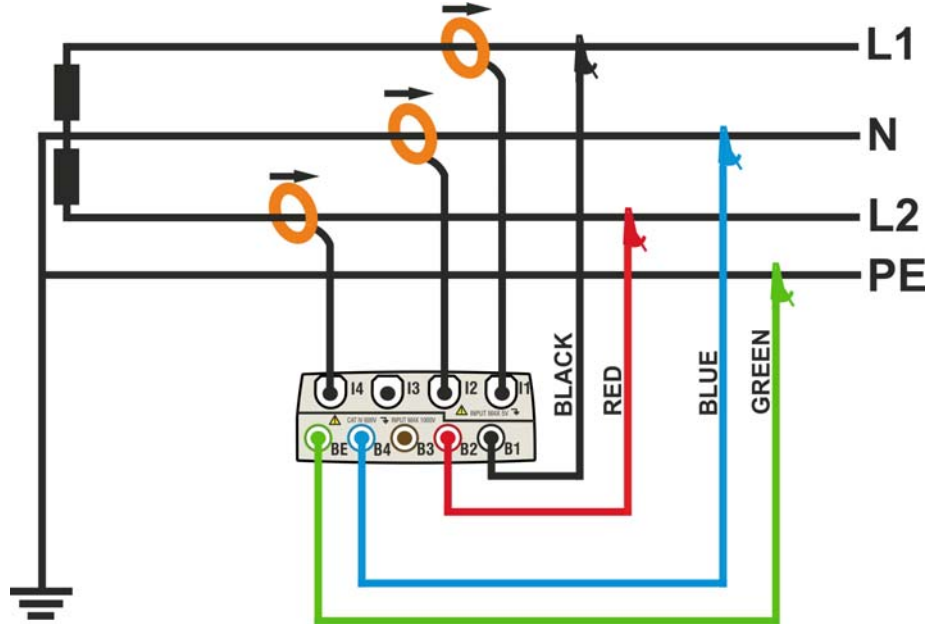

Fig. 146: Meter connection in a two phase 3-wire 1PH3W system – ENG type

CAUTION



If possible, before connecting the meter to the electrical equipment under test turn the power supply off.

1. Check and modify the basic settings of meter if necessary (see § 5.3.1). Set **1PH3W** system option.
2. Connect voltage test leads on Phases L1, L2, N and PE cables considering the colours as shown in Fig. 146
3. Connect the transducer current clamps on Phase L1, L2, N cables as shown in Fig. 146 respecting the clamp's arrow direction indicating the current standard sequence from generator to load. **On Real Time Values' section screens (selecting a 3 wire system preliminarily) always verify the positive value of Active Power and the power factor relative to load which should be normally inductive** before starting a recording. Reverse the clamp by 180 degrees on cables in case of negative readings.
4. Supply the electrical installation under test in case it was temporarily put out of service for meter connection. The values of parameters are shown by meter at display in Real Time Values' section (see § 5.2).
5. Press **SAVE** key if a instantaneous sample of display values (Instant) should be saved (see § 5.5). Use **HOLD** function to stopping the values at display if necessary
6. Check all settings before start a recording (see § 5.4). Press **GO/STOP** key to enable and disable a recording on meter (see § 5.4.13)

7.18. USING OF METER IN A 3 WIRE 1PH3W (USA SYSTEM) – ENG_UK TYPE
CAUTION

The maximum voltage among B1, B2, B3, B4 and BE inputs is 1000V / CAT IV 600V to ground. Do not measure voltages exceeding the limits prescribed by this manual. Should you exceed the voltage limits you could damage the instrument and/or its components or endanger your safety.

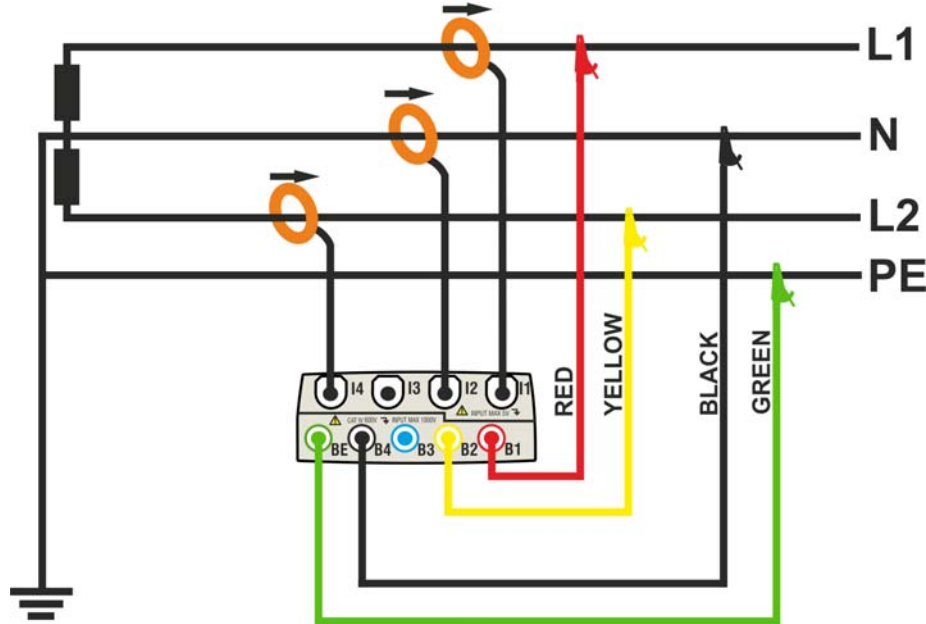

Fig. 147: Meter connection in a two phase 3-wire 1PH3W system – ENG_UK type

CAUTION

If possible, before connecting the meter to the electrical equipment under test turn the power supply off.

1. Check and modify the basic settings of meter if necessary (see § 5.3.1). Set **1PH3W** system option.
2. Connect voltage test leads on Phases L1, L2, N and PE cables considering the colours as shown in Fig. 147
3. Connect the transducer current clamps on Phase L1, L2, N cables as shown in Fig. 147 respecting the clamp's arrow direction indicating the current standard sequence from generator to load. **On Real Time Values' section screens (selecting a 3 wire system preliminarily) always verify the positive value of Active Power and the power factor relative to load which should be normally inductive** before starting a recording. Reverse the clamp by 180 degrees on cables in case of negative readings.
4. Supply the electrical installation under test in case it was temporarily put out of service for meter connection. The values of parameters are shown by meter at display in Real Time Values' section (see § 5.2).
5. Press **SAVE** key if a instantaneous sample of display values (Instant) should be saved (see § 5.5). Use **HOLD** function to stopping the values at display if necessary
6. Check all settings before start a recording (see § 5.4). Press **GO/STOP** key to enable and disable a recording on meter (see § 5.4.13)

8. MAINTENANCE

8.1. GENERAL

The PQA82x and PQA400 are precision meters. For their use and storage, follow the recommendations and instructions of this manual in order to avoid possible damages or dangers. Never use the instrument in environments with a high humidity or temperature. Do not expose the meter to direct sunlight. Always turn off the instrument after use.

8.2. SITUATIONS RELATIVE TO INTERNAL BATTERY



CAUTION

Do not open the battery cover in case for replacing of internal battery. This operation can be performed only by HT Technical Service.

The meter is powered by a rechargeable Li-ION battery with 3.7VDC output voltage which can be charged by using supplied external adapter under any function mode. The battery-adapter packet defines several combinations which are shown through different icon in the top right display as follows:

Icon at display	Description
	Too low battery level. Perform a battery charging
	Residual battery charging at 25%
	Residual battery charging at 50%
	Residual battery charging at 75%
	Battery fully charged
	Only adapter connected. Battery disconnected
	Battery and adapter connected. Recharging battery
	Battery fully charged with adapter connected
	Battery charge unknown. Connect adapter
	Problem with battery. Contact HT Technical Service

Table 10: List of battery icons at display

8.3. CLEANING

Use a soft dry cloth to clean the meter. Do not use never wet clothes, solvents, water etc.. and take particular care at TFT display.

8.4. END OF LIFE



CAUTION: This symbol indicates that equipment and its accessories shall be subject to a separate collection and correct disposal.

9. TECHNICAL SPECIFICATIONS

9.1. TECHNICAL FEATURES

TRMS AC/DC Voltage Phase-Neutral / Phase-Ground – Single phase / Three phase systems

Range	Accuracy	Resolution	Input impedance
0.0 ÷ 600.0V	$\pm(0.5\%rdg+2dgt)$	0.1V	10M Ω

Max crest factor = 2

Voltage values < 2.0V are considered zero by meter

Meter is connectable with external VT with ratio selectable from 1 ÷ 3000

TRMS AC/DC Voltage Phase-Phase – Three phase systems

Range	Accuracy	Resolution	Input impedance
0.0 ÷ 1000.0V	$\pm(0.5\%rdg+2dgt)$	0.1V	10M Ω

Max crest factor = 2

Voltage values < 2.0V are considered zero by meter

Meter is connectable with external VT with ratio selectable from 1 ÷ 3000

Voltage Anomalies Phase-Neutral – Single phase / Three phase 4-wire systems

Range	Voltage Accuracy	Time Accuracy (50Hz)	Voltage Resolution	Time Resolution (50Hz)
0.0 ÷ 600.0V	$\pm(1.0\%rdg+2dgt)$	$\pm 10ms$	0.2V	10ms

Max crest factor = 2

Voltage values < 2.0V are considered zero by meter

Meter is connectable with external VT with ratio selectable from 1 ÷ 3000

Selectable threshold from $\pm 1\%$ to $\pm 30\%$

Voltage Anomalies Phase-Phase – Three phase 3-wire systems

Range	Voltage Accuracy	Time Accuracy (50Hz)	Voltage Resolution	Time Resolution (50Hz)
0.0 ÷ 1000.0V	$\pm(1.0\%rdg+2dgt)$	$\pm 10ms$	0.2V	10ms

Max crest factor = 2

Voltage values < 2.0V are considered zero by meter

Meter is connectable with external VT with ratio selectable from 1 ÷ 3000

Selectable threshold from $\pm 1\%$ to $\pm 30\%$

Voltage Spikes – Phase-Ground - Single phase and Three phase systems (only PQA824)

Range	Voltage Accuracy	Voltage Resolution	Time resolution (50Hz)	Detection time (50Hz)
-1000V ÷ 100V	$\pm(2.0\%rdg+60V)$	1V	$\pm 10ms$	78 μs – 2.5ms (SLOW)
100V ÷ 1000V				
-6000V ÷ -100V	$\pm(10\%rdg+100V)$	15V	$\pm 10ms$	5 μs – 160 μs (FAST)
100V ÷ 6000V				

Voltage detection threshold set from 100V ÷ 5000V

Maximum number of recorded events: 20000

TRMS AC Current with Standard STD transducer clamp

Range	Accuracy	Resolution	Input impedance	Overload protection
0.0 ÷ 1000.0mA	$\pm(0.5\%rdg+0.06\%FS)$	0.1mA	510k Ω	5V

Measure performed with voltage output =1VAC with nominal current measured by clamp

Max crest factor = 3

Current values < 0.1% of full scale (FS) are considered zero by meter

TRMS AC Current with Flex transducer clamp – Range 300A

Range	Accuracy	Resolution	Input impedance	Overload protection
0.0 ÷ 49.9A	$\pm(0.5\%rdg+0.24\%FS)$	0.1A	510k Ω	5V
50.0 ÷ 300.0A	$\pm(0.5\%rdg+0.06\%FS)$			

Measurements performed with HTFLEX33 flexible clamp

Max crest factor = 3

Current values < 1A are considered zero by meter

TRMS AC Current with Flex transducer clamp – Range 3000A

Range (*)	Accuracy	Resolution	Input impedance	Overload protection
0.0 ÷ 3000.0A	$\pm(0.5\%rdg+0.06\%FS)$	0.1A	510k Ω	5V

Measurements performed with HTFLEX33 flexible clamp

Max crest factor = 3

Current values < 5A are considered zero by meter

Inrush Current (only PQA82x)

Range	Accuracy	Resolution	Time resolution (50Hz)	Time accuracy (50Hz)
Depending on clamp type	$\pm(1.0\%rdg+0.4\%FS)$	Depending on clamp type	10ms	$\pm 10ms$

Max crest factor = 3

Maximum number of recorded events: 1000

Power – Single phase / Three phase systems (@ $\text{Cos}\phi > 0.5$ and $V_{mis} > 60V$, clamp type STD)

Parameter [W, VAR, VA]	Full Scale Clamp (FS)	Range [W, VAR, VA]	Accuracy	Resolution [W, VAR, VA]
Active Power Reactive Power Apparent Power	$FS \leq 1A$	0.0 ÷ 999.9 1.000 ÷ 9.999k	$\pm(1.0\%rdg+6dgt)$	0.1 0.001k
	$1A < FS \leq 10A$	0.000 ÷ 9.999k 10.00 ÷ 99.99k		0.001k 0.01k
	$10A < FS \leq 100A$	0.00 ÷ 99.99k 100.0 ÷ 999.9k		0.01k 0.1k
	$100A < FS \leq 3000A$	0.0 ÷ 999.9k 1.000 ÷ 9.999M		0.1k 0.001M

For STD clamp

 V_{mis} = voltage correspondent to power measurement

FS = Full scale clamp

Energy – Single phase / Three phase systems (@ $\text{Cos}\phi > 0.5$ and $V_{mis} > 60V$, clamp type STD)

Parameter [Wh, VARh, VAh]	Full Scale Clamp (FS)	Range [Wh, VARh, VAh]	Accuracy	Resolution [Wh, VARh, VAh]
Active Energy Reactive Energy Apparent Energy	$FS \leq 1A$	0.0 ÷ 999.9 1.000 ÷ 9.999k	$\pm(1.0\%rdg+6dgt)$	0.1 0.001k
	$1A < FS \leq 10A$	0.000 ÷ 9.999k 10.00 ÷ 99.99k		0.001k 0.01k
	$10A < FS \leq 100A$	0.00 ÷ 99.99k 100.0 ÷ 999.9k		0.01k 0.1k
	$100A < FS \leq 3000A$	0.0 ÷ 999.9k 1.000 ÷ 9.999M		0.1k 0.001M

For STD clamp

 V_{mis} = voltage correspondent to power measurement

FS = Full scale clamp

Power Factor ($\text{Cos}\phi$) – Single phase / Three phase systems

Range	Accuracy (°)	Resolution (°)
0.20÷0.50	1.0	0.01
0.50÷0.80	0.7	
0.80÷1.00	0.6	

Voltage / Current harmonics

Range	Accuracy(*)	Resolution
DC ÷ 25 ^a	$\pm(5.0\%rdg+5dgt)$	0.1V / 0.1A
26 ^a ÷ 33 ^a		
34 ^a ÷ 49 ^a		

(*) Accuracy to add at correspondent TRMS paramters

Frequency

Range	Accuracy	Resolution
42.5÷69.0Hz	$\pm(0.2\%rdg+1dgt)$	0.1Hz

Flicker – Single phase / Three phase systems (only PQA82x)

Parameter	Range	Accuracy	Resolution
Pst1', Pst	0.0÷10.0	compliance to IEC/EN61000-4-15	0.1
Plt			

9.2. GENERAL FEATURES

Real time values

General network parameters:	Voltages, Currents, Powers, Cos ϕ Flicker, Unbalance, THD%, Harmonics
Signals waveforms:	Voltages, Currents, harmonics histograms
Vectorial diagrams:	Voltages, Currents

Recordings

Parameters:	Each general parameters + energies
Number of selectable parameter:	Max 251
Integration period:	1, 2, 5, 10, 30sec, 1, 2, 5, 10, 15, 30, 60min
Recording time:	>3 months with 251 parameters@15min

Display

Characteristics:	Graphic TFT with backlight, 1/4 " VGA (320x240pxls)
Touch screen:	Yes
Number of colours:	65536
Brightness adjustment:	Programmable

Operative system and memory

Operative system:	Windows CE
Internal memory:	About 15Mbytes (about 32Mbytes with Compact Flash)
PC interface:	USB

Power supply

Internal power supply:	Rechargeable battery, autonomy >6 hours
External power supply:	Adapter 230VAC / 5V DC
Auto power OFF:	After 5min of no use (without external adapter)

Mechanical characteristics

Dimensions:	235(L) x 165(W) x 75(H)
Weight (included battery):	About 1.0kg

Reference standards

Safety of meter:	IEC/EN61010-1
Technical literature:	IEC/EN61187
Safety standard accessories:	IEC/EN61010-031, IEC/EN61010-2-032
Insulation:	Double insulation
Pollution degree:	2
Max altitude:	2000m
Overvoltage category:	CAT IV 600V to Ground, max 1000V between inputs
Power Quality:	EN50160
Quality of electrical power:	IEC/EN61000-4-30 class B
Flicker:	IEC/EN61000-4-15
Unbalance:	IEC/EN61000-4-7, EN50160

9.3. ENVIRONMENT

9.3.1. Climatic condition

Reference calibration temperature:	23 \pm 5°C
Working temperature:	0 \div 40°C
Relative humidity:	<80%HR
Storage temperature:	-10 \div 60°C
Storage relative humidity to:	<80%HR

This instrument complies with the prescriptions of the European directive on low voltage 2014/35/CE (LVD) and EMC 2014/30/CE

9.4. ACCESSORIES

Use only the optional accessories indicated in the enclosed packing list.

10. APPENDIX – THEORETICAL OUTLINES

10.1. VOLTAGE ANOMALIES

The meter is capable of recording all those TRMS values as voltage anomalies, calculated every 10ms, beyond the percentage thresholds of Voltage Reference (Vref) set during the programming from $\pm 1\%$ to $\pm 30\%$ with steps of 1%. These limits remain unchanged throughout the recording period.

The reference are set to:

Nominal Voltage Phase to Neutral: For Single Phase and 4 wires three phase system.

Nominal Voltage Phase to Phase: For 3 wires three phase system.

Example1: Three Phase System 3 wires.

Vref = 400V, LIM+= 6%, LIM-=10% =>

High Lim = $400 \times (1+6/100) = 424,0V$

Low Lim = $400 \times (1-10/100) = 360$

Example2: Three Phase System 4 wires.

Vref = 230V, LIM+= 6%, LIM-=10% =>

High Lim = $230 \times (1+6/100) = 243,08V$

Low Lim = $230 \times (1-10/100) = 207,0V$

For each voltage anomaly the instrument records:

- The number corresponding to the phase where the anomaly occurred.
- The “direction” of the anomaly: “UP” and “DN” identify voltage drops (sag) and peaks (swell) respectively.
- The date and time of the event beginning in the form day, month, year, hour, minutes, seconds, hundredths of second.
- The duration of the event, in seconds with a resolution of 10ms.
- The minimum (or maximum) value of voltage during the event.

10.2. VOLTAGE AND CURRENT HARMONICS

10.2.1. Theory

Any periodical no-sine wave can be represented as a sum of sinusoidal waves having each a frequency that corresponds to an entire multiple of the fundamental, according to the relation:

$$v(t) = V_0 + \sum_{k=1}^{\infty} V_k \sin(\omega_k t + \varphi_k) \quad (1)$$

where:

V_0 = Average value of $v(t)$.

V_1 = Amplitude of the fundamental of $v(t)$.

V_k = Amplitude of the k^{th} harmonic of $v(t)$.

In the mains voltage, the fundamental has a frequency of 50 Hz, the second harmonic has a frequency of 100 Hz, the third harmonic has a frequency of 150 Hz and so on. Harmonic distortion is a constant problem and should not be confused with short events such as sags, swells or fluctuations.

It can be noted that in (1) the index of the sigma is from 1 to the infinite. What happens in reality is that a signal does not have an unlimited number of harmonics: a number always exists after which the harmonics value is negligible.

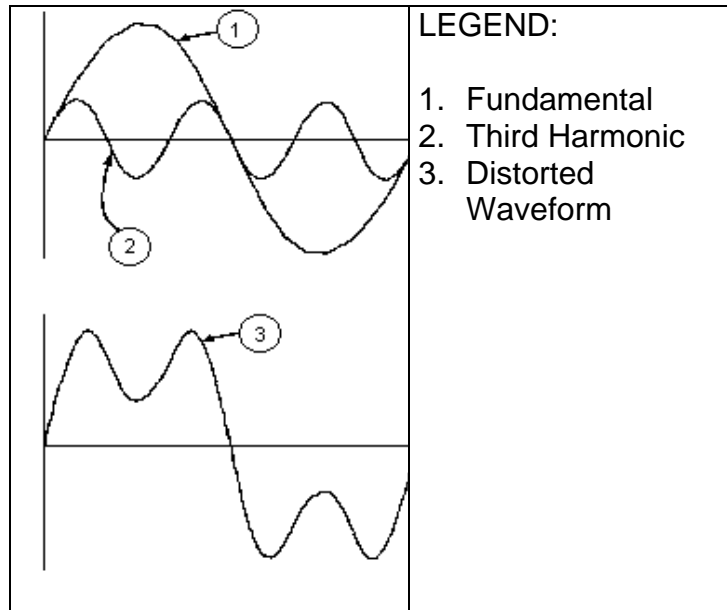

Effect of the sum of 2 multiple frequencies

The EN50160 standard recommends to stop the index in the expression (1) corresponding to the 40th harmonic. A fundamental element to detect the presence of harmonics is THD defined as:

$$THDV\% = \frac{\sqrt{\sum_{h=2}^{40} V_h^2}}{V_1} \times 100$$

This index takes all the harmonics into account. The higher it is, the more distorted the waveform results.

10.2.2. Limit values for harmonic voltage

EN50160 standard fixes the limits for the harmonic voltages, which can be introduced into the network by the power supplier. In normal conditions, during any period in a week, 95% of the RMS values of each harmonic voltage, mediated on 10 minutes, shall be lower than or equal to the values stated in the following table. The total harmonic distortion (THD) of the supply voltage (including all the harmonics up to 40th order) must be lower than or equal to 8%.

ODD HARMONICS				EVEN HARMONICS	
Not multiple of 3		Multiple of 3		Order h	Relative voltage %Max
Order h	Relative voltage % Max	Order h	Relative voltage % Max		
5	6	3	5	2	2
7	5	9	1,5	4	1
11	3,5	15	0,5	6..24	0,5
13	3	21	0,5		
17	2				
19	1,5				
23	1,5				
25	1,5				

Table 11: Reference values for harmonics voltage in compliance to EN50160

These limits, theoretically applicable only for the suppliers of electric energy, provide anyway a series of reference values within which the harmonics introduced into the network by the users must be contained.

10.2.3. Presence of harmonics: causes

Any apparatus that alters the sine wave or uses only a part of such a wave causes distortions to the sine wave and therefore harmonics.

All current signals result in some way virtually distorted. The most common situation is the harmonic distortion caused by no-linear loads such as electric household appliances, personal computers or speed control units for motors. Harmonic distortion causes significant currents at frequencies that are odd multiples of the fundamental frequency. Harmonic currents affect considerably the neutral wire of electric installations.

In most countries, the mains power is three-phase 50/60Hz with a delta primary and star secondary transformers. The secondary generally provides 230V AC from phase to neutral and 400V AC from phase to phase. Balancing the loads on each phase has always represented an headache for electric system designers.

Tracing back to ten years ago, in a well balanced system, the vectorial sum of the currents in the neutral was zero or quite low (in view of the difficulty to get a perfect balance). The devices were incandescent lights, small motors and other devices that presented linear loads. The result was an essentially sinusoidal current in each phase and a low current on the neutral at a frequency of 50/60Hz.

“Modern” devices such as TV sets, fluorescent lights, video machines and microwave ovens normally draw current for only a fraction of each cycle thus causing non-linear loads and subsequent non-linear currents. All this generates odd harmonics of the 50/60Hz line frequency. For this reason, the current in the transformers of the distribution boxes contains only a 50Hz (or 60Hz) component but also a 150Hz (or 180Hz) component, a 50Hz (or 300Hz) component and other significant components of harmonic up to 750Hz (or 900Hz) and higher.

The vectorial sum of the currents in a well balanced system that feeds no-linear loads may still be quite low. However, the sum does not eliminate all current harmonics. The odd multiples of the third harmonic (called “TRIPLENS”) are added together in the neutral and can cause overheating even with balanced loads.

10.2.4. Presence of harmonics: consequences

In general, even harmonics, i.e. the 2nd, 4th etc., do not cause problems. Triple harmonics, odd multiples of three, are added on the neutral (instead of deleting each other) thus creating a condition of overheating of the wire which is extremely dangerous.

Designers should take into consideration the three issues given below when designing a power distribution system that will contain harmonic current:

- The neutral wire must be of sufficient gauge.
- The distribution transformer must have an additional cooling system to continue operating at its rated capacity when not suited to the harmonics. This is necessary because the harmonic current in the neutral wire of the secondary circuit circulates in the delta-connected primary circuit. This circulating harmonic current heats up the transformer.
- Phase harmonic currents are reflected on the primary circuit and continue back to the power source. This can cause distortion of the voltage wave so that any power factor correction capacitors on the line can be easily overloaded.

The 5th and the 11th harmonic contrast the current flow through the motors making its operation harder and shortening their average life.

In general, the higher the ordinal harmonic number, the smaller its energy is and therefore its impact on the devices (except for transformers).

10.3. INRUSH CURRENTS (ONLY PQA82X)

The PQA82x meters permits the real time detection of inrush current events, typical of start-up of electrical machines and also for other industrial applications (e.g. troubleshooting problem regarding loads switching, correct calculation of protection devices, oscillating currents, etc...) as shown in the following pictures:

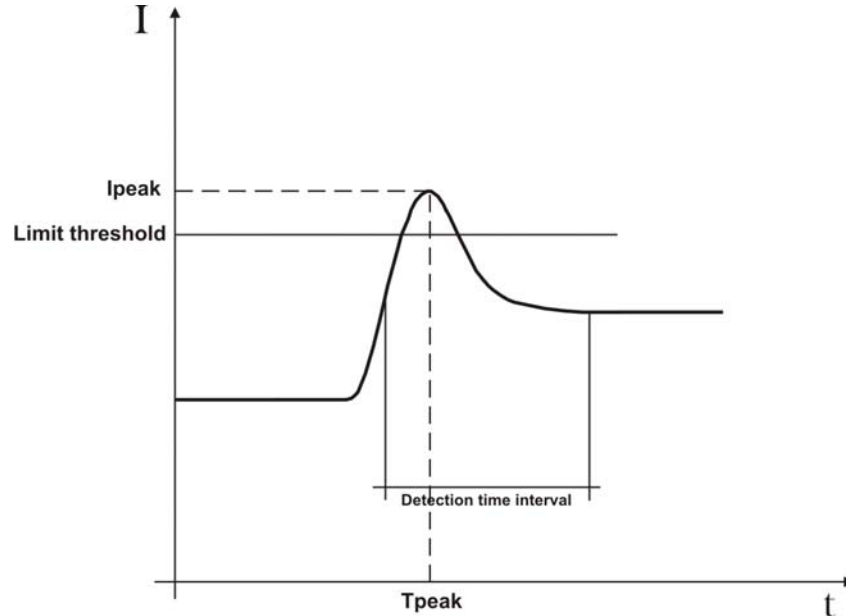

Fig. 148: Parameters of standard inrush current event

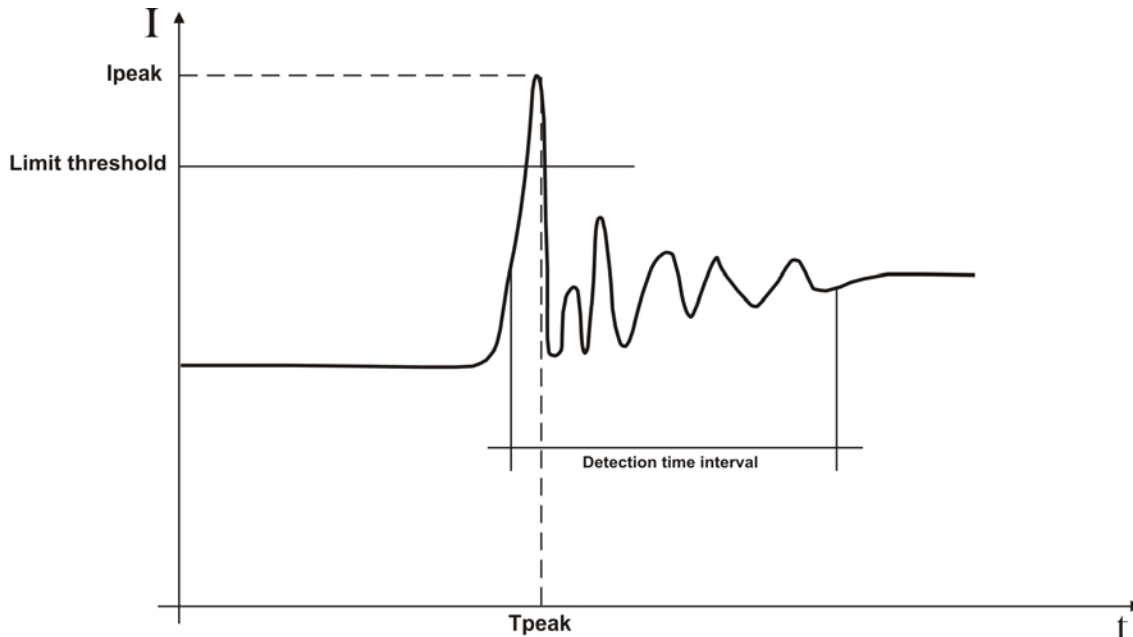

Fig. 149: Parameters of oscillating inrush current event

The meter detect and recording as inrush current all the events where the phase currents TRMS values are over a set limit threshold. The maximum number of recorded events is fixed to **1000**.

During setting operation before recording start the user can be modify the below parameters:

- **Current limit threshold:** Current value of detection and recording of the event. The maximum set value of this parameter is always equal to the full scale of used transducer clamps.

- **Detectable modes :** The below modes are available and selectable:
- FIX:** The meter detect and recording a event each time the TRMS value of current, calculated on each half period (10ms @ 50Hz, 8.3ms @ 60Hz), it's over the limit threshold defined by user. **A new event is detected by meter always if the current value decrease under the set limit threshold.**
 - VAR:** The meter detect and recording a event each time the TRMS value of current, calculated on each half period (10ms @ 50Hz, 8.3ms @ 60Hz), it's over of the previous TRMS value (calculated in previous half period) of a difference defined by the limit threshold defined by user.
- **Detectable time interval:** As soon as the meter detect a event, it's recording 100 TRMS value of current and 100 TRMS value of the correspondent voltage within the detectable time interval set by user. The available values are **1s, 2s, 3s, 4s.**

The PQA82x meter shows at display the number of detectable events during the recording. The analysis of results is only possible downloading the saved data to PC and using the standard TopView software. In particular the below parameters are shown:

- **Table of recorded events** (phase where the event is occurred, date/time when the event is occurred, maximum value between TRMS values calculated in a half period during the detectable time interval, value of last sample at the end of the detectable time interval).
- **Graphical window of recorded events** (graphic of saved 100 TRMS values of current and correspondent voltage during the detectable time interval for each row of the table of recorded events).

For any detail about saved data please refer to TopView HELP ON LINE feature.

10.4. FLICKER

Considering the theoretical definition, **Flicker** is due to an abnormal variations of voltage supply, in particular relative to its RMS value as the luminescence of a traditional light is a direct consequence. This effect should be monitoring in compliance with IEC/EN61000-4-15 guideline.

Main causes of this disturbance are typically due to discontinuous switching of big loads which are connected to electrical network (e.g. furnaces, foundries, arc welders for industrial use).

Electrical suppliers should satisfy severe regulations regarding this kind of disturbance. With suitable meters, called *flicker meters*, it's possible to get a ratio between a distort signal and an ideal signal and perform a statistics analysis relative to calculation of the following parameters whose values **must be always <1**:

Pst = Short term severity of Flicker calculated in an interval of 10 minutes.

Plt = Long term severity of Flicker calculated considering a sequence of 12 values of Pst in an interval of two hours according to the following formula:

$$P_{lt} = \sqrt[3]{\sum_{i=1}^{12} \frac{P_{sti}^3}{12}}$$

10.5. SUPPLY VOLTAGE UNBALANCE

In normal conditions the supply voltage and the final loads are perfectly balanced. Unbalances are possible in trouble situations (low insulation) and/or phase circuits interruptions. Moreover, in single phase systems, the balance can be only statistic.

In order to design a correct protection installation a thorough study of anomalous conditions on three phase systems was performed. To better understand the meaning of an installation's parameter the theory of symmetric components is fundamental.

From the theory is always true that any tern of vectors can be decomposed in three kind of tern: the direct (positive) symmetric tern, the reversed (negative) symmetric tern and the omopolar (zero) tern as shown in below picture:

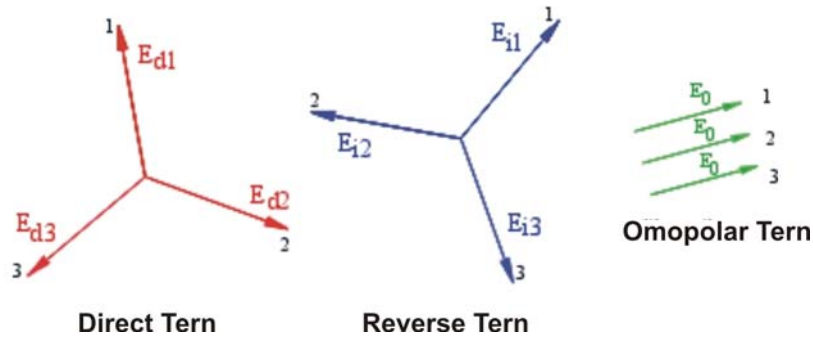

Fig. 150: Decomposition of a vectors tern

On the base of this the result is that each unbalanced three phase system can be decomposed in 3 three phase systems which can be reduced to a separate study of three single phase circuits relative to **direct sequence**, **negative sequence** and **zero sequence** respectively.

The EN50160 standard it declares, relative to low voltage systems that “*under normal operating conditions, during each period of one week, 95% of the 10 minute mean rms values of the negative phase sequence component of the supply voltage shall be within the range 0 to 2% of the direct phase sequence component. In some areas with partly single phase or two phase connected customers’ installations, unbalanced up to about 3% at three phase supply terminal occur.*” The meter permits the measure and recording of below parameters, which are characteristics of unbalanced degree of an installations:

$$NEG\% = \frac{E_r}{E_d} \times 100 = \text{component at negative sequence}$$

$$ZERO\% = \frac{E_0}{E_d} \times 100 = \text{component at zero sequence}$$

where:

E_r = sequence of negative tern.

E_d = sequence of direct tern.

E_0 = sequence of zero tern.

10.6. VOLTAGE FAST TRANSIENTS (SPIKES) (ONLY PQA824)

The meter considers all the phenomena associated to the phase voltage as voltage spikes which have the following properties:

- **Fast slope variations of voltage waveforms.**
- **Exceeding a limit threshold fixed by user before starting a recording.**

The maximum number of recorded events in a half period (10ms @ 50Hz, 8.3ms @ 60Hz) is **4**. The maximum number of recorded events by meter during a recording is **20000**.

To better understand the features of this analysis refer to the following picture where a typical voltage spike at 50Hz frequency is shown:

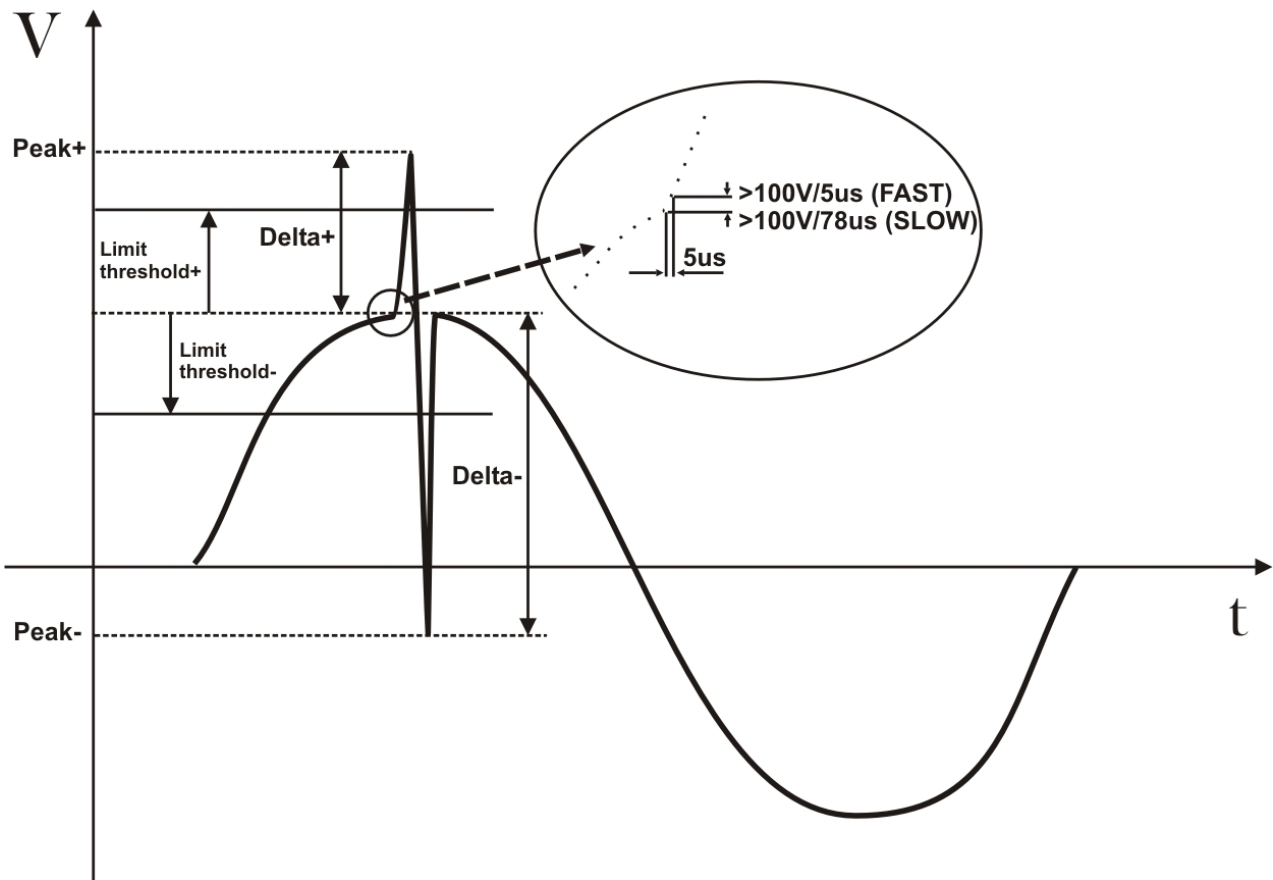

Fig. 151: Typical voltage spikes at 50Hz frequency

The meter continuously checks the input voltage signals performing 2 simultaneous routines with different sampling rates. In particular:

- **SLOW:** The signals of input voltage are sampled with a 256 samples/period rate (20ms @ 50Hz, 16.7ms @ 60Hz).
- **FAST:** The signals of input voltage are sampled at 200kHz frequency.

As soon as an event occurs, the meter automatically checks whether one of the following conditions are respected:

- $dV/dt > 100V/5\mu s \rightarrow$ type of event **FAST**.
- $dV/dt > 100V/78\mu s \rightarrow$ type of event **SLOW @ 50Hz**.
- $dV/dt > 100V/65\mu s \rightarrow$ type of event **SLOW @ 60Hz**.

and that during the **detectable time interval** defined as:

- $32 \times 5\mu\text{s} = 160\mu\text{s}$.
- $32 \times 78\mu\text{s} = 2.5\text{ms}$.
- $32 \times 65\mu\text{s} = 2.1\text{ms}$.

the positive and negative difference (defined **DELTA+** and **DELTA-** respectively) it's over the "windows" defined by the limit threshold set by user.

Based to the above description, downloading the saved data from meter to PC using the standard TopView software, the below parameters are shown:

- **Num. Tot** → Total number of recorded events.
- **Limit** → Voltage value threshold defined by user which permits the recording of a event.
- **Phase** → ID of phase where the event is occurred.
- **Date/Time** → Date/Hour in minutes, seconds, cents per second when the event is occurred.
- **Up/Down** → This flag is **UP** if the spike is correspondent to a rising edge and is **DOWN** if the spike is correspondent to a falling edge.
- **PEAK+** → Max positive value reached from spike during the detectable time interval.
- **PEAK-** → Mix negative value reached from spike during the detectable time interval.
- **DELTA+** → Max positive relative difference reached from spike during the detectable time interval.
- **DELTA-** → Min negative relative difference reached from spike during the detectable time interval.
- **F/S** → Type of event (F = FAST, S = SLOW).

For any detail about saved data please refer to TopView HELP ON LINE feature.

10.7. POWER AND POWER FACTOR: DEFINITIONS

In a standard electrical installation powered by three sine voltages the following are to be defined:

Phase Active Power:	(n=1,2,3)	$P_{actn} = V_{nN} \cdot I_n \cdot \cos(\varphi_n)$
Phase Apparent Power:	(n=1,2,3)	$P_{appn} = V_{nN} \cdot I_n$
Phase Reactive Power:	(n=1,2,3)	$P_{reactn} = \sqrt{P_{appn}^2 - P_{actn}^2}$
Phase Power Factor:	(n=1,2,3)	$P_{Fn} = \frac{P_{actn}}{P_{appn}}$
Total Active Power:		$P_{act} = P_{act1} + P_{act2} + P_{act3}$
Total Reactive Power:		$P_{react} = P_{react1} + P_{react2} + P_{react3}$
Total Apparent Power:		$P_{app} = \sqrt{P_{act}^2 + P_{react}^2}$
Total Power Factor:		$P_F = \frac{P_{act}}{P_{app}}$

where:

V_{nN} = RMS value of voltage between phase n and Neutral.

I_n = RMS value of n phase current.

φ_n = Phase angle between voltage and current of n phase.

In the presence of distorted voltages and currents the previous relations vary as follows:

Phase Active Power:	(n=1,2,3)	$P_{actn} = \sum_{k=0}^{\infty} V_{kn} I_{kn} \cos(\varphi_{kn})$
Phase Apparent Power:	(n=1,2,3)	$P_{appn} = V_{nN} \cdot I_n$
Phase Reactive Power:	(n=1,2,3)	$P_{reactn} = \sqrt{P_{appn}^2 - P_{actn}^2}$
Phase Power Factor:	(n=1,2,3)	$P_{Fn} = \frac{P_{actn}}{P_{appn}}$
Distorted Power Factor	(n=1,2,3)	$dPF_n = \cos \varphi_{1n}$ = phase displacement between the fundamentals of voltage and current of n phase
Total Active Power:		$P_{act} = P_{act1} + P_{act2} + P_{act3}$
Total Reactive Power:		$P_{react} = P_{react1} + P_{react2} + P_{react3}$
Total Apparent Power:		$P_{app} = \sqrt{P_{act}^2 + P_{react}^2}$
Total Power Factor:		$P_F = \frac{P_{act}}{P_{app}}$

where:

V_{kn} = RMS value of kth voltage harmonic between n phase and Neutral.

I_{kn} = RMS value of kth current harmonic of n phase.

φ_{kn} = Phase displacement angle between kth voltage harmonic and kth current harmonic of n phase.

Note:

It shall be noted that the expression of the phase Reactive Power with no sine waveforms, would be wrong. To understand this, it may be useful to consider that both the presence of harmonics and the presence of reactive power produce, among other effects, an increase of line power losses due to the increased current RMS value. With the above given relation the increasing of power losses due to harmonics is added to that introduced by the presence of reactive power. In effect, even if the two phenomena contribute together to the increase of power losses in line, it is not true generally that these causes of power losses are in phase between each other and therefore that can be summed mathematically.

The above given relation is justified by the relative simplicity of its calculation and by the relative discrepancy between the value obtained using this relation and the true value.

It shall also be noted, how, in case of an electric installation with harmonics, another parameter called distorted Power Factor (Cosphi) is defined. In practice, this parameter represents the theoretical limit value that can be reached for Power Factor if all the harmonics could be eliminated from the electric installation.

10.7.1. Conventions on powers and power factors

As for the recognition of the type of reactive power, of the type of power factor and of the direction of the active power, the below conventions must be applied. The stated angles are those of phase-displacement of the current compared to the voltage (for example, in the first panel the current is in advance from 0° to 90° compared to the voltage):

Equipment under test = Inductive Generator ←	90°	→ Equipment under test = Capacitive Load
Pact + = 0 Pact - = Pact Pfc + = -1 Pfc - = -1 Pfi + = -1 Pfi - = Pf PreactC + = 0 PreactC - = 0 Preacti + = 0 Preacti - = Preact		Pact + = Pact Pact - = 0 Pfc + = Pf Pfc - = -1 Pfi + = -1 Pfi - = -1 PreactC + = Q PreactC - = 0 Preacti + = 0 Preacti - = 0
180°		0°
Pact + = 0 Pact - = Pact Pfc + = -1 Pfc - = Pf Pfi + = -1 Pfi - = -1 PreactC + = 0 PreactC - = Preact Preacti + = 0 Preacti - = 0		Pact + = Pact Pact - = 0 Pfc + = -1 Pfc - = -1 Pfi + = Pf Pfi - = -1 PreactC + = 0 PreactC - = 0 Preacti + = Preact Preacti - = 0
	270°	
Equipment under test = Capacitive Generator ←		→ Equipment under test = Inductive Load

where:

Symbol	Description	Remarks
Pact+	Value of the active power +	Positive parameter (user)
Pfc+	Capacitive power factor +	
Pfi+	Inductive power factor +	
Preactc+	Value of the capacitive reactive power +	
Preacti+	Value of the inductive reactive power +	
Pact-	Value of the active power -	Negative parameter (generator)
Pfc-	Capacitive power factor -	
Pfi-	Inductive power factor -	
Preactc-	Value of the capacitive reactive power -	
Preacti-	Value of the inductive reactive power -	

Value	Description
Pact	The active power (positive or negative) is defined in the panel and therefore acquires the value of the active power in that moment.
Preact	The reactive power (inductive or capacitive, positive or negative) is defined in the panel and therefore acquires the value of the reactive power in that moment.
Pf	The power factor (inductive or capacitive, positive or negative) is defined in the panel and therefore acquires the value of the power factor in that moment.
0	The active power (positive or negative) or the reactive power (inductive or capacitive, positive or negative) is NOT defined in the panel and therefore acquires a null value.
-1	The power factor (inductive or capacitive, positive or negative) is NOT defined in the panel.

10.7.2. Three phase 3 wire ARON system

In the electrical systems distributed without neutral, the phase voltages and the power factors and phase $\cos\phi$ lose importance. Only the phase to phase voltages, the phase currents and the total powers remain defined.

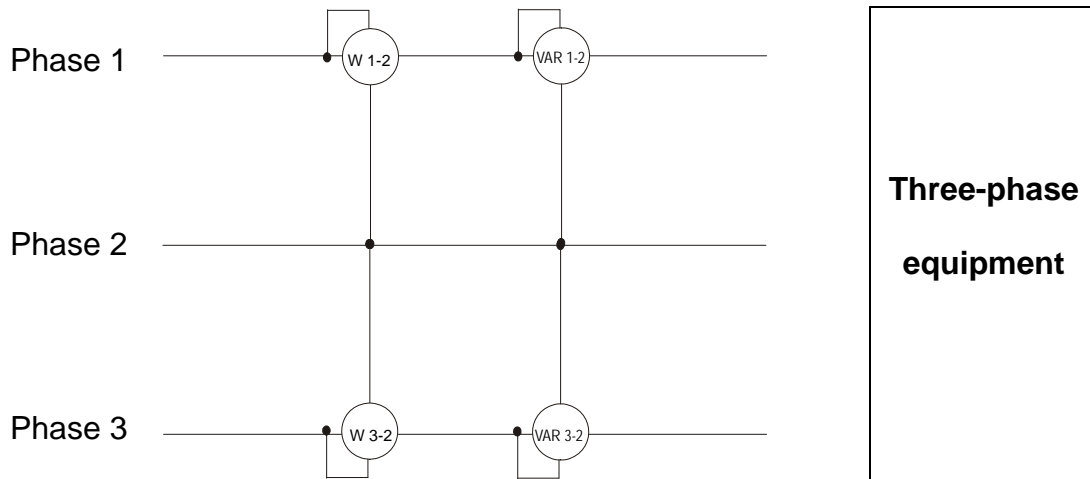

In this case the potential of one of the three phases (for example, phase 2) is taken on as reference potential. The total values of the active, reactive and apparent power are expressed as sum of the indications of the couples of Wattmeters, VARmeters and VAmeters.

$$P_{act} = P_{act12} + P_{act32}$$

$$P_{react} = P_{react12} + P_{react32}$$

$$P_{app} = \sqrt{(P_{act12} + P_{act32})^2 + (P_{react12} + P_{react32})^2}$$

10.8. MEASURING METHOD: OUTLINES

The meter is capable of measuring: voltages, currents, active powers, inductive and capacitive reactive powers, apparent powers, inductive and capacitive power factors, energies, analogical or pulse parameters. All these parameters are analysed in a digital way for each phase (voltage and current) and calculated based on formulas of the previous sections.

10.8.1. Integration period

The storage of all the data would require a huge memory capacity. Therefore we've tried to find out a storage method which permits to compress the information to be saved providing significant data.

The selected method is the integration one: after a certain period called "**integration period**", which can be set from **1 seconds to 60 minutes**, the meter extracts from the sampled values the following values:

- MINIMUM value of the parameter during the integration period (harmonics excluded).
- AVERAGE value of the parameter (intended as arithmetic average of all the values recorded during the integration period).
- MAXIMUM value of the parameter during the integration period (harmonics excluded).

Only this information (repeated for each parameter to be stored) are saved in the memory along with starting time and date of the integration period.

Once these data are stored, the instrument restarts to take measurements for a new period.

10.8.2. Power factor calculations

According to the standards in force, the medium power factor cannot be calculated as average of the instantaneous power factors. It must be obtained from the medium values of active and reactive power.

Each single medium power factor (of phase or total) is therefore calculated, at the end of each integration period, on the medium value of the corresponding powers independently of the fact that they must be registered or not.

Besides, for a better analysis of the type of load present on the line and in order to get reference terms in the invoicing analysis of the low $\cos\phi$, the values of inductive and capacitive $\cos\phi$ are treated as independent parameters.

11. AFTER-SALE SERVICE

11.1. WARRANTY

This instrument is guaranteed against any defects in material and manufacturing, in compliance with the general sale terms and conditions. During the warranty period all defective parts may be replaced, but the manufacturer reserves the right to repair or replace the product.

If the instrument is to be returned to the after-sale service or to a dealer, its transport expenses must be borne by the customer. Shipment shall be however agreed upon.

A report must always accompany the returned product, stating the reasons of its return.

For shipping the instrument, exclusively use the original packaging material; any damage that may be due to non-original packing shall be charged to the customer.

The manufacturer disclaims any responsibility for damages caused to people and/or objects.

Guarantee is not applied in the following cases:

- Any repair and/or replacement of accessories and the battery (not covered by the guarantee).
- Any repair that might be necessary as a consequence of a misuse of the instrument or of its use with non compatible devices.
- Any repair that might be necessary as a consequence of improper packaging.
- Any repair that might be necessary as a consequence of service interventions carried out by unauthorised personnel.
- Any change to the instrument carried out without the express authorisation of the manufacturer.
- Use not provided for among the instrument specifications or in the instruction manual.

The content of this manual cannot be reproduced in any form whatsoever without express authorisation of the manufacturer.

All our products are patented and their trade marks registered. The manufacturer reserves the right to modify the product specifications and price, if this is aimed at a technological improvement.

11.2. SERVICE

If the instrument does not operate properly, before contacting the after-sale service check the cables and the test leads and replace them, if necessary. Should the instrument still operate improperly, check that the operation procedure is correct and corresponds to the instructions given in this manual. If the instrument is to be returned to the after-sale service or to a dealer, its transportation is on the customer's behalf. Shipment shall be however agreed upon. A report must always accompany the returned product, stating the reasons of its return. For shipping the instrument, exclusively use the original packaging material; any damage that may be due to non-original packing shall be charged to the customer.



Via della Boaria 40
48018 – Faenza (RA)- Italy
Tel:+39-0546-621002 (4 linee r.a.)
Fax:+39-0546-621144
Email: ht@htitalia.it
<http://www.ht-instruments.com>